

Running a Museum

A Practical Handbook



Running a Museum: A Practical Handbook



Running a Museum: A Practical Handbook



Running a Museum: A Practical Handbook

PUBLISHER:

ICOM – International Council of Museums
Maison de l'UNESCO
1, rue Miollis
75732 Paris Cedex 15
France

ICOM is very grateful to the United Nations Development Group Trust Fund (UNDG TF) for making this publication possible.

Editor and Coordinator: Patrick J. Boylan
ICOM Secretariat Coordination: Jennifer Thévenot
Layout and cover design: Edward Moody Design
Printer: Franly S.A.

Photo and other illustration credits:

Where not otherwise acknowledged the photographs, diagrams and other illustrations are by, and are the copyright of, the author of the chapter concerned. ICOM thanks both the authors and the other copyright owners for their support and cooperation.

© 2004, ICOM, all rights reserved

ISBN 92-9012-157-2

Contents

Foreword	v
<i>by Alissandra Cummins, President of ICOM</i>	
Introduction	vii
<i>by Patrick Boylan, Coordinator & Editor</i>	
The Role of Museums and the Professional Code of Ethics	1
<i>by Geoffrey Lewis</i>	
Historical background to collecting; The first public museums; Minimum standards & professional ethics; Managing the museum; Making and maintaining collections; Interpreting and furthering knowledge – accessibility; Appreciating and promoting the natural and cultural heritage; Public service and public benefit; Working with communities; Legislation; Professionalism.	
Collections Management	17
<i>by Nicola Ladkin</i>	
Developing a collections management policy; Acquisition and accessioning; Deaccessioning and disposals; Numbering and marking of objects in the collection; Loans condition reports; Collections storage; Handling and moving collections; Photography; Insurance; Public access to collections; Display and exhibition galleries and rooms; Research of collections.	
Inventories and Documentation	31
<i>by Andrew Roberts</i>	
Acquisitions, long-term loans and accessioning; Inventory control and cataloguing; Syntax and terminology; Object numbering, labelling and marking; Location and movement control; Backlog accessioning, inventory control and cataloguing; Manual and computer-based cataloguing and retrieval; Images; Web access to the information about the collection; Staff and Financial Resources; Recommended cataloguing fields.	
Care and Preservation of Collections	51
<i>by Stefan Michalski</i>	
Deciding priorities and assessing risks; Reducing future loss and damage in 100 years or more; Classifying risks to collections; The Nine Agents of Deterioration; The collection preservation cycle: Step 1: Check the basics – Step 2: Survey the risks – Step 3: Plan improvements to collection risk management; Examples of specific risk assessments and individual solutions; Integrated risk management of pests (IPM); Integrated, sustainable risk management of lighting, pollutants, temperature, and humidity; Museum lighting guidelines; Museum temperature and humidity guidelines; Museum pollutant guidelines; Integrating management of all four agents.	
Display, Exhibits and Exhibitions	91
<i>by Yani Herreman</i>	
Types of displays; The object: interpretation within the exhibition context; Exhibition management in relation to other museum activities; Design: the basic planning and designing process; Creating the planning brief; Developing the exhibition; Production and materials; Completing the exhibition; Evaluating the finished exhibition.	
Caring for the Visitor	105
<i>by Vicky Woollard</i>	
The benefits for museums?; What are the underpinning principles for providing quality visitor services; Some key issues to consider in developing a visitor services policy statement; Defining and understanding the visitor; Types of visitors and their needs; Planning and managing visitor services; Specific areas for attention; Checklist from the visitors' point of view.	

Museum Education in the Context of Museum Functions	119
<i>by Cornelia Brüninghaus-Knubel</i>	
Collections and education; Developing and managing museum education; Museum education and the community; Designing educational programs: the basic principles; Choice of teaching and learning methods in museum education; Museum publications; Types of didactic material commonly used in museums; Extra-mural activities; Informal education.	
Museum Management	133
<i>by Gary Edson</i>	
Management structure; Teamwork; Leadership styles of directors and other senior staff; Building a mission statement; Financial management; Six rules for planning a budget; Museum ethics and management; The planning process; Issues to be considered; Evaluation; SWOT analysis.	
Managing People	147
<i>by Patrick Boylan</i>	
Understanding personnel management; The main categories of museum work and museum employees; Personnel information, involvement and fairness; Recruiting and retaining high quality staff; Recruitment and promotion selection methods and approaches; Minimum requirements for a statement or contract of the terms of employment; Staff management, training and professional development; Disciplinary and grievance procedures; Health and safety at work; How to assess risks in the workplace: five steps in risk assessment.	
Marketing	161
<i>by Paal Mork</i>	
Introduction to marketing; The current orientation of museums in relation to marketing theory and practice; Product, price, promotion, place; Strategic market planning; Mission and vision; Internal and external factors; Target groups; Promotion; Advertising; Public relations; Building a museum "brand".	
Museum Security, including Disaster Preparedness	177
<i>by Pavel Jirásek</i>	
Who is responsible for security policy and its enforcement?; Risk analysis and the security plan; Implementing the strategic plan for museum protection; Measures to ensure security in display and exhibition rooms; Intruder Detection System (IDS); Access Control System (ACS); Closed Circuit Television (CCTV); Automatic fire detection and alarm system (FAS); The Emergency Plan.	
Illicit Traffic	197
<i>by Lyndel Prott</i>	
Prevention; Inventories; Object ID Checklist; National legislation; Tourists and visitors; Training; Detection; Recovery; International co-operation; International Conventions; Recovery where the Conventions do not apply; Litigation.	
Brief explanations of some key terms as they are used in this book	206
References and further information	212
Brief biographies of the Authors	217
ICOM Code of Professional Ethics	220

Foreword

Alissandra Cummins, President of ICOM

The preparation of this book, *Running a Museum: A Practical Handbook*, came about at the request of UNESCO's Intergovernmental Committee for the Safeguarding of the Cultural Heritage of Iraq. The need was felt for an elementary manual that could be used by trainers and trainees in courses on museum subjects, as a tool for persons already working in museums in Iraq, and as a reference document providing guidance for more in-depth study of particular aspects. It would also be of interest to laymen in understanding the basic aspects of running a museum.

However, recognising the usefulness of such a publication throughout the international museum community, UNESCO decided to broaden its scope and to make it available to all museums in the Arabic-speaking world, as well as in a simultaneous English edition for wider use.

This publication is another example of ICOM's direct response to the need to provide professional training and practical advice wherever it is needed. Indeed, in its almost sixty years of existence ICOM has sought to promote professional standards of professional training and practice in tandem with collaborative approaches to work. Today one of the organisation's stated objectives remains to advance "the sharing of professional knowledge and museum practice internationally through mutual assistance," while at the same time actively encouraging new models for collaboration. ICOM's key mission after establishing professional and ethical standards for museum activities is the promotion of training, and the advancement of knowledge. The authors of the twelve chapters have drawn on their wide range of museum experience and professional expertise while at the same time aptly representing the diverse and multi-cultural society/ties in which we now live.

I should like to acknowledge with grateful thanks the financial support of the United Nations Development Group Trust Fund for the production of this book. The invaluable contributions of all the writers working under the inspired editorship of Patrick J. Boylan, should also be recognized. Finally the staff of ICOM's programme sector played a key role in the preparation and coordination of this book. In my view they have together created an excellent tool for both academic and self-directed learning, one which will support the development of the museum profession globally for many years to come.

Alissandra Cummins, President
International Council of Museums (ICOM)

Introduction

Patrick J. Boylean

Running a Museum: A Practical Handbook is intended to provide an overview of the key aspects of the operation of a museum that is anxious to serve the needs and hopes of its visitors and the wider community in the 21st century.

Museums need to remain faithful to traditional core values of the museum and continue to emphasise the care and development of collections that provide physical evidence of the culture and environment of the museum's chosen territory, whether this be a single historic or archaeological site, a city, a region or a whole country. Equally, however, the contemporary museum needs to have a strong focus on seeking excellence in its services to its many publics, whether these are young school children, advanced students, general visitors for the locality, international or national tourists, or specialist researchers.

Running a Museum aims to serve several purposes. We hope that the information and advice on current "best practice" will be of practical value:

1. to new or future museum professionals with minimum experience so far of running a museum;
2. to experienced professionals and technicians in one of the many specialised areas of museum work by explaining to them about the responsibilities and work of their colleagues in other departments and specialisms;
3. as a valuable resource in the very necessary internal discussions among staff and governing authorities about the current performance and the future policy and direction of their own institution.

We want to emphasise that *Running a Museum* should not be regarded as either some sort of theoretical textbook nor as just a technical reference manual, though with its discussions of important issues of principle, and the many practical examples of "good practice" the authors hope that it will be of value in both museum professional training and career development and as a source of important technical information and advice. Instead, we hope that it will help the staff of museums in a process of internal reform and modernisation of both policy and practice within their own institutions.

At many points the reader will find practical exercises and important issues highlighted. Though some of these could be carried out as a solo exercise by the reader, these assignments are mainly designed for group discussion and practical exercises involving several members of the museum's staff. Ideally such study or working groups should be drawn from several different specializations, job positions and levels of responsibility within the institution so that several different perspectives are brought to bear on the question being studied. It is also hoped that these exercises will also be of value in more formal museum training and career development programmes.

A recurring theme through most of the chapters is the need for the staff of every museum to cooperate with each other and work together as a team, and to quickly develop an understanding of the work and responsibilities of everyone else working in the museum. We see this as a practical necessity in a world where there is increasing emphasis on decentralising managerial power and

responsibility within all organisations to the lowest practicable level within the hierarchy or staff structure.

The twelve contributors to this *Handbook*, drawn from different parts of the world, are each recognised experts in their own field, with between them many decades of both practical experience of working in the specialised field covered by their chapter, as well as much experience of advisory and teaching work with a wide range of museums and other heritage bodies throughout the world.

The aim of each chapter is to provide practical advice and points for discussion. The main text in each chapter is supported throughout by both supplementary information, including for example key technical data and standards, and suggestions for practical exercises and discussion topics for internal use, whether by an individual professional, a small study group, by participants in a training or staff development programme or exercise, or by the entire staff.

The chapter on the role of museums and of professional ethics introduces the common tradition, values, and standards of institutional and professional conduct that should lie behind all specialised activities within museums and related institutions and that should be the foundations on which everything else is built.

The next group of chapters offer a contemporary perspective on the core activity of museums, but one that has expanded in scale and complexity in recent years: the development, management, documentation, care and preservation of the collections.

Communication is also a very important museum function, and the role of display and exhibitions, the emerging professional field of visitor care, and of both formal and informal museum education and learning are examined in turn.

Traditionally, administration tended to be regarded as a relatively unimportant part of museum operations,

since most of the key administrative functions, such as the maintenance and the management of the museum buildings and of both financial and personnel operations, were most often the responsibility of the relevant specialist government or town hall departments.

However, the rapid trend towards the decentralisation of such functions, and therefore the transfer of such responsibilities to the museums themselves, has made both general and personnel management far more important, and a key responsibility of the director and other senior staff in particular. Also, marketing has become an important aspect of the work of museums today. With declining levels of public support, very many, probably most, museums now need to earn more and more of their running costs through fund-raising and income-generation activities.

Similarly, faced with the growth of international crime against cultural property of all kinds, including both museum collections and heritage sites, museum security concerns are increasingly important, as is the international struggle against illicit trafficking in stolen and illegally acquired and transferred antiquities, works of art, natural history specimens and other cultural property. This *Handbook* therefore concludes with chapters on these two important topics.

We hope that readers will find *Running a Museum: A Practical Handbook* challenging and thought-provoking in relation to their understanding of the role and future potential of the museum as a whole, and of the reader's actual and potential personal contribution to maintaining and improving its professional and public services.

The Role of Museums and the Professional Code of Ethics

Geoffrey Lewis

Chair, ICOM Ethics Committee

The Role of Museums

Museums look after the world's cultural property and interpret it to the public. This is not ordinary property. It has a special status in international legislation and there are normally national laws to protect it. It is part of the world's natural and cultural heritage and may be of a tangible or intangible character. Cultural property also often provides the primary evidence in a number of subject disciplines, such as archaeology and the natural sciences, and therefore represents an important contribution to knowledge. It is also a significant component in defining cultural identity, nationally and internationally.

Historical background to collecting

Collections of objects brought together because they have personal or collective associations occur in remote antiquity. Grave goods found with Palaeolithic burials provide evidence of this. However, development towards the museum idea occurs early in the second millennium BCE at Larsa in Mesopotamia where copies of old inscriptions were reproduced for educational use in the schools there. Archaeological evidence from the sixth century BCE levels at Ur suggest that not only were the kings Nebuchadrezzar and Nabonidus collecting antiquities at this time, also, about the same time, there was a collection of antiquities in a room next to the temple school which was associated with a tablet describing earlier brick inscriptions found locally. This could be considered to be a 'museum label'.

Despite the classical origins of the word 'museum', neither the Greek nor the Roman empires provide examples of a museum as we know them today. The votive offerings housed in the temples, sometimes in specially built treasuries, were normally open to the public, often on payment of a small fee. They included works of art, natural curiosities as well as exotic items brought from far-flung parts of the empire but were primarily a religious provision. The veneration of the past and of its personalities in Oriental countries also led to the collection of objects while relics were being accumulated at the tombs of early Muslim martyrs of which those dedicated to Imam-Reza at Meshed in north-west Iran is today housed in a museum near the tomb. The idea of al-waqf, involving the giving of property for the public good and for religious purposes, also resulted in the formation of collections.

In medieval Europe, collections were mainly the prerogative of princely houses and the church. Such collections had an economic importance and would be used to finance wars and other state expenses. Other collections took the form of alleged relics of Christendom. With the resurgence of interest in its classical heritage and facilitated by the rise of new merchant and banking families, impressive collections of antiquities were formed in Europe. Outstanding among the collections was that formed and developed by the Medici family in Florence and eventually bequeathed to the state in 1743 to be accessible 'to the people of Tuscany and to all nations'. Royal and noble collections

were also formed in many other European countries. By the seventeenth century, increasing interest into human as well as natural history led to the creation of many specialised collections by the intelligentsia of the day. This is also the period when the first scientific societies were established; and a number formed their own collections, the best known being Accademia del Cimento in Florence (1657), the Royal Society of London (1660) and the Academie des Sciences in Paris (1666). By this time systematic classifications for the natural and artificial world were available to assist collectors in ordering their collections. This reflects the spirit of system, rational enquiry and an encyclopaedic approach to knowledge now emerging in Europe.

The first public museums *Encyclopaedic museums*

It is in the encyclopaedic spirit of the so-called European Enlightenment that public museums emerge. The Ashmolean Museum, opened by the University of Oxford in 1683, is generally considered to be the first museum established by a public body for the public benefit. This was based largely on the eclectic collections, from many parts of the world, brought together by the Tradescant family and previously displayed to the public at their home in London. It was encyclopaedic in character and this is a feature of two other well-known museums of this early period: the British Museum, opened in London in 1759 and the Louvre, Paris, opened in 1793; both were government initiatives, the former resulting from the acquisition of three private collections and the latter from the "democratisation" of the royal collections.

Society museums

Learned societies were also among the early originators of public museums. This was particularly so in Asia. In



The British Museum was established by an act of parliament which stated that the museum was "not only for the inspection and entertainment of the learned and the curious, but for the general use and benefit of the public". It opened in 1759 in Montagu House, Bloomsbury (see above) specially purchased for the purpose. Public access was free from the outset, although initially it was necessary to apply for a ticket to gain admission. A visitor from France in 1784, observed that the Museum was expressly "for the instruction and gratification of the public".

The museum comprised classical antiquities, natural history specimens, manuscripts as well as ethnographic, numismatic and art material. The founding law reflected this encyclopaedic thinking of the time stating "all arts and sciences have a connexion with each other". But the natural history collections were moved out to form the Natural History Museum, which opened in 1881.

Jakarta the collection of the Batavia Society of Arts and Science was begun in 1778, eventually to become the Central Museum of Indonesian Culture. The origins of the Indian Museum in Calcutta are similar, being based on the collections of the Asiatic Society of Bengal which commenced in 1784. Both museums covered the arts and sciences and were concerned with furthering knowledge about their respective countries. In the United States, the Charleston Library Society of South Carolina announced its intention in 1773 of forming a collection of the 'natural productions, either animal



James Macie Smithson wished to see an institution established "for the increase and diffusion of knowledge among men". This was the beginning of the world-renowned scientific and educational facility known as the Smithsonian Institution in Washington DC. The legislation establishing it provided for a building to house an art gallery, library, chemical laboratory, lecture halls, and museum galleries; "all objects of art and curious research...natural history, plants, geological and mineralogical specimens" belonging to the United States were to be accommodated there. The Smithsonian's first building (pictured above) was completed in 1855 and the United States' National Museum opened three years later. The collections soon out-grew the building. Today, the Mall in Washington DC is lined with the specialist museums of the Smithsonian Institution.

vegetable or mineral' with a view to displaying the practical and commercial aspects of agriculture and medicine in the province.

National museums

The role of the museum in contributing to national consciousness and identity developed initially in Europe and with this the recognition that museums were the appropriate institutions for the preservation of a nation's historic heritage. This role continues today and is often emphasised in the national museums of newly established or re-established states. Nineteenth century expressions of this role include the national museum in Budapest, which originated in 1802 and was built from



One of the first museums in South America was founded in Buenos Aires in 1812 and opened to the public in 1823 as a museum of the country. It was housed in the university for many years. Now the Argentine Museum of Natural Sciences in Buenos Aires, it moved into its present building (above) in 1937. The collections cover all fields of natural and human history but are especially strong in paleontology, anthropology, and entomology.

money raised from voluntary taxes; it later became identified with the fight for Hungarian independence. In Prague a revival in nationalism led to the founding of the national museum in 1818 and its new building, not opened until 1891, became symbolic of the Czech national revival. Both initially housed collections from the arts and sciences but as the collections grew they were transferred to other buildings. In Hungary, for example, this led to the formation of specialised museums: Applied Arts, Fine Arts, National Culture and Natural Science.

Specialised museums

The concept of an encyclopaedic museum of national or global culture thus waned during the nineteenth century in favour of national museums of increasing



In 1835 an Antiquities Service was established by the Egyptian government to protect its archaeological sites and store the artefacts. A museum was formed in 1858 but the collection was not exhibited in a permanent building until the Egyptian Museum in Cairo was opened in 1902 (see above). Shortly after this, some of the collections were transferred to form two new well-known institutions, the Islamic Museum (1903) and the Coptic Museum (1908).

specialisation. This was accentuated where museums were also viewed as vehicles for promoting industrial design and technical achievement. International exhibitions of manufactures contributed to the formation of a number of such specialised museums, including the Victoria and Albert Museum and Science Museum in London, the Technisches Museum, Vienna and the Palais de la Decouverte in Paris.

General and local museums

The encyclopaedic idea, expressed now in general museums, remains a characteristic of many regional and local museums. These developed from the collections of private benefactors and societies particularly from the mid-nineteenth century. In Britain, municipal museums were seen as a means of providing instruction and



The Institute of Jamaica was established in 1879 for the encouragement of literature, science and art in Jamaica. By 1891 a science museum had been established and the following year a portrait gallery was opened. Today, it administers a number of history and ethnography museums in different parts of the island.

The science museum – now the natural history division – is in the headquarters building of the Institute in Kingston (above).

entertainment to the increasingly urbanised population and developed in the context of reforms to overcome social problems resulting from industrialisation. Where they were established at a port or other centre for international trade, the collections often reflected the global nature of this. These local and regional museums also had a role in promoting civic pride.



A few years following independence, the Nigerian government established a National Museums and Monuments Commission with responsibility for establishing national museums in the principal cities. This was part of a policy to promote the development of cultural identity and national unity. Some of these museums have developed workshops where traditional crafts can be demonstrated.

The Jos Museum, one of the earliest of the national museums, has developed a museum of traditional architecture (picture above).

Open Air museums

A new type of museum emerged in Sweden in 1872 to preserve aspects of the traditional folk-life of the nation with the creation of the Nordiska Museet at Stockholm. This was extended to collecting traditional buildings which were then re-erected at Skansen, the first open air museum. A variation to this theme has appeared in Nigeria where much of the traditional architecture is too fragile to move. Instead, craftsmen builders have been brought to the Museum of Traditional Architecture at Jos to erect examples of buildings representative of different parts of Nigeria.

Working museums

Other museums have developed workshops where traditional crafts can be demonstrated and sometimes exploited commercially for the benefit of the museum. Elsewhere workshops and industrial sites have been preserved in situ and restored to their former working

condition. In such cases the emphasis is more on preserving and maintaining historic processes rather than the equipment used to achieve them and to ensure a continuity of the skills associated with them.

It is at this level that intangible aspects of the heritage and the need to preserve them become particularly apparent. The detailed knowledge and the skills required to fabricate an object are best transmitted through oral and visual means and preserved through multimedia techniques. Such approaches can be applied widely in a number of museum situations.

Site museums

Where the site is being preserved in its own right, as with archaeological sites and areas of natural habitat, different criteria apply. There will be particular concern that the site can be maintained as far as possible in good condition having regard to environmental factors, including climate, and the impact that visitors might have on it. Interpretive facilities also need special treatment and how these can best be achieved unobtrusively both for the site and the finds from it.

Virtual museums

The availability of information and communication technologies bring new opportunities to the interpretative aspects of museums. This can manifest itself in a number of ways. For this purpose the opportunity to bring together digital images, particularly from diverse sources, in order to present and interpret the cultural and natural heritage and to communicate this to wider audiences must now be regarded an important role for museums.

Minimum Standards & Professional Ethics

Museum work is a service to society. It demands the highest standards of professional practice. The International Council of Museums (ICOM) sets

minimum standards in defining its Code of Ethics. These are used here to indicate the level of performance that both the public and colleagues might reasonably expect from all concerned with the provision and execution of museum services. These standards can be developed to meet particular local requirements and those of the specialist requirements of museum personnel.

Managing the museum

An effective museum service requires the confidence of the public it serves. All responsible for the care and interpretation of any aspect of the world's tangible and intangible cultural inheritance, whether at local or national level, need to foster this confidence. An important contribution to this is by creating public awareness of the role and purpose of the museum and the manner in which it is being managed.

Institutional standing

The protection and promotion of the public heritage requires that the institution is properly constituted and provides a permanence appropriate to this responsibility. There should be a written and published constitution, statute or other public document, which accords with national laws. This should clearly state the standing of the institution, its legal status, mission, permanence, and non-profit nature.

The strategic direction and oversight of the museum is normally the responsibility of the governing body. They should prepare and publicise a statement of the mission, objectives, and policies of the museum. They should also set out of the role and composition of the governing body.

Premises

To undertake the museum function requires adequate premises with a suitable environment to fulfil the basic functions defined in the governing body's mission. A museum and its collections should be available to all

during reasonable hours and for regular periods with appropriate standards to ensure the health, safety, and accessibility of its visitors and personnel. Particular regard should be given to access by persons with special needs.

Security

The nature of museum collections requires that the governing body provides appropriate security to protect the collections against theft or damage in displays, exhibitions, working or storage areas, and while in transit. Policies should also be in place to protect the public and personnel, the collections and other resources, against natural and man-made disasters.

The approach to insuring or indemnifying the resources of the museum may vary. However, the governing body should ensure that the cover is adequate and includes objects in transit or on loan and other items currently the responsibility of the museum.

Funding

It is the governing body's responsibility to ensure that there are sufficient funds to carry out and develop the activities of the museum. These funds may be from the public sector, from private sources or generated through the museum's own activities. There should be a written policy of acceptable practice for all funding sources and all funds must be accounted for in a professional manner.

Regardless of the funding source the museum must maintain control of the content and integrity of its programmes, exhibitions and activities. Income-generating activities should not compromise the standards of the institution or its public.

Personnel

The museum's personnel are an important resource. The governing body should ensure that all action concerning its personnel is taken in accordance with the policies of the museum as well as the proper and legal procedures in force locally.

Ethics – Case Study 1

You have been planning for years to organise an important exhibition in your subject but lack of funds has always prevented this. The press and television have publicised your need for a sponsor. To your surprise a large company writes offering to bear the full cost of the exhibition, subject to their name being associated with it in any publicity. You share this good news with a colleague who tells you that the local community are fighting a campaign against this company because they wish to develop a site of scientific interest which is also sacred to the first peoples of the area. How do you proceed?

The director or head of the museum is a key post and should be directly responsible, with direct access, to the governing body. When making such an appointment, governing bodies need to have regard for the knowledge and skills required to fill the post effectively. These qualities should include adequate intellectual ability and professional knowledge, complemented by a high standard of ethical conduct.

The museum function involves many different skills and qualified personnel with the expertise required to meet all responsibilities should be employed. There should also be adequate opportunities for their continuing education and professional development of museum personnel.

Some museums encourage volunteer help. In such cases the governing body should have a written policy on volunteer work which promotes a positive relationship between volunteers and museum personnel. Volunteers should be fully conversant with the *ICOM Code of Ethics* and other applicable codes and laws.

The governing body should never require museum personnel or volunteers to act in a way that could be

considered to conflict with the provisions of any national law or relevant code of ethics.

Making and maintaining collections

Acquisitions policy

Museums have the duty to acquire, preserve and promote their collections. These collections are a significant public inheritance and those involved with them hold positions of public trust. The governing body should therefore adopt and publish a written collections policy that addresses the acquisition, care and use of the collections.

Ethics – Case Study 2

You are trying to build a representative collection in your subject. There are a few gaps that you have yet to fill. You also have a number of specimens of the same type which have been given to the museum although their associations with people and places and other material are different. A local collector has two items which would help to complete your collection and he offers to exchange these for the items you have of the same type. What do you do?

The policy should also clarify the position of any material that will not be catalogued, conserved, or exhibited. For example, there may be certain types of working collections where the emphasis is on preserving cultural, scientific or technical process rather than the object, or where objects or specimens are assembled for regular handling and teaching purposes.

The acquisition of objects or specimens outside a museum's stated policy should only be made in exceptional circumstances. Where this is an issue, the governing body should consider the professional opinions available to them

and the views of all interested parties. Consideration should include the significance of the object or specimen, including its context in the cultural or natural heritage, and the special interests of other museums collecting such material. However, even in these circumstances, objects without a valid title should not be acquired.

Ownership

No object or specimen should be acquired, whether by purchase, gift, loan, bequest or exchange, unless the acquiring museum is satisfied that valid title of ownership is held. Evidence of lawful ownership in a country is not necessarily valid title. Every effort must, therefore, be made before acquisition to ensure that the object or specimen has not been illegally obtained in or exported from, its country of origin or any intermediate country in which it might have been owned legally (including the museum's own country). Due diligence in this regard may be taken as establishing the full history of the item from discovery or production.

Associated information

The context and associations of an object or specimen are also important as this often provides information which greatly enhances knowledge of the item. For this and legal reasons, material resulting from unauthorised or unscientific collecting, or the intentional destruction or damage of monuments, archaeological or geological sites, or species and natural habitats should not be acquired. In the same way, acquisition should not occur if there has been a failure to disclose the finds to the owner or occupier of the land, or to the proper legal or governmental authorities. Similarly biological or geological specimens that have been collected, sold, or otherwise transferred in contravention of local, national, regional or international law or treaty relating to wildlife protection or natural history conservation should not be acquired.

There will be instances where a museum may have to act as an authorised repository for unprovenanced, illicitly collected or recovered specimens and objects from the territory over which it has lawful responsibility. It should only do so with all necessary governmental authority.

Sensitive material

Care is necessary in acquiring certain objects or specimens for which there may be particular sensitivities, either culturally or biologically. Collections of human remains and material of sacred significance should be acquired only if they can be housed securely and cared for respectfully in a manner consistent with professional standards and the interests and beliefs, where known, of members of the community, ethnic or religious groups from which the objects originated.

Special considerations are also necessary for the natural and social environment from which live botanical and zoological specimens are derived as well as any local, national, regional or international law, or treaty relating to wildlife protection or natural history conservation.

Removing objects and specimens from museum collections

The permanent nature of museum collections and the dependence on private benefaction in forming collections makes any removal of an item a serious matter. For this reason many museums do not have legal powers to dispose of specimens.

Where there are legal powers permitting disposals, the removal of an object or specimen from a museum collection must only be undertaken with a full understanding of the significance of the item, its character (whether renewable or non-renewable), legal standing, and any loss of public trust that might result from such action. The decision to de-accession should be the responsibility of the governing body acting in conjunction with the director of the museum and the curator of the collection concerned.

In the case of collections subject to conditions of disposal, the legal or other requirements and procedures must be complied with fully. Where the original acquisition was subject to mandatory or other restrictions these conditions must be observed unless it can clearly be shown that adherence to such restrictions is impossible or substantially detrimental to the institution. If appropriate, relief should be obtained through legal procedures.

The museum's policy on de-accessioning should define the authorised methods for permanently removing an object from the collections. This may be through donation, transfer, exchange, sale, repatriation, or destruction. It will allow the transfer of unrestricted title to the receiving agency. Because museum collections are held in public trust they may not be treated as a realisable asset. Money or compensation received from the de-accessioning and disposal of objects and specimens from a museum collection should be used solely for the benefit of the collection and usually for acquisitions to that collection.

Complete records must be kept of all de-accessioning decisions, the objects involved, and the disposition of the object. There will be a strong presumption that a de-accessioned item should first be offered to another museum.

Conflicts of interest

Special care is required in considering any item, either for sale, as a donation or as a tax-benefit gift, from a member of your governing body, a colleague, or the families and close associates of these persons. Such persons should not be permitted to purchase objects that have been deaccessioned from a collection for which they are responsible.

Museum policies should ensure that the collections (both permanent and temporary) and associated information, properly recorded, are available for current

usage and will be passed on to future generations in as good and safe a condition as practicable, having regard to current knowledge and resources. Professional responsibilities involving the care of the collections should be assigned to persons with the appropriate knowledge and skill or who are adequately supervised.

Documentation of collections

The importance of the information associated with museum collections requires that this should be documented according to accepted professional standards. This should include a full identification and description of each item, its associations, provenance, condition, treatment and present location. Such data should be kept in a secure environment and be supported with retrieval systems providing access to the information by the museum personnel and other legitimate users. The museum should avoid disclosing sensitive personal or related information and other confidential matters when collection data are made available to the public.

Protection against disasters

The nature of museum collections demand that every museum should develop policies to ensure the protection of the collections during armed conflict and other man-made and natural disasters and emergencies.

Preventive conservation

Preventive conservation is an important element of museum policy and collections care. It is an essential responsibility of members of the museum profession to create and maintain a protective environment for the collections in their care, whether in store, on display or in transit.

Conservation and restoration

The museum should carefully monitor the condition of collections to determine when an object or specimen may require conservation-restoration work and the

services of a qualified conservator-restorer. The principle goal should be the stabilisation of the object or specimen. All conservation procedures should be documented and as reversible as possible, and all alterations should be clearly identifiable from the original object or specimen.

Welfare of live animals

A museum that maintains living animals must assume full responsibility for their health and well-being. It should prepare and implement a safety code for the protection of its personnel and visitors - as well as the animals - that has been approved by an expert in the veterinary field. Genetic modification should be clearly identifiable.

Personal use of museum collections

Museum personnel, the governing body, their families, close associates, or others should not be permitted to appropriate items from the museum collections, even temporarily, for any personal use.

Interpreting and furthering knowledge – accessibility

Primary evidence

Museums hold the primary evidence for a number of subject disciplines. They have particular responsibilities to all for the care, accessibility and interpretation of this material held in their collections.

The museum collections policy should indicate clearly the significance of collections as primary evidence. This should verify that it is not governed by current intellectual trends or museum usage.

Availability

Museums have a particular responsibility for making collections and all relevant information available as freely as possible, having regard to restraints arising for reasons of confidentiality and security.

Ethics – Case Study 3

You have been undertaking research on a topic to do with your collections which will eventually provide the basis for a major exhibition. Some of your findings provide new evidence which is likely to attract considerable publicity for the exhibition. Before you have had an opportunity to publish your work or prepare the exhibition, a doctoral student calls to study the same collections. What information do you make available to her?

Field collecting

If museums undertake their own field collecting, they should develop policies consistent with academic standards and applicable national and international laws and treaty obligations. Fieldwork should only be undertaken with respect and consideration for the views of local communities, their environmental resources and cultural practices as well as efforts to enhance the cultural and natural heritage.

Exceptional collecting of primary evidence

In very exceptional cases an item without provenance may have such an inherently outstanding contribution to knowledge that it would be in the public interest to preserve. The acceptance of such an item into a museum collection should be the subject of a decision by specialists in the discipline concerned and without national or international prejudice.

Research

Research on primary source material by museum personnel should relate to the museum's mission and objectives and conform to established legal, ethical and academic practices.

Occasionally research involves destructive analytical techniques. These should be kept to a minimum. When

undertaken, a complete record of the material analysed, the outcome of the analysis, and the resulting research, including publications, should become a part of the permanent record of the object.

Research involving human remains and materials of sacred significance must be accomplished in a manner consistent with professional standards and take into account the interests and beliefs of the community, ethnic or religious groups from whom the objects originated, where these are known.

Rights to research findings

When museum personnel prepare material for presentation, or to document field investigation, there must be clear agreement with the sponsoring museum regarding all rights to the work.

Co-operation between institutions and personnel

Museum personnel should acknowledge and endorse the need for co-operation and consultation between institutions with similar interests and collecting practices. This is particularly so with institutes of higher education and certain public utilities where research may generate important collections for which there is no long-term security.

Museum personnel also have an obligation to share their knowledge and experience with colleagues, scholars and students in relevant fields. They should respect and acknowledge those from whom they have learned and should pass on such advancements in techniques and experience that may be of benefit to others.

Appreciating and promoting the natural and cultural heritage

Museums have an important duty to develop their educational role and attract wider audiences from the community, locality, or group they serve. Interaction with the constituent community and promotion of their heritage is an integral part of the educational role of the museum.

Displays and exhibitions

Displays and temporary exhibitions, physical or electronic, should be in accordance with the stated mission, policy and purpose of the museum. They should compromise neither the quality nor the proper care and conservation of the collections.

The information presented in displays and exhibitions should be well-founded, accurate and give appropriate consideration to represented groups or beliefs.

Ethics – Case Study 4

A local collector has one of the finest private collections of material relating to your subject, even though he holds unorthodox views about it. You have fostered good relations with him in the hope that your museum might benefit from this. One day he offers to lend his collection for a temporary exhibition at the museum's expense, subject to two conditions: that the exhibition only shows material from his collection and that he must be responsible for all label and publication content. Do you accept his offer?

The display of human remains and material of sacred significance should be exhibited in a manner consistent with professional standards and, where known, take into account the interests and beliefs of members of the community, ethnic or religious groups from whom the objects originated. Such material must be presented with great tact and respect for the feelings of human dignity held by all peoples. Requests for removal from public display of such material must be addressed expeditiously with respect and sensitivity. Requests for the return of such material should be addressed similarly. Museum policies should clearly define the process for responding to such requests.

Display of unprovenanced material

Museums should avoid displaying or using material of questionable origin or lacking provenance. They should be aware that displays or usage of such material can be seen to condone and contribute to the illicit trade in cultural property.

Publication and reproductions

Information published by museums, by whatever means, should be well-founded, accurate and give responsible consideration to the academic disciplines, societies, or beliefs presented. Museum publications should not compromise the standards of the institution.

Museums should respect the integrity of the original when replicas, reproductions, or copies of items from the collection are made or used in display. All such copies should be clearly labelled and permanently marked as facsimiles.

Public service and public benefit

Museums use a wide variety of specialisms, skills and physical resources which have a far wider application than in the museum. This may lead to shared resources or the provision of services as an extension of the museum's activities. They should be organised in such a way that they do not compromise the museum's stated mission.

Identification of objects and specimens

Museums often provide an identification or opinion service for the public. Care is necessary to ensure that the museum or individual does not act in any way that could be regarded as benefiting from such activity, directly or indirectly. The identification and authentication of objects that are believed or suspected to have been illegally or illicitly acquired, transferred, imported or exported should not be made public until the appropriate authorities have been notified.

Authentication and valuation (Appraisal)

Valuations of museums collections may be made for insurance or indemnity purposes. Opinions on the monetary value of other objects should only be given on official request from other museums, or competent legal, governmental or other responsible public authorities. However, when the museum may be the beneficiary, appraisal of an object or specimen must be undertaken independently.

Working with communities

Museum collections reflect the cultural and natural heritage of the communities from which they have been derived. As such they have a character beyond that of ordinary property which may include strong affinities with national, regional, local, ethnic, religious or political identity. It is important therefore that museum policy is responsive to this.

Co-operation

Museums should promote the sharing of knowledge, documentation and collections with museums and cultural organisations in the countries and communities from which they originate. The possibility of developing partnerships with museums in countries or areas that have lost a significant part of their heritage should be explored.

Return of cultural property

Museums should be prepared to initiate dialogues for the return of cultural property to a country or people of origin. This should be undertaken in an impartial manner, based on scientific, professional and humanitarian principles as well as applicable local, national and international legislation, in preference to action at a governmental or political level.

Restitution of cultural property

A country or people of origin may seek the restitution of an object or specimen that can be demonstrated to have

been exported or otherwise transferred in violation of the principles of international and national conventions. If it can be shown to be part of that country's or people's cultural or natural heritage, the museum concerned should, if legally free to do so, take prompt and responsible steps to co-operate in its return.

Cultural objects from occupied countries

Museums should abstain from purchasing or acquiring cultural objects from an occupied territory. They should respect fully all laws and conventions that regulate the import, export and transfer of cultural or natural materials.

Contemporary communities

Museum activities frequently involve a contemporary community and its heritage. Acquisitions should only be made based on informed and mutual consent without exploitation of the owner or informants. Respect for the wishes of the community involved should be paramount.

Use of collections from contemporary communities requires respect for human dignity and the traditions and cultures from which they are derived. Such collections should be used to promote human well-being, social development, tolerance, and respect by advocating multi-social, multi-cultural and multi-lingual expression.

Funding of community facilities

Care should be taken when seeking funds for activities involving contemporary communities to ensure that their interests will not be compromised by the associations of potential sponsors.

Supporting organisations in the community

Museums should create a favourable environment for community support (e.g. Friends of Museums and other supporting organisations), recognise its contribution and promote a harmonious relationship between the community and museum personnel.

Legislation

Museums must conform fully to international, regional, national or local legislation and treaty obligations in force in their country. In addition, the governing body should comply with any legally binding trusts or conditions relating to any aspect of the museum, its collections and operations.

National and local legislation

Museums must conform to all national and local laws. They should also respect the legislation of other states as they affect their operation.

International legislation

The ratification of international legislation varies between different countries. Museum policy should, however, acknowledge the following international legislation which is taken as a standard in interpreting the ICOM Code of Ethics:

Convention for the Protection of Cultural Property in the Event of Armed Conflict (the Hague Convention), 1954, Protocol [now First Protocol], 1954 and Second Protocol, 1999.

UNESCO Convention on the Means of Prohibiting and Preventing the Illicit Import, Export and Transfer of Ownership of Cultural Property (1970);

Convention on International Trade in Endangered Species of Wild Fauna and Flora (1973);

UN Convention on Biological Diversity (1992);

Unidroit Convention on Stolen and Illegally Exported Cultural Objects (1995);

UNESCO Convention on the Protection of the Underwater Cultural Heritage (2001);

UNESCO Convention for the Safeguarding of the Intangible Cultural Heritage (2003).

Professionalism

Members of the museum profession should observe accepted standards and laws and uphold the dignity and honour of their profession. They should safeguard the public against illegal or unethical conduct. Every opportunity should be used to inform and educate the public about the aims, purposes, and aspirations of the profession to develop a better public understanding of the contributions of museums to society.

Familiarity with relevant legislation

Every member of the museum profession should be conversant with relevant international, national and local legislation and the conditions of their employment. They should avoid situations that could be construed as improper conduct.

Professional responsibility

Members of the museum profession have an obligation to follow the policies and procedures of their employing institution. However, they may properly object to practices that are perceived to be damaging to a museum or the profession and matters of professional ethics.

Professional conduct

Loyalty to colleagues and to the employing museum is an important professional responsibility and must be based on allegiance to fundamental ethical principles applicable to the profession as a whole. They should comply with the terms of the *ICOM Code of Ethics* and be aware of any other codes or policies relevant to museum work.

Academic and scientific responsibilities

Members of the museum profession should promote the investigation, preservation, and use of information inherent in the collections. They should, therefore, refrain from any activity or circumstance that might result in the loss of such academic and scientific data.

Illicit traffic and market

Members of the museum profession should not support

the illicit traffic or market in natural and cultural property, directly or indirectly.

Confidentiality

Members of the museum profession must protect confidential information obtained during their work. Information about items brought to the museum for identification is confidential and should not be published or passed to any other institution or person without specific authorisation from the owner. Details about the security of the museum or of private collections and locations visited during official duties must be held in strict confidence.

Confidentiality is subject to a legal obligation to assist the police or other proper authorities in investigating possible stolen, illicitly acquired, or illegally transferred property.

Personal independence

Members of a profession are entitled to a measure of personal independence, but they must realise that no private business or professional interest can be wholly separated from their employing institution.

Professional relationships

Members of the museums profession form working relationships with numerous other persons within and outside the museum in which they are employed. They are expected to render their professional services to others efficiently and to a high standard.

Professional consultation

It is a professional responsibility to consult other colleagues within or outside the museum when the expertise available is insufficient in the museum to ensure good decision-making.

Gifts, favours, loans or other personal benefits

Museum employees must not accept gifts, favours, loans, or other personal benefits that may be offered to them in connection with their duties for the museum.

Occasionally, professional courtesy may include the giving and receiving of gifts but this should always take place in the name of the institution concerned.

Outside employment or business interests

Members of the museum profession, although entitled to a measure of personal independence, must realise that no private business or professional interest can be wholly separated from their employing institution. They should not undertake other paid employment or accept outside commissions that are in conflict with, or may be viewed as being in conflict with the interests of the museum.

Ethics - Case Study 5

You are a specialist in your subject and your museum encourages its staff to publish academic papers. A commercial gallery, from which your museum occasionally purchases well-documented material for the collections, is now putting on a prestigious exhibition in your subject. The director of the gallery has invited you to write an authoritative introduction to the exhibition catalogue. When you see the list of items included in the exhibition, some have no provenance and you suspect they may have been obtained illegally. Do you accept the invitation?

Dealing in natural or cultural heritage

Members of the museum profession should not participate directly or indirectly in dealing (buying or selling for profit), in the natural or cultural heritage.

Interaction with Dealers

Museum professionals should not accept any gift, hospitality, or any form of reward from a dealer, auctioneer, or other person as an inducement to purchase or dispose of museum items, or to take or refrain from taking official action. Furthermore, a museum

professional should not recommend a particular dealer, auctioneer, or appraiser to a member of the public.

Private collecting

Members of the museum profession should not compete with their institution either in the acquisition of objects or in any personal collecting activity. If a museum professional engages in any private collecting, an agreement between the museum professional and the governing body concerning this must be formulated and scrupulously followed.

Other conflicts of interest

Should any other conflict of interest develop between an individual and the museum, the interests of the museum should prevail.

Use of the name and logo of ICOM

It should also be noted that members of ICOM may not use of the words “International Council of Museums”, “ICOM” or its logo to promote or endorse any for-profit operation or product.

Summary

Museums have an active and multiple role in society. Through a diversity of provision there is a common purpose. This is the preservation of society’s collective memory as expressed tangibly and intangibly through the cultural and natural heritage. To do this, however, is meaningless unless it is associated with access to and the interpretation of that memory. Museums provide therefore for the sharing, appreciation and understanding of our inheritance.

Those responsible for providing museums and those who engage in providing all aspects of the museum service undertake a public responsibility. This should condition their behaviour, particularly as that responsibility is not necessarily contained within administrative or political boundaries or those of

academic disciplines. The ICOM Code of Ethics provides minimum standards that may be regarded as a reasonable public expectation and against which museum practitioners can assess their performance.

Collections Management

Nicola Ladkin

Adjunct Professor, Texas Tech University, Lubbock, Texas

Just as museum management is vitally important for the development and organization of each museum, so is collections management vital to the development, organization and preservation of the collections that each museum curates. Although museum collections may be very different from one another in content, they share other similar characteristics. They all contain large numbers of individual items, many different kinds of objects, specimens, artworks, documents, and artefacts, and all are representative of the “natural, cultural, and scientific heritage” (ICOM Code of Ethics for Museums, 2004). Specifically, many museum collections are large and complicated. This chapter is an introduction to best professional practice in developing, organising and preserving collections, with the aim of ensuring that the collections are managed and cared for properly.

Collections management is the term applied to the various legal, ethical, technical, and practical methods by which museum collections are assembled, organized, researched, interpreted, and preserved. Collections management focuses on the care of collections with concern for their long-term physical well-being and safety. It is concerned with issues of preservation, use of collections, and record keeping, as well as how the collections support the museum’s mission and purpose. The term collections management also is used to describe the specific activities undertaken in the management process.

Managing collections effectively is critical to ensuring that the collections support the museum’s mission. This

also is vital in order to make the most of the always-limited resources of time, money, equipment, materials, physical space, and staff. Equally, collections management needs to be based upon clearly defined policy and procedures that guide every-day decision-making and activities.

Introducing Collections Management

Box 1: The three key inter-related elements of collections management:

Registration of collections provides baseline institutional accountability for the many and various objects, artefacts, specimens, samples, and documents that the museum holds in trust for current and future generations of humanity.

Preservation of collections is an important, active aspect of collections management that underlies all other museum activities.

Providing controlled access to collections through exhibit or research fulfils the museum’s mission to educate and interpret while protecting collections at the same time.

Addressing registration, preservation and access issues in writing can also be used to provide a framework for the collections management policy.

Collections Management Policy

In order for collections management to function successfully, decisions about the museum’s collections

must always be made after careful consideration and in a consistent way. Good decision-making is founded on good policy. For this reason, the most important museum collections document is the Collections Management Policy. Building on the museum's mission statement and other key policy documents, the museum's overall purpose and goals are met by collection, research and preservation of its collection. Once written, the collections management policy serves as both a practical guide for the museum's staff, and as a public document explaining how the museum takes responsibility for the collections in its care.

The Collections Management Policy is considered to be such an important document that it has its own section in the ICOM Code of Ethics for Museums, which states that the governing body for each museum should adopt and publish a written collections policy that addresses the acquisition, care, and use of collections. Thus, having a collections management policy is considered to be a professional, ethical responsibility.

Developing a collections management policy

Before you begin to develop a collection management policy statement, several factors should be addressed and incorporated. Developing and drafting the policy is an opportunity to review and set down the museum's goals and how they are achieved if this has not already been done, and all staff members should be invited to contribute at this stage. The policy must be clearly written so it can be a useful guide to staff and the public. It must address the needs of the collections in relation to the overall goals of the museum. Also, it should include provisions for periodic review and updating.

The collections management policy may address a wide range of collections management subjects that can be chosen and written specifically to fit the needs of your

museum. However, certain key subjects should be addressed. As already stated in Box 1 above, these subjects can be grouped under the headings of registration, preservation of collections, and access to collections.

Box 2, which follows, contains a suggested outline for a Collections Management Policy for a typical collections-based museum. Most of the subjects listed are discussed in detail later in this chapter and a number of points that can be included under each subject in your collections management policy and procedure documents are provided. These comments address the basic and more general points, but you will want to include whatever additional information as is necessary and useful for the circumstances of your museum and its particular collections.

The importance of the museum having a clearly defined mission and purpose, and of adhering to a recognised Code of Ethics are both stressed in other earlier chapters. These are of course vitally important documents from a collections management perspective as they directly influence the composition of collections and affect their management and use. The collections management policy, along with related key policy statements such as documentation, preventive conservation, and disaster preparedness may exist as separate documents or be included as major sections in the general policy documentation of the institution, depending on the preference of the museum.

The ICOM Code of Ethics for Museums can provide direct assistance with developing the collections management policy. Section Two, entitled "Museums that maintain collections hold them in trust for the benefit of society and its development", directly addresses the critical elements of collections management, and reference to it throughout the drafting process will provide much helpful guidance.

Box 2: Drafting a Collections Management Policy: Suggested Table of Contents

Museum Mission and Purpose	Disaster Preparedness
Code of Ethics	Insurance
Registration	Access to Collections
Acquisitions and accessioning	Security
Valid title, provenance, and due diligence	Exhibitions
Sensitive and protected materials	Controlled environment
Appraisals and authentications	Monitoring collections on exhibit
Deaccessioning and disposals	Suitable exhibit materials
Return and restitution	Packing and shipping
Cataloguing, numbering, and marking	Research
Inventory	Field Collecting
Loans	In-house
Condition reporting and glossary/standards	Visiting scholars and researchers
Documentation	Destructive analysis
Preservation of Collections	Personal collecting and personal use of collections
Collections storage	Preventive Conservation
Collections handling and moving	Conservation
Photography	

Exercise 1: Examine this suggested collections management policy table of contents in the box above. What subjects are relevant for use in your museum? Are there any subjects that are irrelevant? What is special about your museum that would require the addition of other subjects? What would these subjects be? Summarise your conclusions and use these as the outline for the collections management policy for your museum.

Collections management procedures

Collections management procedures are the various activities by which collections management policies are converted into specific management actions. Procedures are most useful and provide consistency of action when formalized into a written document. Procedures are needed to implement all areas of policy. Subjects for written procedures most usefully will mirror the subjects

that are addressed in the collections management policy. As with the collections management policy, procedures can be written specifically for and customized to fit the needs of your museum.

Registration

Museum registration is concerned with the policies and procedure by which collections are acquired and

formally entered into the register of the holding of the museum, and how they are managed, tracked, and sometimes even disposed of after that point.

Acquisition and Accessioning

These are the methods by which a museum obtains its collections. The most common methods are gift, bequest, and purchase, exchange, field collection, and any other means by which title (ownership) is transferred to the museum. It is very important that criteria are established to determine what is collected. All objects and collections acquired must have good title, must support the goals of the museum and be free from conditions or restrictions on their use. The museum also must be able to provide for their long-term care and preservation.

Suggestions for Acquisition Policy (see also the Ethics chapter)

Acquisition is the process of obtaining an object or collection for the museum. Objects can be acquired in many different ways, such as from fieldwork, as a donation or bequest, or as a transfer from another institution. Irrespective of how a collection is acquired, there are ethical and legal components to acquisition that must be addressed. From an ethical perspective, the ICOM Code of Ethics for Museums specifies that museums should adopt a written collections management policy that addresses ethical aspects of acquisition. The acquisition policy should address such concerns as relevance of the collection to the museum's mission, completeness of its associated documentation, and special requirements for culturally and scientifically sensitive materials. Legally, the acquisition policy should state that acquisitions must not violate any local, state, national, and international laws and treaties.

Suggestions for Acquisition Procedure (see also the Documentation chapter)

Accessioning is the formal acceptance of an object or collection, recording it into the register of a museum,

and incorporating it into the museum's collections. Accessioning is initiated by receipt of documents that transfer title. Usually only objects that are acquired for the permanent collections are accessioned, in contrast to other objects the museum may obtain for use as exhibit props, in educational programmes and other expendable or programme support purposes.

The accession procedure begins with assigning a unique identifying number to an object or collection as it is entered into the museum's register. Under a commonly found system this number typically consists of an acronym for the museum, the current year date, followed by the consecutive number in order of which the collection was received, all separated by a dot or a dash. For example, the twentieth accession in 2004 at the National Archaeological Museum would have the accession number NAM-2004-20. All objects and documents relating to the accession are gathered together and are marked with the accession number for that particular accession. For more information on numbering and marking see the section below.

Documenting museum collections is a vital part of collections management. Registration records are the first produced when a collection enters the museum. Accession files contain all of the documents relating to each accession. Organisation and titling of files may vary depending on how the museum itself is organised and whether it uses paper, electronic, or both types of records and files. Whatever system is used, accession records are highly important legal, administrative and curatorial documents which will contain information on the donor or source of collections, evidence of legal title, insurance valuation information, condition reports, an inventory for accessions containing more than one object, photography, insurance, and any other relevant documents. For more details of accessioning and other documentation procedures see the Documentation chapter.

Deaccessioning and Disposals (see also the Ethics chapter).

Deaccessioning is the process of permanently removing objects from the museum register and collections. It is carried out for a variety of reasons, from refining the focus of the collection, to repatriation of objects, to removal of unsalvageable, deteriorated, infested objects. Because museums fulfil a public trust, deaccessioning can be controversial. Many museums are prohibited from deaccessioning by national laws or in their own governing charter or institutional policies. However, every museum should have a process for deciding on and recording legally permissible disposals.

Disposal is the act of physically removing deaccessioned collections objects from the museum and relocating them elsewhere. Depending on applicable law, disposal options may include transfer to another museum or similar institution for educational purposes, physical destruction of deteriorated objects, and restitution to another group or people.

Cataloguing, numbering, and marking

Cataloguing is the process of identifying in descriptive detail each collections object and assigning it a unique identifying number. All objects in the permanent collections should be catalogued.

Catalogue information should include descriptive details, classification or other identification, physical dimensions, provenance (origin and history of the object in terms of location of find, previous ownership, and means of acquisition), the accession number, and storage location. The catalogue entry may also include a photograph or sketch, and any other additional applicable information.

Numbering and marking of objects in the collection

Numbering and marking collections is the process of associating a unique identifying number with a collections object and marking or labelling the object

Box 3: Possible Contents of a Deaccessioning and Disposal Policy

- 1 A statement on how deaccessions and disposals are evaluated.
- 2 The authority to approve deaccessions is assigned to a particular committee or group.
- 3 Suggestions for Deaccessioning and Disposal Procedure.
- 4 Actions to deaccession and dispose of an object or collection is based on the policy as defined in the written Collections Management Policy of the museum.
- 5 Reasons for deaccessioning and disposal are made part of the collections records and are retained by the curatorial facility.
- 6 When, where, by whom, and under what authority deaccessioning and disposal is carried out is identified.
- 7 Deaccession records include written evaluation and justification for deaccession, date of deaccession, inventory of objects/collections deaccessioned, and method of disposal.
- 8 All records are kept permanently but are marked as “Deaccessioned”.

Box 4: Outline policy statement for Cataloging Procedure

- 1 Objects are catalogued to make a record of their physical attributes and provenance (see also the Documentation chapter, particularly the summary of the international “Object I.D.” system of object description).
- 2 Identifying catalogue numbers are assigned and applied to all objects.
- 3 If the museum conducts, or is associated with, archaeological excavations and similar fieldwork, every effort should be made to integrate the field recording with the permanent cataloguing, e.g. by using the museum’s accession numbering and cataloguing systems.
- 4 Objects are always catalogued before they are allowed to leave the museum on loan.
- 5 Cataloguing is carried out as soon as possible to avoid backlog.
- 6 Where, nevertheless, there is a backlog of accessioning and cataloguing, the museum should develop and implement a plan for bringing the cataloguing up to an acceptable standard as quickly as possible.

with that number. The number may be an accession number or a catalogue number. It is done so that objects can uniquely be identified.

The marking method must be permanent so that the number does not wear off, yet be reversible so that it can be removed if necessary. This is achieved on smooth surfaced objects by applying a basecoat of stable material such as polyvinyl acetate solution, writing the number on top of the basecoat, and sealing the number with a topcoat after it is dry. Position the number in a place where it will not obscure detail or impede research or exhibit viewing. Never mark the number directly on the surface of any object.

Textiles and other objects that cannot be marked directly can be labelled with hanging tags or sewn labels. Framed two dimensional objects can have hanging tags attached to their hooks or wires. Tags or labels must be made from archival materials and be attached in such a way that they do not damage the object. Care must be taken that tags do not become disassociated from their objects.

Some very small and fragile objects such as coins, jewellery, and natural history specimens such as insects cannot be marked directly or have labels attached to them. Such objects should be placed in a container such as a sleeve, envelope, tray, box, vial, or bag made from archival material (see the section on collections storage in this chapter). A number can then be marked directly on the container, or on a label that can be placed inside the container with the object. A label inside the container should be marked with pencil rather than ink to prevent accidental transfer of the ink.

Unframed two-dimensional objects, photographs, books, and documents can be placed in boxes, folders, or between paper or board. A number can then be written in pencil on the enclosing material.

Some museums are using bar code technology to mark

objects, usually in conjunction with the accession or catalogue number. This greatly assists in inventory procedures. The technology that produces the number and the label obviously is different, but the basic principles and procedures discussed above are the same when marking and labelling with bar codes.

Loans

Loans are the temporary removal or reassignment of an object or collection from its normal ownership or location. An incoming loan is borrowed by the museum from a lender – its owner or other normal holder, which can be another museum or an individual. It involves a change of location of objects and collections but not of title (legal ownership). An outgoing loan is the opposite: it involves lending out to another museum's collections. Again there is a change of location, but not of title. Many museum laws or regulations prohibit outward loans to individuals or private corporations, and even without formal restrictions are usually discouraged because an individual may not be able to care for and keep an item from a collection safe. On the other hand loans to other public or educational institutions allow museums to share their collections and enhance and support exhibitions and research projects that fulfil their educational goals. Unfortunately, experience shows that loans place extra physical stress on objects due to their being packed, shipped and handled more than usual, and also increase the security and other risks. For these reasons it is very important that requests for loans are considered carefully. In particular only objects that an experienced specialist conservator/restorer consider to be stable and not at significant risk from additional handling and transportation etc. should be loaned.

Experience shows that disputes can occur over loan arrangements and terms, so it is very important that loans are fully documented so that both borrower and lender understand in detail all the conditions of the loan. Records

of loans also must be tracked so that these can be closed when the object is returned: this is achieved through the use of a standardized loan document. The agreements and other documentation for both outward and inward loans should be assigned a unique loan number. In the case of inward loans this loan number can be processed and treated in very much the same way as an accession number while the object is in the museum. All documentation concerning both inward and outward past loans should be retained permanently in the case of outward loans from the collection, and for an extended period of time (at least ten years) if not permanently in the case of loans to the museum.

Condition Reports

The Condition Report is a document composed of a written and visual description of an object's appearance, state of preservation, and any defects, at a particular point in time. The first condition report should be made when an object is accessioned (or received on loan). It then is updated each time the object is involved in any activity, such as inclusion in an exhibition or display or before and after an outward loan. By doing this, any damage that has occurred will immediately be noticed. The condition report also should be updated after any accidental damage and before conservation treatment is carried out.

The most useful format for a condition report is a standardized document that prompts staff to collect the same information each time the report is made. A glossary of descriptive terms is also very useful for this purpose. If a specific technical term is not known, a detailed description of what is observed is helpful.

Examine the object in a clean, well-lit area. A flashlight and magnifying glass will help to show small details. Carefully inspect all areas of the object, but do not force open anything that may be closed or folded. Make a written record of what is observed and photograph or sketch anything unusual and any evidence of damage.

Box 5: Loans – policies and procedures

Outline Policy Statement on Loans

- 1 Loans are for the purpose of research, education, exhibition, conservation, or inspection
- 2 Loans are for a specified period of time, though they may be renewed or extended by mutual agreement
- 3 Loan documents should state any special requirements for the loan
- 4 Outgoing loans are made only to appropriate institutions
- 5 Incoming loans may be borrowed from institutions and individuals.
- 6 Responsibility for the insurance (or indemnity in lieu of insurance) of both inward and outward loans must be clearly specified in all loan agreements.
- 7 Loans cannot be made from collections that are not accessioned
- 8 Loans are not made for commercial purposes

Suggestions for Loan Procedure

- 1 The decision to borrow or lend an object/collection is based on the policy as defined in the written Collections Management Policy of the curatorial facility.
- 2 A complete loan record includes:
 - a a loan number for tracking purposes
 - b a start date for the loan
 - c an end date for the loan
 - d the purpose of loan
 - e the detailed inventory of loaned objects
 - f insurance value of loan
 - g agreed method of shipment
 - h approval of loan by an authorised person, persons or bodies (e.g. Director, Board, Government Export Licensing body)
 - i any special conditions, such as exhibit requirements, special handling or packing instructions
- 3 Loan due dates are tracked and extended, recalled or returned as appropriate at the end of the loan period.

The report should include the object's accession or catalogue number, composition, type, location, and extent of damage, previous repairs, name of examiner and date of examination.

Documentation

Documentation is a crucial part of collections management overall but is dealt with in a special chapter,

which includes detailed advice on documentation policy and procedures.

Preservation of collections

Collections Storage

Collections storage refers to the physical space where collections are housed when not on exhibition or being researched. The term is also used to describe the various kinds of furniture, equipment, methods and materials that are used in the spaces used for the museum's storage and study collections. Many collections spend the major part of their time in storage. Collection storage areas protect objects against harmful factors in the environment, accidents, disasters, and theft, and preserve them for the future. For these reasons, collections storage is not dead space where nothing happens, but is space where preservation of collections actively occurs.

The museum building provides the first layer of protection between the outside environment and the collections. Collections storage areas should be located internally within the building and away from external walls if possible, to minimize environmental fluctuation. Collections storage should be separate from all other activities, and only collections storage should happen within its walls so that its physical environment can best be controlled. It should have low light levels, stable temperature and relative humidity, and be free from atmospheric pollutants and pests. Physical access should be restricted to collections personnel so that it is kept secure, and fire protection should be installed.

Since the collections typically spend so much of their time in storage, it is necessary for all furniture and packaging materials that come into contact with them to be stable and non-reactive. Archival quality storage furniture includes cabinets and shelves made from

powder-coated steel or baked enamel steel. Small, stable objects are wrapped, bagged, or boxed before being placed in storage to provide a protective buffer between the object and the environment. Objects that cannot be wrapped due to their size or fragile composition preferably are stored in enclosed cabinets or shelves. Space is allowed between objects to allow for handling for retrieval. Do not crowd or overload shelves and drawers, as this will make it difficult to retrieve objects safely.

There are many different kinds of stable, archival materials that protect objects and not cause them to deteriorate. These materials usually cost more than ordinary boxes and papers, but the protective benefits they provide outweigh the additional costs. Recommended storage materials include: acid-free, lignin-free tags, labels, papers, folders, envelopes, boards, boxes, and tubes that are calcium carbonate buffered cotton, linen, and polyester fabrics, tapes, cords, and threads; polyester batting and films; polyethylene and polypropylene bags, microfoam boxes, and boards; cellulose adhesive; polyvinyl acetate and acetone adhesive; and glass jars and vials with polypropylene or polyethylene caps. A wide range of patented synthetic materials is widely used in museum storage, such as Tyvek™, Mylar™, and Marvelseal™. Within the broad range of materials available, something suitable can be found to store every type of museum collections. Many of the materials can be used to custom design and construct special boxes, trays, files, supports and mounts to support and protect particular specimens or works of art.

It is however important to avoid materials that are chemically unstable and which may therefore interact chemically with the objects they are in contact with and cause damage. These include wood and wood products, particularly acidic paper and cardboard, cellophane and masking tapes, adhesive tapes, foam rubber and urethane



Protective storage: fragile objects individually supported on padded shelves in enclosed cabinet.

foam, most plastics, nail polish, metal paper clips and staples, rubber bands and rubber-based glues. If unstable materials such as wood shelving have to be used, a stable barrier material such as acid-free board can be placed between the shelf and the objects.



Moving collections: fragile collections are safely moved in individual supports on a padded cart

Handling and moving collections

Collections are at increased risk of damage while they are being handled and moved. However, there has to be a balance between protection and preservation since it would be very hard to study, exhibit or otherwise use

museum specimens and collections if they cannot be handled at all. To prevent damage it is essential to be very careful and use common sense when handling objects of any size and type. Some very simple precautions can much reduce this risk. All objects should be handled as if they are the most valuable, and hands must be clean or protected by clean cotton or nitrile gloves. When moving items, determine where an object will be put down before it is picked up, and plan the route to be taken ahead of time to be sure it is free from obstructions. Carry one object at a time, or place objects on a padded tray or cart if many need to be moved over any distance. Allow plenty of time and get help if the object is too large or heavy to be easily moved by one person. Never risk your own safety, or the safety of the object.

Photography

Photography is an integral and specialized part of the documentation of museum collections. A photograph is not only a visual record of an object but also aids in research, education, and retrieval of an object if it is misplaced and as evidence in support of an insurance claim if something is lost or stolen. A photograph also documents the condition of an object at a particular point in time so that future comparisons can be made. For this reason high quality photography is essential. Though large format photographs (6cm x 6cm negatives or larger) used to be the museum standard, and many older museums have large archives of both glass plate and film negatives of their collections, with the great improvements in both lenses and film over the past 20 or 30 years nowadays 35mm black and white photography is the preferred medium for documentation purposes. Black and white film is much more stable over the long-term than colour film, can be used with a wide range of special filters which can enhance key features of the object in the resulting photograph, and can be processed in house.

However, digital photography is increasing in popularity and decreasing in cost, and high quality photographs can now be printed very quickly on what are now extremely cheap inkjet colour printers. On the other hand the longevity of digital images for museum purposes has yet to be evaluated: certainly any digital images should be transferred immediately from the camera's memory to a computer hard disk, with regular back-ups onto an external medium outside the museum (e.g. a remote computer system or CD-ROMs security stored away from the museum). Whatever the format, the photographs produced must be cross-referenced with the object's accession number and be organized in such a way that they can be easily retrieved and associated with the object.

Objects should be photographed as part of the accessioning procedure. Two-dimensional framed objects should be photographed upright and can be placed on an easel or on padded blocks and propped against a wall if they are very large. The lens of the camera must be parallel to the face of the object, and the objects should fill as much of the viewfinder as possible. A two-dimensional object that does not have a rigid support should be laid flat with the camera positioned above it in order to take the photograph. This is most easily achieved with the use of a copy stand, but a tripod also can be used if it can be tilted against a table in such a way that the lens is parallel to the face of the object. Three-dimensional objects require a background with a smooth surface that contrasts with the object but does not distract from it. Small objects can be placed on a sturdy table, and large ones can be placed on the floor on a clean, padded surface. It may be necessary to take several photographs from different angles in order to completely record an asymmetrical object. Special lighting may also be necessary, and if so, lights should be placed where they best show the shape, texture, and contours of the object.

Insurance

Insurance of collections is generally regarded as an integral part of risk management, which is a term used to describe the process of reducing the likelihood of damage or loss of collections by eliminating or at least minimising hazards. Insurance is not a substitute for poor collections management and security, and unique objects and collections are irreplaceable, but it can provide some monetary compensation in the unhappy event of damage or loss of objects and collections. Where insurance is permitted (see below), the aim of the insurance that is purchased is to provide sufficient monetary compensation to repair or replace the collections in the event of their damage or loss. Insurance varies greatly in terms of what can be insured and against what risk, where and under what circumstances the insurance applies, and how claims are handled. Collections therefore need to be valued with respect to their replacement cost or other monetary value on a regular basis so that the museum has an up-to-date schedule of insurance values. (Under most insurance contracts if the collections are undervalued overall the insurer will only be liable to pay the equivalent percentage of any claim. For example, if the collections are insured by the museum for only 50% of their true market value the insurer would pay only half of any claim for loss or restoration of damage relating to perhaps a single object.) Insurance or other valuation records must be kept up to date and, of course, under secure conditions with limited access.

However, policy and practice in relation to the use of insurance differs greatly from country to country and indeed museum to museum within the same country. In most countries the policy seems to be that the collections of State-owned national museums are not insured, and it is common for a Government Indemnity to be offered in place of insurance to owners of both temporary and

long-term loans to national museums, and perhaps other public museums. Where the use of commercial insurance is permitted, the museum must evaluate its insurance requirements carefully. An independent specialist fine arts insurance agent (usually known as an “insurance broker”) is likely to be able determine the insurance best suited to the requirements and will obtain competitive quotations from a range of different insurance companies.

Conservation of the collections

Preventive conservation is the subject of another chapter, but it is vital to stress here that this is a very important aspect of collections management. It has to underlie every aspect of museum policy and operations and must be seen as the responsibility of every staff member on an ongoing basis. Also, collections must be monitored on a regular basis to determine when an object or collection needs the attention of a conservator.

Preparing for Disasters

Disaster preparedness and response are also very important parts of the overall collections management responsibilities, but this is discussed in detail in the Museum Security chapter.

It should however be stressed here that the aim should be to ensure that preparing prevents as far as possible emergency situations, whether due to natural disasters, civil emergencies such as fire, or the effects of armed conflict, but does not lead to the loss of or serious damage to the museum collections. Necessary preparedness measures include risk assessment, good planning and design of buildings, furniture, equipment and systems and effective routine building and systems inspections and preventive maintenance. Effective emergency preparedness should be based on a written plan that is tested and evaluated at least once a year, and which addresses measures to be taken before, during, and after any emergency.

Public access to collections

Security

Security is discussed in detail in the Museum Security chapter. However, physical access to collections is an element of security that needs to be addressed in the collections management policy.

Box 6: Security Issues to be covered in the Collections Management Policy

- 1 Physical access to the collections, even for staff, is restricted by locked, secured location and controlled entry
- 2 The collections staff responsible for a particular subject, collection or storage area will supervise access by both other staff and by visitors
- 3 Records of staff having key access are to be kept
- 4 Records to be kept of all visitors allowed into storage and other secure areas of the museum.
- 5 Research access is on the basis of the approved research design, and all visits are similarly recorded, appropriately at the end of the loan period.

Display and Exhibition Galleries and Rooms

There are several different types of museum exhibitions. They may be short or long-term exhibits of objects from the museums collections, exhibits containing objects on loan from other institutions, or travelling exhibits. Other than visiting or other temporary exhibitions they all contain items from the museum collections, so the approved collections management procedures apply to objects in the exhibition galleries in the same way as to objects in storage areas.

Transferring objects from the secure storage areas into the exhibition galleries exposes collections to a variety of additional threats. Security threats include theft, vandalism, and unauthorised handling, while common conservation threats include shock and vibration, harmful exhibit mounts and supports, atmospheric

pollutants, environmental fluctuation, light, pests, and other natural factors. The control of visible light, ultra violet light, temperature and relative humidity, and atmospheric pollutants to recommended safe levels (see the Conservation chapter) presents a particular problem. Large numbers of visitors will introduce body heat, humidity and pollution to the galleries, while lighting that is bright enough to enable the exhibits to be viewed comfortably may cause long-term damage to items that are particularly light-sensitive, such as textiles, costumes, watercolour paintings and drawings.

Good exhibit design and fabrication, security, and use of suitable materials also will contribute to a controlled environment and protection of collections. How to achieve a controlled environment is discussed in a later chapter.

Monitoring collections on exhibition

Exhibit galleries should be inspected on a regular basis for any evidence of damage to or loss of objects on exhibit. Environmental control is achieved in a variety of ways with a variety of mechanical and manual systems, so exhibit galleries must be monitored to ensure that environmental controls are operating effectively. How to monitor the environment is discussed in detail in a later chapter.

Suitable exhibit materials.

The materials that are safe to use in collections storage are also safe to use in exhibit fabrication and presentation. Many materials used in exhibit fabrication are not archival in composition but are commonly used due to their other desirable characteristics and low cost. In such situations, archival barrier materials can be used between the reactive material and the collections object.

Packing and shipping

As part of exhibit production sometimes it is necessary to pack and ship museum collections to other institutions. This activity is even more risky than handling and moving collections and so the decision to do this must be made

after very careful consideration. Packaging and shipping methods are chosen based on the individual requirements of the objects being shipped, and only stable objects should be shipped because of the increased risk of damage. Packaging materials protect the objects from all reasonably anticipated risks associated with a particular shipping method. Suitable packing materials are the same as those used for storage of collections. Although urethane foam is not archival, it often is used in packing objects because of its excellent cushioning properties. Clean cushioning material is used based on the individual needs of the objects but the packing materials that have direct contact with the objects should be archival.

The shipping method chosen should provide the best protection for the objects and shortest en route time. Common shipping methods for museum objects are by road and by air. Rail shipment is used less frequently due to the increased shock and vibration associated with this method. Shipping by sea sometimes is used for very large and stable objects, but transit time often is very lengthy and it can be difficult to provide long-term climate-control in a shipping container. Transportation companies that have experience with transporting museum collections can provide valuable assistance in planning to ship museum collections.

Suggestions for Shipping Policy

Objects are carefully evaluated for stability before they are shipped. Only those that are stable may be shipped.

Who has the authority to make the decision on shipping is identified.

Suggestions for Shipping Procedure

The shipping method is based on the needs of the object, the distance to be shipped, and projected en route time.

Packing materials to be used are based on the type of shipping method chosen and needs of the object.

Research of collections

Research

Research on museum collections and publication of the findings provides a particular type of access to the collections, and allows museums to address their education and interpretation mission. It makes specialized information available to various interested parties and provides the basis for exhibitions and educational programming. It is very important that all museum research is legal, ethical, in accordance with academic standards, and supports the mission of the museum.

Field Collecting

When museums undertake field collecting it must be done in accordance with all laws and treaties, and must adhere to accepted academic standards. It also must be considerate of local populations and their needs and wishes.

In-house Research

Research by museum staff should relate to the museum's mission and scope. The research should conform to accepted academic standards. Research by museum personnel must take place within the museum. Staff should not be permitted to remove collections objects, even temporarily, from the museum for any purposes.

Visiting Scholars

Museums should have written policies for security, access to, and handling of collections by visiting scholars and researchers. Museums should promote in-house use of their collections by visiting scholars and researchers while providing for the security, protection, and safe handling of those collections during the research.

Destructive Analysis

Sometimes destructive analysis techniques are required to further research investigations. These must be undertaken only after careful consideration. Submission of a research proposal to the museum for evaluation should be required. The museum does not give up title,

nor is the object deaccessioned, and unused portions of objects are returned to the museum. Information gained substitutes for the altered or destroyed object.

Suggestions for Research Policy

Scholarly research is vital to the museum's educational and public service mission. Therefore, staff of the museum is free to choose the subject of research, initiate and conduct the research, seek the necessary resources to conduct the research, and disseminate the results of the research in an appropriate manner.

All research supports the mission of the museum.

Personal Collecting

Museum staff members often have personal collections as a result of their own particular interest and activities. However, as the *ICOM Code of Ethics* makes clear, staff should not compete with their institutions over acquisition of objects or personally collect the same types of objects that their museum does, because it would be a conflict of interest for a staff member to use their own specialized knowledge for personal benefit and not for the benefit of their museum. Any permissible departure from this restriction must be discussed with the governing body of the museum.

Conclusion

Assembling collections is one of the primary functions of a museum, and the objects that comprise the collections become amongst the most important assets of the museum. Preservation, care, and management of the collections fulfil the public trust responsibilities of the museum, and thus help to achieve the museum's mission. Good collections management is one of the strategies by which preservation and care is achieved. Adopting and implementing the collections management policies and practice recommended in this chapter will provide a firm foundation for implementing all various other strategies for running a museum.

Inventories and Documentation

Andrew Roberts

Former Head of Information Resources, Museum of London

Introduction

Accurate and accessible documentation is an essential resource for collections management, research and public services. This chapter develops the concepts in the Collections Management chapter, by providing practical advice on documentation procedures, including accessioning, inventory control and cataloguing. It discusses manual and computer-based systems and Web access to information. The guidelines are based on well-established standards.

Acquisitions, long-term loans and accessioning

The accessioning process supports the incorporation of permanent acquisitions and long-term loans into the museum collection (see the Collections Management chapter) (Buck and Gilmore, 1998; Holm, 1998; International Council of Museums. International Committee for Documentation, 1993). This is a key stage in the overall documentation of the collection, recording the legal evidence for the ownership of the items in the collection and providing the starting point for the fuller cataloguing of individual items.

The museum should develop a framework where proposed acquisitions and long-term loans are referred to an internal committee for approval, rather than being accepted by an individual member of staff. When the museum becomes aware of an acquisition or loan, it should start to develop a file with information about the owner and the objects. This file should include a summary sheet, with entries about the source, an outline

of the objects, their significance to the museum, the proposed acquisition method (e.g. gift, purchase, excavation), how the proposal conforms to the museum's collecting policy, the recommendations of the curator and other specialist staff and the decision of the committee. The outline of the objects should include an authentication of their origin and an assessment of their condition. If possible, the museum should produce a photograph or digital image of the objects.

In the case of an acquisition, if this is approved, the owner should be asked to sign a formal legal transfer of ownership of the objects (a 'transfer of title'). The signed copy of this document should then be added to the file, as an essential confirmation of the legal status of the acquisition.

If the museum regularly receives groups of objects, it can be more efficient to treat the overall group as a single acquisition, rather than processing each item as an acquisition. This typically applies within archaeology, history and natural history collections. The overall acquisition then has one file and an overall group accession number. The individual objects within the group can be given separate object numbers, which are either subdivisions of the accession number or independent of the accession number.

If the museum is going to be the repository for all the finds from an excavation, it should discuss with the excavator the possibility of the museum and the excavator having a common numbering approach. It may be possible for the museum to assign an accession

Example of an accession register (reproduced from Holm, 1998, with the permission of the MDA).

Entry number
 Allows easy cross-reference to the original entry form if required.

On completion of each page, the person with overall responsibility for the collection should sign and date the page to certify it as a true record.

Received from
 The name and address of the previous owner (i.e. the donor, vendor, etc.).

Brief description
 This should include the object name and a short description which should be the minimum necessary to adequately identify each item. A detailed description can be noted on the catalogue record for the item. Where there are several items listed under a single accession number, each name and description can be prefixed with an item number (see Chapter 12).

Initial storage location
 Note where the item is to be stored after completion of the accession record. This entry should not be altered if the item is subsequently moved. A more dynamic system for coping with location changes should be available (see Chapter 10).

Page number
 Register pages should be numbered to make the removal or loss of a page easier to detect.

1998 Board - 24.10.1998

Accession number	Date received or accessioned	Method of receipt	Received from	Method of receipt
E0987	1998.129	20.10.1998	Mrs A. Brown 12 South Lane Tipton Ardwick	Gift
E0989	1998.128	20.10.1998	Mr A.W. Jones (donor) 103 Hill Road Newtown Ardwick	Request
	1998.129	24.10.1998	Newtown	Unrecorded
E0992	1998.130	26.10.1998	Mr J. White 22 March Street Ayrton Midshire	Gift

Item number	Brief description, classification and historical information	Initial storage location	Action taken
1	Box of porcelain S.C. An with under glaze on cotton. White porcelain Knot with floral decoration.	Domestic gallery	Accessed storage during visit by once and partial documentation 1 March 21.2.1998
2	Straw hat Blue and white striped being very poor condition	Domestic Comm. 122	Accessed by Comm. 122 19.3.1998 in 10050
	Box of 100 pens, size K Made by J. Smith New Bond Street, London	Domestic 122	
	Antique watch 3rd class return Ayrton on 11.1.1998 dated 11.1.1998	Domestic 122	with the found during re-organisation of class. An account re-organisation had
1	Box of water can (2 pint) Small steel on wood	Box 52	
2	Ceramic case with key Box case, white enamel dish, height 2.5 cm	Domestic Gift 3	
3	Box of 100 pens (2 pint) Not scratched About 1000 from the house of Mrs J. Marchant (donor's grandmother) 22 Hill Street Ayrton	Box 52	

Accession number
 Some museums allocate a single number to cover several items received together as a group, others give each item a separate accession number (see Chapter 12).

Date received or accessioned
 In the past, the date of entry was often entered here. In the case of new acquisitions, this date will be recorded on the entry form so it is better to use this column for the date of formal accessioning.

Method of receipt
 The way in which this accession was acquired (e.g. gift, purchase, bequest, transfer, exchange, etc.).

Historical information
 This should be kept to a minimum. A detailed history can be noted on the catalogue record for each item.

Explanatory notes
 If necessary, the 'action taken' column can be used for other annotations. These might arise out of retrospective documentation work, for example.

Action taken
 Record any significant subsequent actions such as loss, disposal, re-accounting as part of a retrospective documentation project, or major alterations to the appearance of the object.

number to the overall excavation, which is then used in the field recording system from the start of the excavation. This approach would enable the museum to avoid the need to renumber and mark the individual objects and would assist the incorporation of the collection and the excavation records into the museum. It will not be feasible in cases where some of the finds from the excavation are retained by the excavator or passed to a number of museums, where there will need to be two numbering sequences.

In addition to the accession files, the museum should maintain an accession register, with a checklist of all the acquisitions. The register should ideally be a hardback volume, with archival quality paper. It should have columns for accession number, date, source, method, brief description of the group, number of objects making up the group and the name or initials of the museum curator. This should be kept in a secure location, such as a fire-proof safe. If possible, keep a copy of the register at another location.

In the case of a long-term loan, the museum should also record the reason for the loan and the duration of the agreement. Many museums are reluctant to accept long-term loans, unless the object is to be used in a gallery display or for extended research, because of the work involved in caring for objects. If the loan is approved, it should be finalised in a written loan agreement, which should then be kept on file. The loan should be added to a separate loan number sequence.

Exercise: use the accessioning guidelines as the basis for the design of an accession summary sheet, transfer of title form and accession register.

Inventory control and cataloguing

The second stage in the museum's documentation system is the development and use of information about the individual objects in the collection. The museum should aim to establish records about each of the items in the collection and continue to extend these records as the objects are examined and used. The records can be used as the basis for research, public access, display, education, collection development, collections management and security.

In order to support this range of uses, the records need to be consistently structured into discrete categories or fields, each of which can hold a specific piece of information. Table 1 summarises the recommended catalogue fields, details of which are given in the Appendix. It is recommended that the museum adapts the guidelines in this chapter as the basis for an internal inventory control and cataloguing handbook, with decisions on the fields to be used by the museum.

The inventory and catalogue fields in Table 1 are based on ideas developed by five existing projects, which have been applied by many museums around the world. The overall approach is based on the AFRICOM Handbook of Standards, developed by ICOM and the AFRICOM Co-ordinating Committee for use by museums throughout Africa. This includes over 50 fields, organised into four main groups (object management, object description, history of the object and documentation of the object) (column 3 in the table). The Handbook has been published in English-French and Arabic editions (International Council of Museums, 1996 and 1997) and has been used as the basis for training materials.

The AFRICOM standard was closely based on a set of more general guidelines developed by ICOM's International Committee for Documentation (CIDOC)

(International Council of Museums. International Committee for Documentation, 1995) (column 4). The third general model is the SPECTRUM standard, developed by the United Kingdom-based Museum Documentation Association (MDA). The full SPECTRUM standard is a substantial publication (Museum Documentation Association, 1997; Ashby, McKenna and Stiff, 2001), but the MDA has also issued a cataloguing manual, which incorporates the main fields (Holm, 2002) (column 5). The fourth standard is Object ID, which was developed as a specific guide to the information that is most helpful in the event of an object being stolen (see the Illicit Traffic chapter) (Thornes, 1999) (column 6). The final standard is Dublin Core (DC), which has been developed as a means of retrieving information resources on the Internet (Dublin Core, 2004) (column 7).

The published versions of these five standards can be consulted for more detailed information. The full text of the English-French edition of the AFRICOM Handbook and the CIDOC and Object ID standards can be accessed on the Web (see the references).

Inventory and catalogue fields

The fields in Table 1 are appropriate to the main subject areas in museums with archaeology, antiquities, ethnology, fine and decorative art, costume, history and natural history collections. Irrespective of the subject area, all records should include a number of core concepts, such as Object Number and Object Name (column 2 in the table). Other fields are equally essential for individual subject areas, such as the Title field for Art collections, the Production Period/Date field for archaeology collections and the Classified Name field for natural history collections.

A number of these fields are particularly important for collections management and security purposes, such as

Object Number, Current Location and Distinguishing Features. Other fields are important for research and public access, such as Producer/Maker and Production Period/Date. The actual fields relevant to the museum will depend upon its subject areas and its emphasis between research and public uses.

The basic 'inventory' of the collection is made up of records incorporating the core fields and those that are essential for individual subject areas. (In the case of individual works of art and archaeology, the inventory fields are those in the Core and Object ID columns in Table 1 (see the Illicit Traffic chapter).) One approach is to develop an inventory and a separate fuller catalogue, but it is more efficient to think of these concepts as a single information resource, which serves each of the purposes outlined above. The development of inventory-level information is the highest priority. This should include a photograph or digital image of the object.

Syntax and terminology

In addition to using a standard set of fields, it is important that the museum adopts a consistent syntax and terminology for the entries in the fields. Syntax rules define the way the information in the field is structured. Terminology rules define the terms that are allowed in a field. The museum's decisions on syntax and terminology should also be incorporated in the internal cataloguing handbook.

One example of syntax control is the style used for recording personal and organisational names. Museum records are rich in names (collectors, producers, donors, conservators, etc.), and these can be made up of a number of elements, so it is important to follow a uniform approach. If the museum does not have an established rule for personal names, it may be useful to review the approach taken by major libraries in the country, comparable to the Anglo-American

Cataloguing Rules (AARC) which are widely used in English-speaking countries.

The standard approach for personal names written in the roman alphabet is to place the surname first, followed by a comma then the initials or forenames (e.g. 'Smith, John'). In contrast, organisational names should be written in the style used by the organisation and should not be inverted (e.g. 'H.J. Heinz Company Ltd').

For personal names in Arabic, the AARC guidelines advise that in the case of a personal name which contains a surname or an element comparable to a surname, the cataloguer should use this part of the name as the primary entry. In the case of a name that does not contain a surname or an element comparable to a surname, the cataloguer should use the element or combination of elements by which the person is best known as the primary entry. The primary entry should then be placed at the beginning of the name, followed by other elements (e.g. 'Mālik ibn Anas'). Include a comma after the primary entry, unless it is the first part of the name (e.g. 'Sadr al-Dīn al-Qūnawī, Muhammad ibn Ishāq').

Another example of syntax control is dates, where the AFRICOM standard uses the style 'year/month/day' ('YYYY/MM/DD') (e.g. '2004/08/24'). A third example is the sequence of concepts making up the definition of a production place or collection place, where the preferred order is specific to general (e.g. 'Eiffel Tower, Champ de Mars, Paris, France').

It may be necessary to include two or more distinct entries in an individual field, such as the names of two producers involved in different stages of producing an object or the multiple materials making up a complex object. The museum should adopt a consistent approach to the way these entries are separated from each other, such as the use of a semicolon between multiple entries (e.g. 'gold; silver').

The AFRICOM standard also includes useful examples of terminology for individual fields in both the English-French and Arabic editions (International Council of Museums, 1996 and 1997). These include lists for Material and Technique.

The description of the Acquisition method and Acquisition date fields, taken from the appendix

Acquisition method (core field)

The method by which the object was acquired.

Examples: 'excavation', 'gift', 'purchase', 'unknown'

The AFRICOM handbook (field 1.5) has a term list.

Acquisition date (core field)

The date the object was acquired.

Examples: '2004/08/24'

Exercise: use the inventory and cataloguing guidelines as the basis for an internal inventory control and cataloguing handbook, with decisions on the fields and the syntax and terminology controls to be used by the museum.

Object numbering, labelling and marking

It is important to assign a unique number to each object and to relate this to the object by either writing it on a label associated with the object or marking it on the object itself (International Council of Museums. International Committee for Documentation, 1994). The object number provides the link between the object and its documentation and can be invaluable if the object is stolen or misplaced.

Example of a term list for materials (reproduced from International Council of Museums, 1996, with the permission of ICOM).

MATERIAL OF ANIMAL ORIGIN / MATÉRIAUX D'ORIGINE ANIMALE	Metal / Métaux :
animal amber / ambre	aluminum / aluminium
animale	copper (and alloys) / cuivre (et alliages)
bone / os	gold / or
coral / corail	iron (and alloys) / fer (et alliages)
egg shell / coquille	lead / plomb
feather / plume	non identified metal / métal non identifié
gut / boyaux	silver / argent
hair / poils (et cheveux, crin...)	tin / étain
horn / corne	zinc / zinc
ivory / ivoire	Stones / Pierres :
mother of pearl / nacre	alabaster / albâtre
leather (tanned) / cuir (tanné)	flint / silex
pearl / perle	granite / granit
scale / écaille	gypsum / gypse
sea shell / coquillage	lapidolite / lapidolite
silk / soie	lava / lave
sinew / nerf (tendon...)	limestone / calcaire
skin (not tanned) / peau (non tannée)	marble / marbre
tooth / dent	sandstone / grès
tortoise shell / carapace	schist / schiste
wax / cire	serpentine / serpentine
wool / laine	slate / ardoise
MATERIAL OF VEGETABLE ORIGIN / MATÉRIAUX D'ORIGINE VÉGÉTALE	soap-stone / stéatite
amber / ambre	stone (not precious and unidentified) / pierre (non précieuse et non identifiée)
bamboo / bambou	Precious and semi- precious stones / Pierres précieuses et semi précieuses
bark / écorce	agate / agathe
calebash / calebasse	amethyst / améthyste
corn / maïs	aragonite / aragonite
cotton / coton	cornelian / cornaline
dung / fumier	diamond / diamant
flower / fleur	emerald / émeraude
fruit / fruit	hematite / hématite
grass / herbe	jasper / jaspe
leaf / feuille	malachite / malachite
millet / mil	obsidian / obsidienne
nut / noix	precious stone (unidentified) / pierre précieuse (non identifiée)
paper / papier	quartz / quartz
peanut / arachide	ruby / rubis
root / racine	sapphire / saphir
raphia / raphia	tourmaline / tourmaline
reed / roseau	Processed material / Matériaux élaborés
resin / résine	cement / ciment
rubber / caoutchouc	clay / argile
rush / jonc	glass / verre
seeds / graine	plaster / plâtre
straw / paille	synthetic material / matériaux synthétique
thorn / épine	
vegetal fibers / fibre végétale	
wood / bois	
MATERIAL OF INORGANIC ORIGIN / MATÉRIAUX D'ORIGINE MINÉRALE	

If the museum follows the approach of using group accession numbers, the object number may be a subset of the group number or independent of the group number. If the museum follows the approach of giving each object a unique accession number, the object number will be the same as the accession number. The number must be unique within the museum: if similar numbers are used by two or more departments or within two or more collections, prefix each number with a code to make the overall number unique.

In the case of an excavated object, the museum should decide whether it is possible to use the number assigned at the time of excavation, or whether to establish a separate object number. If it is possible to agree to a common numbering approach with the excavator, this can remove the need to renumber and mark the objects and aid the incorporation of the excavation records into the museum. If this is not the case, the original excavation number should be recorded within the museum record.

If the object is made up of two or more parts, it is important to label or mark each part, in case they become separated, such as on display or during conservation. The parts can be given separate part numbers, formed by subdividing the object number (e.g. by adding letter suffixes).

See the Collections Management chapter for guidelines on labelling and marking.

Location and movement control

It is essential that all changes of storage location are carefully tracked. This enables the museum to quickly find an object and helps reduce the chance of objects being misplaced or being stolen without the museum being aware of the loss.

The recommended catalogue fields include separate

Table 1. Recommended catalogue fields and correlation with other guidelines

Field	Core	AFRICOM	CIDOC	MDA	Object ID	Dublin Core
Object Management						
Museum name	x	1.3	x	x		x
Object number	x	1.4	x	x		x
Accession number	x					
Acquisition method	x	1.5	x	x		
Acquisition date	x	1.6	x	x		
Acquisition source	x	1.7	x	x		
Normal location	x	1.8	x	x		
Current location	x		x	x		
Current location date	x		x	x		
Current location reason						
Remover						
Conservation method				x		
Conservation date				x		
Conservator				x		
Conservation reference number				x		
Deaccession/disposal method			x			
Disposal date			x			
Disposal recipient			x			
Object description						
Physical description		2.17	x	x		x
Distinguishing features		2.17			x	
Image reference number		2.1	x	x	x	
Object name/common name	x	2.9/2.10	x	x	x	x
Local name		2.11/2.12				
Title		2.13	x	x	x	x
Classified name		2.8	x	x		x
Category by form or function		2.2			x	
Category by technique		2.3				
Material	x	2.14	x		x	
Technique		2.15	x	x	x	
Dimensions	x	2.16	x	x		

Table 1. continued

Field	Core	AFRICOM	CIDOC	MDA	Object ID	Dublin Core
Specimen form		2.4				
Body part		2.5				
Sex		2.6				
Age or phase		2.7				
Content/subject		2.18	x	x	x	
Inscription/mark type			x			
Inscription method			x			
Inscription position			x			
Inscription transcription			x			
Inscription translation			x			
Inscription description		2.19	x		x	
Condition assessment		2.20	x			
Condition date			x			
History						
Historical comments		3.26				
Producer/maker		3.1/3.3	x	x	x	x
Production place		3.2	x	x		x
Production period/date		3.4/3.5	x	x	x	
User		3.8	x	x		
Place of use		3.9	x	x		x
Period/date of use		3.11	x	x		
Collection or excavation place		3.12	x	x		
Site reference/name		3.15		x		
Site co-ordinates		3.13				
Object co-ordinates		3.14				
Site type		3.16				
Age/period of feature		3.17/3.18				
Collector/excavator		3.21/3.22	x	x		
Collection/excavation date		3.23	x	x		
Collection/excavation method		3.24	x			
Collection/excavation number		3.25		x		
Documentation						
Publication reference		4	x	x		x

entries for Normal location and Current location. The Normal location is the long-term location of the object, such as a storage area or gallery, while the Current location is where the object is currently held, such as in a conservation area or on loan to another museum. The current location should be updated each time the object is moved, together with the date, the reason and the responsible person.

The museum must take special care to ensure that the information about the location of a particular object or collection is kept secure. This information can be of great assistance to criminals considering raiding the museum.

Conservation information and condition reports

If the object is conserved, a reference to the conservation work should be incorporated in the catalogue record. If there are fuller details about the process, it may be most efficient to hold these in a separate file, linked to the catalogue record via a Conservation Reference Number.

Similarly, if a condition report is produced about the object, note the condition status and date in the catalogue record and keep a full condition report on file (see the Collections Management chapter).

Images produced during conservation work and when preparing condition reports should be retained by the museum. These can be linked to the object record.

Deaccessioning and disposal

If the object is removed from the collection, it is essential that information about the removal is added to the catalogue record. The overall catalogue record should be retained, so that the museum has evidence of the fate of the object.

As with a new acquisition, the proposed de-acquisition should be referred to an internal committee for approval (see the Collections Management chapter).

Backlog accessioning, inventory control and cataloguing

Unless the museum is newly established, the staff are likely to be responsible for existing collections with incomplete records and problems such as difficulties in finding individual objects and relating these to the existing records. In addition to introducing new procedures, it may be necessary to carry out a backlog documentation project to bring the existing documentation and organisation of the collection up to the required standard.

The starting point for the backlog project should be a review of the history and scope of the collection (Ashby, McKenna and Stiff, 2001). This review should include a description of the main groups within the museum, including individual collections and major acquisitions. It should also describe the available information, such as the extent of accession and catalogue records and files, the depth of information, the use of manual and computer approaches, etc.

If there are major gaps in the records and files, it will probably be necessary to develop new or improved catalogue records. The priority should be to establish records which cover the whole collection, concentrating on the inventory fields. Fuller details can then be added as time and staff expertise allow and as the collection is used by staff and researchers. If the museum needs to carry out this work for a substantial part of the collection, this may be an ideal time to introduce a computer-based application and to create images of the collection (see below).

The backlog work will probably need to include physical checks of the collections in the stores and on display and a check of the details in existing registers and records, plus a reconciliation between the two sets of information (Holm, 1998). This can be a time-

consuming exercise in a museum with a substantial collection, but is an essential step in bringing the collection under control.

The stores-based work should consist of a systematic check of each object in the store and the development of a record about the object. If the object does not have a legible Object Number, it may be possible to trace this using the available documentation, or it may be necessary to assign a temporary number, in the hope that this will be superseded by the correct number at a later stage in the project. It is essential that the temporary number is associated with the object, using a label.

In addition to the Object Number, the record should include basic descriptive details (e.g. object name, classified name or category, title, material and dimensions) and the current storage location. If possible in the time available, add a brief physical description and note any distinguishing features, inscriptions or marks and the condition of the object. In addition, take one or more images of the object, for internal reference and as a resource for researchers and public access.

It can be very time consuming to record even this basic set of concepts and the museum will need to be realistic about the scale of the work and what is achievable with the available resources. It may be more important to have limited details across the collection than to record information in each of these fields. It will be desirable to carry out a pilot project to test the timings and work out the best methodology. It is particularly important to establish the most efficient work flow for the imaging work, including possibly establishing a basic studio facility in the store.

If the museum does have existing records, these can be used as the second source for the backlog project. For example, if there are old registers or catalogue cards, the details can be used to establish a complete run of records

corresponding to all the object numbers, whether or not the objects have being traced. Once the physical checks have been completed, it should be possible to identify records where the objects have not been traced and to then annotate these records to show the current status of the objects. The records should be retained in the system, for future reference and in the hope that the objects may be identified at a later date.

In addition to the catalogue records, it may be necessary to establish new accession files. If the museum is not sure whether individual collections are acquisitions or long-term loans or the duration of loans, it may be necessary to contact the original source for clarification. This can be a sensitive issue, as it carries the risk that some sources may ask for the return of the objects, but it is a necessary step in validating the status of the collection.

Exercise: produce a report outlining the history of the collection and the availability of information about the collection.

Exercise: develop a plan for the backlog cataloguing of a specific collection.

Manual and computer-based cataloguing and retrieval

The catalogue information can either be recorded in a manual system or a computer-based system. The preferred approach depends on the museum's expertise and resources.

The most effective approach in a manual system is to design record cards or sheets, with spaces for the

different fields listed in Table 1. The master copies of these records can then be stored in Object Number order, as the primary authority about the collection. If the museum has a number of different subject areas, it may be useful to produce separate designs for each of the main areas. For example, a record card for archaeology can give an emphasis to collection fields, while a card for art can give an emphasis to production fields.

If resources allow, the museum should produce a duplicate copy of these records and store this at another location, such as an overseas museum (see the *Illicit Traffic* chapter). The museum should also maintain indexes to the most useful and frequently consulted information, such as Current Location, Object Name, Producer, Production Period/Date and Collection Place.

A computer cataloguing system stores information and images about the objects in the collection in a more flexible format than a manual system (Holm, 1998; Holm, 2002; International Council of Museums, 1996). The computer system should include an underlying database, data entry and search screens, facilities to produce printed reports and transfer information to other systems and procedures for backing up the database. The system should support efficient cataloguing and a wide range of searches. It should also enable the museum to store secure copies of its records at external sites.

One option is for the computer system to take the place of manual records, with information being recorded directly onto the database. An alternative option is for the system to be used in association with manual records, with these providing the basis for the information entered onto the database.

In addition to cataloguing functions, the scope of a computer system could be extended to support a range of collections management functions, such as

accessioning, exhibition development, location control and conservation management. The museum could also consider providing the public and researchers with on-line access to information, both within the museum and on the Web.

The key step in introducing a computer application should be a functional analysis of the requirements of the museum. This can build on the review of the history and scope of the collection, summarising the current state of information and the museum's plans for developing this situation. It should describe the potential number of records and the depth of information to be incorporated in the system, the potential number of images, the scale of any backlog work, the priority on cataloguing, collections management and public access and the potential number of users (staff, public and researchers). These details provide the museum's management with the evidence for deciding how to proceed in introducing the computer application.

Following the work on the functional analysis, the museum may decide to develop a new computer application, using its own skills or those of a software agency to adapt a general-purpose database management system. An alternative approach is to acquire one of the externally-developed applications used by a number of other museums, such as those listed by the MDA, the Museum Computer Network and other advisory bodies (see the Sources). The more substantial museum applications include a number of modules, which support cataloguing, collections management and public access. If the museum decides to investigate these externally-developed applications, the functional analysis can be used as the basis for a statement of requirements (a Request for Proposals). This can be issued to the potential vendors and form the structure for their proposals, which can be evaluated by the museum.

Simple object name dish		Number of items 1	Institution : Identify number ANYTM : 1989.57
Other object name		Classification : catering equipment & tableware : pictorial, ornaments, etc. & trays and dishes ; 2.664	
Title			Serial number
Brief summary Small Aynsley ware dish (10.9 cm in diameter) with transfer printed fruit design signed 'D. Jones'. Maker's mark and pattern number 1325 1 on the underside.			
Maker/creator manufacturer : Aynsley, John and Sons Ltd ; designer : Jones, D.			Date made 1960 == 1960
Where made Longton (Portland Works) & Stoke on Trent & Staffordshire & UK			Method
Associated people owner : Fairhurst, Helen, Mrs			Date associated 1960==1990
Associated places Jasmine Terrace & Joyville & Midshire & UK			
How acquired gift	Acquired from Fairhurst, Sarah Louise, Mrs (14 Glenesk Road, Joyville, Midshire)		Date acquired 1.5.1989
Entry form number E 1074	Home location : Date crazz : 1.5.1989	Current location : Date dec arts case 4 : 22.8.1989	SIMPLE CARD © 1988

Physical description (e.g. materials, colour, shape, inscriptions, etc.) Bone china, small circular dish, cream ground with transfer printed fruit decoration (apple, blackberries, plums, hazel nuts) signed 'D. Jones'. Maker's mark and pattern number 1325 / 1 on the underside.			
Size (l : b : h) dia 10.9 cm	Complete <input checked="" type="radio"/> Y / <input type="radio"/> N / ?	Condition very good: 1.5.1989	
Conservation method	By whom conserved	Date conserved	Ref. No.
Notes, cross references, etc. Formerly belonged to the donor's mother, Mrs Helen Fairhurst photo ref. : P326-P329 (b/w print)		Drawing or Photo 	
SAH : 1.5.1989			

Example of a catalogue card (reproduced from Holm, 2002, with the permission of the MDA).

Classification (pictures, ornaments, etc. - tops and dishes)

Classification 2.664

Classification 2.46

British Museum Cataloguing System

Identify number: ANY (M 1302.5) Assigned to: Previous no.: New count: 1 Pict count:

Ident/Location
 Object name: Dish
 Object type:
 Object form: eating equipment - tableware
 Title:
 Summary: Small Apricot ware dish (18.3 cm in diameter) with transfer printed fruit design signed 'D. James'. Maker's mark and pattern number 1325 / 1 on the underside.

Production
 Designer: Title: Designer / initials: Designer: James
 Body: Form: material/texture: Name: Aptley, John and Sons Ltd
 Place: Street: Longton (Parfled) Wro. Field: Stoke on Trent County: Staffordshire County: England
 Date: Start: 1954 End: 1961 Period: Modern

Acquisition
 Person: File: Name: Title: Mrs. Fairhead Designer / initials: Designer: Helen
 Body: File: Name:
 Place: Street: Jamaica Terrace Field: Jopwell County: Middlesbrough County: England
 Date: Start: 1962 (local) End: 1965 Period: Even

Acquisition
 Person: File: Name: Title: Mr. Fairhead Designer / initials: Designer: Sarah Louise
 Body: File: Name:
 Address: 14 Glenwood Road, Jopwell, Middlesbrough Middlesbrough Date: 1.9.1965 Day: 1874

Location
 Material: Location: none Date in: 1.9.1969 Date out: Reason:
 Current: Location: 5th into case 4 Date in: 22.8.1993 Date out: Reason: display

Physical description
 Description: Bone china, small circular dish, cream ground with transfer printed fruit decoration (apple, blackberries, pears, hazel nuts) signed 'D. James'. Maker's mark and pattern number 1325 / 1 on the underside.

Size: Part: whole Dimension: diameter Reading: 18.3 Unit: cm Completeness: complete
 Condition: good State: total Date: 1.9.1965 Accession: SAH

References
 Author: Date: Title: Journal / Publisher: Vol: Issue:

Images
 Reference no.: 1302.51a.jpg Type: digitized image Photographer: SAH

Valuation
 Value £: Value: Date: Admin category:

Conservation
 Method: Conservation: Date: Ref. No.:

Revised created / edited
 Records: SAH Date: 1.9.1969 Role:

Notes
 Formerly belonged to the donor's mother, Mrs Helen Fairhead.

Reference no.: 1325-1328 Date: none (to be) Photographer: none

Example of a computer data entry screen (reproduced from Holm, 2002, with the permission of the MDA).

Images

Photographic images, digital images and scientific drawings of the collection are a valuable resource, both for internal reference purposes and for use by researchers and the public. For example, they can be shown to law officers and customs officials and the media if an object is stolen (see the *Illicit Traffic* chapter) and they can be added to the Web if the collection is put on-line. Ideally, it is useful to have an overall image of the object, plus one or more detailed images of distinguishing features and inscriptions.

Digital images are the most flexible resource, if the museum has access to digital cameras and scanners and staff with the skills to produce good quality images. The recommended approach is to take an archival image and use this as the source for thumbnail and full-screen size derivative images. The archival image can be saved to off-line storage, while the smaller derivative files can be stored on-line. The preferred image format for archival images is TIFF and for reference images is JPEG.

If the museum has existing conventional photographs, it may be efficient to produce digital copies of these to use alongside images produced directly by digitisation. If a third party has images of the museum collection, such as in an excavation report or a publication, these may also be potential sources. As noted above, a backlog project is an ideal opportunity to produce a consistent set of digital images. It is also important to build imaging work into day-to-day accessioning and cataloguing.

If the museum is using a computer-based cataloguing system, it should be possible to link the derivative images to the records, so that the thumbnail image displays as part of the catalogue record. The Image Reference Number provides the link between the image and the catalogue record.



Examples of catalogue record and reference image within a Web catalogue application: Museum of London Ceramics and Glass collection, record A27744, www.museumoflondon.org.uk/ceramics (reproduced with the permission of the Museum of London).

Web access to the information about the collection

If the museum is developing computer-based records and digital images, this gives it the potential to provide access to information about its collections on the Web. Depending on the technical facilities and expertise available to this museum, this can be accomplished by providing on-line access to a public access module in the museum's cataloguing system or by copying information from the internal system into a specific Web application. The technical requirements can be assessed in parallel with the review of the computer system.

A key issue in considering a Web development is to identify the potential users and match the Web resource to their interest. The museum will need to consider whether its priority is on supporting researchers, the general public or education groups. The main interest of researchers is likely to be the flexibility to search and browse through detailed catalogue records and images. The public and



Examples of Web catalogue application: Museum of London Ceramics and Glass collection, www.museumoflondon.org.uk/ceramics (reproduced with the permission of the Museum of London).

education users may be more inspired by a combination of contextual information, images and basic catalogue information, such as the history of the collection and the ability to browse through its major themes.

If the museum does decide to develop a Web-based catalogue, it may be worth discussing with other museums the potential for a shared approach, such as a collaborative Web site and a national catalogue.

Staff and financial resources

One of the greatest costs associated with documentation is the work involved in developing records and particularly carrying out backlog cataloguing. In addition to the input by core staff, this type of work is very suitable for temporary project staff and volunteers, who can build up valuable skills.

The second major budget issue is the cost of a computer system, including hardware and a cataloguing

Exercise: carry out a review of other Web sites developed by museums with similar interests and collections and also assess the needs of users, to identify what information would be useful on the Web and whether this influences the approach to cataloguing and imaging. In the case of Iraqi museums, see <http://icom.museum/iraq.html> for ideas about relevant museums.

application, imaging facilities and potentially Web access services, and the regular replacement or updating of all of these. It will also be necessary to have a budget for consumables, including registers, forms and catalogue cards or sheets if using a manual system.

Sources and references

A number of international and national organisations have developed documentation principles over the last 30 years. These can be consulted for additional advice and support.

The leading international body is the International Committee for Documentation of the International Council of Museums (ICOM-CIDOC). CIDOC can be contacted through ICOM, or see the CIDOC Web site for general information (<http://www.cidoc.icom.org/>). The United Kingdom-based MDA (Museum Documentation Association) is one of the longest-established national organisations. The MDA Web site has general information (<http://www.mda.org.uk/>), including copies of an extensive set of Fact Sheets (<http://www.mda.org.uk/facts.htm>). Another long-established organisation is the US-based Museum Computer Network (MCN), with extensive advice for members (<http://www.mcn.edu/>).

Appendix. Recommended catalogue fields

Object management

Object identification

Museum name (core field)

The museum name, including the name itself and the

town or city in which the museum is based.

Examples: Arab Museum, Baghdad

Object number (core field)

The number for the object, assigned by the museum and marked on or attached to the object. If the museum follows the approach of using group accession numbers, this object number may be a subset of the group number or independent of the group number. If the museum follows the approach of giving each object a unique accession number, this object number should be the same as the accession number. The object number must be unique within the museum: if similar numbers are used by two or more departments or within two or more collections, prefix each number with a code to make the overall number unique.

Examples: IM 012345,1

In the case of an excavated object, the museum should decide whether it is possible to use the number assigned at the time of excavation (Collection/excavation number), or whether to establish a separate object number. If it is possible to agree to a common numbering approach with the excavator, this can remove the need to renumber and mark the objects and should aid the incorporation of the collection and the excavation records into the museum. If this is not the case, the original excavation number should be recorded within the museum record.

Acquisition information

Details about the acquisition of the object by the museum, documenting the legal status of the object within the collection. This information should be recorded when the object is acquired and then incorporated in the catalogue record.

Accession number

The overall accession number of the group of which the object is a component, if the museum follows the approach of using group numbers. If the Object number

is a subset of the group number, this accession number should be implicit in the Object number.

Examples:

Acquisition method (core field)

The method by which the object was acquired.

Examples: 'excavation', 'gift', 'purchase', 'unknown'

The AFRICOM handbook (field 1.5) has a term list.

Acquisition date (core field)

The date the object was acquired.

Examples: '2004/08/24'

Acquisition source (core field)

The name of the person, group or organisation from whom the object was acquired.

Examples:

Storage information

Details about the location of the object in the museum or at an external venue.

Normal location (core field)

The normal location of the object, such as a storage area or gallery. Include specific information, so that the object can be easily located. Update this information if the object is moved to a new long-term location.

Examples:

Current location (core field)

The current location of the object, as a means of tracking the object when it is moved from its permanent location, such as being held for conservation or sent on loan to another museum. Update this information and the date field each time the object is moved.

Examples:

Current location date (core field)

The date the object was moved to its current location. Update this information each time the object is moved.

Examples: '2004/08/24'

Current location reason

The reason the object was moved to its current location.

Update this information each time the object is moved.

Examples: 'conservation', 'loan'

Remover

The member of staff who moved the object to its current location. Update this information each time the object is moved.

Examples:

Conservation information

Information about conservation work on the object. Complete this information each time the object is conserved.

Conservation method

The primary method or treatment technique used during conservation work.

Examples: 'cleaned', 'repaired'

Conservation date

The date of the conservation work.

Examples: '2004/08/24'

Conservator

The person who carried out the conservation work.

Examples:

Conservation reference number

A link to fuller information about the conservation work, such as details about the methods used and the results of the work.

Examples:

Deaccession and disposal information

If the object is removed from the collection, record information about the removal. The overall record should then be retained, so that the museum has evidence of the fate of the object.

Deaccession/disposal method

The method by which the object is removed from the collection.

Examples: 'destruction', 'loss', 'transfer'

Disposal date

The date of the deaccessioning and removal of the object.

Examples: '2003/01/12'

Disposal recipient

The name of the organisation that has received the object, in cases where the object is transferred to another organisation.

Examples:

Object description

Overall descriptive assessment

Physical description

A brief general physical description, summarising the physical attributes of the object. This should be suitable for use in the event of loss and in a gallery or exhibition caption, a publication or an on-line system. If the object is made up of two or more parts, clarify this in the description. Do not include information about the condition of the object or evidence of damage, repairs or defects (see the Condition assessment and Distinguishing features fields)

Examples: 'Queen's lyre from Ur, southern Iraq, c. 2600-2400BC'

Distinguishing features

A specific note of any distinguishing characteristics of this object, which can be used to help identify it and distinguish it from other similar objects in the event of its theft. Include evidence of damage, repairs or defects, expanding on the condition information (see the Condition assessment field). Omit information about inscriptions and marks (see the separate Inscription fields). Work during the Object ID project established that this information is particularly useful to law officers, in combination with images of the object which show the features. Record the information in a non-technical style that can be readily interpreted by law officers.

Examples: 'Hairline cracks in bowl, repairs to base'

Photographs and digital images

Image reference number

Information about one of more photographs or digital

images, which can be used to identify the object and can be consulted by researchers and the public. The availability of an image is particularly valuable if the object is stolen and if the museum provides on-line access to the catalogue. If possible, incorporate versions of the image within the record itself. The image number may be comparable to the object number or in a separate series.

Classification and name information

Object name/common name (core field)

The common name of the object, likely to be familiar to a member of the public or researcher. It may be useful to include a general name, followed by a more specific technical name, so that the information is relevant to the general user and the researcher. In the case of an archaeology, art or history object, this entry may be supplemented by the two category fields (Category by form, function or type and Category by technique). In the case of a natural history specimen, this entry is for the non-Latin form of the name, while the Latin name is recorded in Classified name.

Examples: 'comet orchid', 'cuneiform tablet', 'cup', 'cylinder seal', 'lyre', 'stool'

Local name

The vernacular name of the object or the name in another language.

Examples:

Title

The title of the object or the name given to the object by its maker or by reference to its iconography.

Examples:

Classified name

The classified name of a natural history specimen.

Examples: 'angraecum sesquipedale'

Category by form, function or type

A classification term describing the physical form, function or type of the object. The specific approach will

depend on the subject area.

Examples: 'container', 'furniture'

The AFRICOM handbook (field 2.2) has a sample term list.

The Red List of Iraqi Antiquities at Risk includes a number of categories of objects (tablet, cone, seal, plaque, sculpture, container, jewellery, manuscript, architectural fragment, coin)

(<http://icom.museum/redlist/irak/en/index.html>)

Category by technique

A classification term describing the technique used to produce the object. The specific technique should be recorded in the Technique field. The use of this classification field will depend on the type of collection.

Examples: 'ceramic', 'basketry'

The AFRICOM handbook (field 2.3) has a sample term list.

Physical characteristics

Material (core field)

The materials of which the object is made. It may be necessary to record two or more terms.

Examples: 'gold', 'marble', 'clay'

The AFRICOM handbook (field 2.14) has a sample term list.

Technique

The technique or process used to create the object. It may be necessary to record two or more terms.

Examples: 'gilded', 'printed', 'woven'

The AFRICOM handbook (field 2.15) has a sample term list.

Dimensions (core field)

The dimensions of the object, including height, length, width and weight, as appropriate. Use mm and gm as the preferred units.

Examples:

Specimen form

The physical form of a natural history specimen.

Examples: 'egg', 'fossil'

Body part

The specific part of the body represented by a biological specimen.

Examples: 'cranium'

Sex

The sex of a specimen.

Examples: 'male', 'unknown'

Age or phase

The age or phase of evolution of a specimen.

Examples: 'adult'

Physical content/subject

Content/subject

The subject or iconography of the object, including the representation of abstract concepts, people, places and events. Do not include information about inscriptions and marks (see below).

Examples: 'representation of an animal'

Inscriptions and marks

Information about inscriptions and marks on the object. Build up separate details about each significant inscription on the object. As with Distinguishing features, this information can be useful in the event of a theft, but it is also a valuable resource for researchers, particularly when supported by an image.

Inscription/mark type

The type of inscription.

Examples: 'inscription', 'mark', 'signature', 'watermark'

Inscription method

The method used to produce the feature.

Examples: 'engraved', 'incised', 'stamped'

Inscription position

The position of the inscription on the object.

Examples: 'base'

Inscription transcription

A transcription of the source, in the original language.

Examples:

Inscription translation

A translation of the source.

Examples:

Inscription description

A description or interpretation of the inscription.

Examples:

Condition information

A summary of the condition of the object, including a condition assessment and date. Include a fuller description of the physical condition of the object in Distinguishing features. Complete this information each time the condition is assessed.

Condition assessment

An evaluation of the physical condition of the object.

Examples: 'fragile'

Condition date

The date of the condition assessment.

Examples: '2004/08/24'

Condition assessment

An evaluation of the physical condition of the object.

Examples: 'fragile'

Condition date

The date of the condition assessment.

Examples: '2004/08/24'

History

Historical comments

A brief history of the object, suitable for use in a gallery or exhibition caption, a publication or an on-line system.

Examples:

Production information

Producer/maker

The person, organisation or social or cultural group who produced the object. In the case of a complex object, it may be necessary to record two or more names and to qualify these with the role of the person, group or

organisation ('artist', 'engraver', 'designer', etc.).

Examples:

Production place

The place where the object was produced.

Examples: 'unknown'

Production period/date

The period or date of the production of the object. The museum should develop a term list for periods.

Examples: 'Uruk III', '600-300BC'

Use information

User

The person, organisation or social or cultural group who used or was associated with the object.

Examples:

Place of use

The place where the object was used or associated with the history of the object.

Examples:

Period/date of use

The period or date when the object was used.

Examples: '600BC'

Collection place and excavation information

Collection or excavation place (provenience)

The geographic description of the place where the object was found or excavated. This should include a hierarchy of terms defining the place, from specific to general.

Examples: 'Nimrud, Iraq'

Site reference/name

The reference name or code for the place within the museum system or a related archaeological system.

Examples:

Site co-ordinates

The geographical co-ordinates of the place.

Examples:

Object co-ordinates within the site

The relative co-ordinates of the object within the place.

Examples: SW37

Site type

The type of site, according to an established typology.

Examples:

Age/period of feature

The archaeological or geological age/period of the place.

Examples:

Collector/excavator

The collector or excavator of the object, including the name of an individual and any expedition.

Examples:

Collection/excavation date

The date the object was collected.

Examples: '1921'

Collection/excavation method

The collection method.

Examples: 'surface collection', 'excavation'

Collection/excavation number

The reference number given to the object by the collector or excavator, if this is different from the Object number.

Examples: 'ND9999'

Documentation

Publication reference

Information about published sources or images and other illustrations of the object, including bibliographic references.

Care and Preservation of Collections

Stefan Michalski

Senior Conservation Scientist, Canadian Conservation Institute

Introduction to collection preservation

Conservation and preservation literature can often seem to be dominated by huge (and ultimately unachievable) lists of things to do. One can become so busy following parts of this good advice that there is never time to stand back to see if this really is the best way to achieve the fundamental objective of preserving the collection. This chapter therefore adopts a recently developed way of viewing the preservation and conservation of collections as a whole, before focusing in on the details.

At the same time, collection preservation remains an intensely practical business in which detailed practical advice is needed alongside this new way of thinking. Therefore this chapter also contains many practical examples and case studies (based on real events or an amalgam of real cases) drawing on the author's experience in surveying and advising museums, large and small, in many countries, including Egypt and Kuwait. It is not possible to cover all details of care and conservation standards and procedures in such a short introductory chapter, so where useful references exist these are noted.

Deciding priorities and assessing risks

Fundamentally, all heritage preservation, including that relating to museum collections, relies on two stages of decision-making:

1. Selection: what can and should be preserved within the resources available to the museum?
2. Assessing and managing risks: using human and other resources to reduce future damage.

The selection phase is mainly the concern of other chapters of this book, (particularly those on The Role of Museums and the Professional Code of Ethics, and Collections Management). However, it is important to understand that the nature, choice and history of the collections largely determines how much energy and resources the museum needs for preserving its collections.

In both small and large museums, most of the collection arrived long before the current staff. Decisions on acquiring new objects are often disconnected from those who understand special preservation requirements, though increasingly museum acquisition policies call for a condition and conservation assessment before purchasing additional items or accepting donations. As the removal of objects from the collections (deaccessioning) is rare, and often painful, in most cases the museum collections are always growing. They are also always aging.

These facts create two of the fundamental problems of collection preservation. There is constant pressure on storage leading to less than ideal storage and study space and therefore overcrowding. At the same time, the conservation needs of many categories of artefacts increase markedly with the age of the collection. Many items, such as archaeological metals or historic machinery, can deteriorate more rapidly once they have been "saved" by a museum than when they were sealed in the ground or in use in the historic factory.

Although museums tend to assume that the only way to address the imbalance between the needs of the collection

and available resources is to search for new staff, space and money, the museum and its community must, from time to time, pose three questions: Why preserve these particular things? What new things do we want to collect? Why? (See also the *Collections Management* chapter.)

Reducing future loss and damage in a 100 years or more

In both its everyday use, and as a technical term, risk simply means “the possibility of loss.” In the past, museums used the word risk only for the possibility of rare and catastrophic losses, such as fire, theft, war damage, or major natural disasters. In this chapter, “possibility of loss” includes equally the gradual and cumulative damage to collections caused by agents such as damp, insects, light, and pollution. Preservation of collections is the reduction of all and any future losses. It is risk management of the collections.

The terms risk and risk management are widely used now by other fields, including other museum subjects besides preservation of the collections. The chapter on Museum Security provides information on risk management in relation to the overall risks to the museum and its buildings. The Managing People chapter provides information on health and safety risks in relation to staff and visitors. In all applications the basic concept remains the same, reduction of the possibility of loss.

Risk management of collections is not about the next year, or the next ten years, or even our own lifetime. It is about our children’s lifetime, and that of their children, and so on. Experience in risk management of collections has shown that a practical benchmark for thinking about risks is 100 years. The important skill in risk assessment is to be able to find all the different reasons why, in 100 years, your collection will be in poorer condition than it is now, and to describe each of those many reasons in

ordinary words. Later sections will suggest how to do this systematically.

Classifying risks to collections

There are many different ways to classify and list the potential causes of loss and damage to collections. When trying to understand and plan preservation, however, it does help to choose a single viewpoint of these causes and then to apply it consistently. It is also important that the list of causes be complete, so that in our work of preserving the collections, we do not forget something.

This chapter uses the object viewpoint of causes, developed by the Canadian Conservation Institute (CCI), and originally promoted in the information poster A Preservation Framework, (available both in hardcopy and on the web at www.cci-icc.gc.ca). For example, causes of breakage may be staff untrained in safe handling of artefacts, or an earthquake, but in both cases, the cause at the object itself, the agent that acts directly on the artefact, is a direct physical force. There are Nine Agents of Deterioration that cause damage or loss to collections. These are 1 direct physical forces, 2 thieves, vandals, and displacers, 3 fire, 4 water, 5 pests, 6 contaminants, 7 radiation 8 incorrect temperature, 9 incorrect relative humidity. These agents are listed in more detail in Table 1.

The value of this classification is that it helps focus thinking about collection risk management. For example, physical forces (an agent of deterioration) acting on a ceramic object, or an entire collection, may cause deformation, or fracture, or surface loss (risks). The risks are basically the same whether the physical force is caused by an earthquake throwing objects to the floor (a hazard), or caused by a curator moving overcrowded objects during the preparations for an exhibition (another hazard). However, if the artefact is

held firmly by a padded support, then it is protected from all such hazards. In other words, the padded support reduces the risk from physical forces, which may have many causes in a chain of causes. In another example, thieves, vandals, and displacers (a person who moves the artefact to a wrong location) all act on the artefact in a similar way: they pick it up and take it somewhere unknown. The hazards, the ultimate causes, may therefore range from local criminals to absent-minded researchers, but as far as risk management procedures are concerned, the benefits of controlled access, and frequent inventory inspection using good documentation, will be the same.

Table 1 links the agents to their risks and hazards. The distinction between risk and hazard are defined technically by experts from the larger field of risk management (see the glossary at www.sra.org) but the ordinary dictionary definitions contain the essence: Risk means “possibility of loss”, hazard means “source of danger”. (The interesting origin of the English word hazard is the Arabic word *az-zahr*, meaning the dice used in a game of chance. Danger and chance have always been linked in human affairs.) Whereas a list of all possible hazards is indefinite, as is a list of all possible risks, the list of Nine Agents of Deterioration is, mercifully, complete.

As an example of all the terms (agent, hazard, risk) consider the risk of colour fading in a textile on display. The agent of deterioration is the light reaching the artefact surface. The intensity of this agent can be measured by a simple and relatively inexpensive light meter. (The units of light intensity are lux – lumens per square metre). The hazard in this case could be an inappropriate lighting system, or an exhibit designer who designs to the wrong intensity, or a preparator who placed the textile very close to the lamps, or the maintenance technician who used the wrong

replacement lamps, or the daylight falling on the textile from an unprotected (or inadequately protected) window, or the architect who designed the skylights, or the guard who contrary to instructions opens the special curtains intended to control the light in the room.

Preservation of collections involves all museum staff

Table 1 also shows the links to other museum activities and disciplines involved in the control of particular risks. Many activities and specialists in the museum are involved, directly or indirectly, in collection preservation. Curatorial, collections management, documentation, exhibition, security and management staff all have major contributions to make.

Teamwork and shared responsibility are now widely recognised as essential elements of modern museum management and operation, and this applies especially to achieving effective preservation of collections. This is not just a theoretical issue: it is essential in ensuring that the museum’s limited resources are used effectively. In the author’s experience, small museums practice teamwork and shared responsibility naturally. They are better able to see the whole picture, better able to incorporate new preservation advice, and better able to coordinate layers of preservation than staff in large museums. In large museums, hierarchy, specialization, and competitiveness often displace teamwork and shared responsibility. In such situations, a shared vision of preservation, alongside other museum functions, will only emerge if this is part of the enthusiastic leadership of senior management.

The collection preservation cycle

Preservation of collections is an endless process. Activities can be generalised as a cycle that repeats, shown in figure 1. Each of these stages in the cycle will be explained later in this chapter.

Table 1. The Nine Agents of Deterioration

Agent of Deterioration	Risks of the Agent (Form of loss or damage, and the vulnerable collections)	Hazards (Sources and Attractants of the Agent) Partial list	Some other activities and disciplines involved in management of each risk
Direct physical forces e.g., shock, vibration, abrasion, and gravity	Breakage, distortion, puncture, dents, scratches, abrasion. All artefacts.	Earthquakes. War. Poor handling. Overcrowded storage. Transit inside and outside the museum.	Conservation.* All museum staff for detection, handling, and for emergency response. Building cleaning services. Emergency preparedness, museum and government.
Thieves, vandals, displacers i.e. unauthorized human access and removal. 1 Intentional 2 Unintentional	1 Total loss, unless recovered. All artefacts, but especially valuable, and portable artefacts. Disfigurement, especially of popular or symbolic artefacts. 2 Loss or misplacement. All artefacts.	Professional and amateur criminals. General public. Museum staff. Highly visible precious artefacts.	Security. Collection management. Curators and researchers. Local police.
Fire	Total destruction with no recovery. Scorching. Smoke damage. Collateral water damage. All artefacts.	Exhibition installation. Faulty electrical, lighting systems. Arson. Careless smoking. Adjacent buildings.	Security (fire). All museum staff for detection. Local fire service. Conservation*
Water	Efflorescence or tide marks in porous materials. Swelling of organic materials. Corrosion of metals. Dissolution of glue. Delamination, tenting, buckling of artefacts with layered components. Loosening, fracture, corrosion of artefacts with joined components. Shrinkage of tightly woven textiles or canvases.	Floods. Storms. Faulty roofs. Internal faulty water and sewage connections. External faulty water and sewage connections. Wet pipe fire suppression systems.	Conservation.* Emergency preparedness, museum and government. All museum staff for detection, and for emergency response. Building cleaning services.
Pests 1 Insects 2 Vermin, birds, other animals 3 Mould, bacteria (see Incorrect Relative Humidity: damp)	1 Consumption, perforation, cuts, tunnels. Excreta that destroys, weakens, disfigures, or etches materials, especially furs, feathers, skins, insect collections, textiles, paper, and wood. 2 Consumption of organic materials, displacement of smaller items. Fouling with faeces and urine. Perforation, fouling of inorganic materials if they present an obstacle to reaching the organic material.	Surrounding landscape. Vegetation habitats near building perimeter. Garbage habitats. Incoming building materials. Incoming artefacts. Incoming staff, visitors. Spilled foods.	Conservation.* Building operations. Food services. Exhibit design. All museum staff. External pest control companies. External biologists for identification.

A case history of museum teamwork: sunlight and guards

A curator acquires an old textile from a local family. She has wanted it for the museum collection for many years. The textile was kept in the great-grandmother's dowry chest. They have agreed to give it to the museum if it goes on display in a prominent place. She studies the wall where she wants to mount it, and notices that at this time of day a bright beam of sunlight falls on the wall. The window shutters had been opened by the cleaners, and kept open by the security guard because they want ventilation. The curator asks about closing the shutters but they complain that it will be uncomfortable while they work. She has read somewhere that light can be damaging to textiles, but she is not sure.

Her museum is too small to have a specialist so she contacts an expert at the national conservation institute. After correspondence, he advises her that indeed, some of the colours in the textile she describes will probably fade significantly in two years if they receive two hours of direct sunlight each day, and even the indirect daylight in the room will probably cause fading in ten years. She decides to focus first on the biggest risk, the direct sunlight. She arranges a meeting with the cleaner and the guard in her office. She invites them to inspect the wonderful textile, explains its historic connection to the community, and explains the dilemma. After some discussion, the guard suggests that now that he understands the reasons, he could close the shutters for the two hours that the sun is a problem. He could move his seat to another open window without sun during that part of the day.

During the discussion the cleaner remarks that last year, when it rained, (when the curator was on holiday) she discovered dirty water on that wall from a roof leak, but she cleaned it up. She said she did not know who to tell. Perhaps that might also be a problem? The curator realizes she must speak now to the display case maker, and the man responsible for the building roof, to solve the water risk. The cleaner and the guard feel more attached to the museum collection, and understand that they too have a recognized role to play. They are, after all, the staff who look most closely at the exhibit room every day, and their observations form a valuable part of collection monitoring.

Exercise: Recall any teamwork experiences, positive or negative, or, if it has never happened, imagine where and when in your museum you could be involved in sharing such knowledge. Draw on a sheet of paper circles representing at least 3 or more individuals in your museum and show by arrows connecting the circles what knowledge or activity is shared. If there are organisational barriers between individuals, draw heavy lines between the two, that block the arrows. Does your museum look connected?

Some specific things, such as building a better storage room, can provide benefits long after they are completed. Other things, such as monitoring the room for insects, must continue indefinitely (with its own cycle).

More subtly, the planning and design of the new room, and the decision to allocate time and resources to

the insect monitoring, must themselves be part of the general cycle of preservation.

Who takes the preservation leadership roles?

Traditionally, museums have fragmented the preservation cycle, especially larger museums. Much of the reorganization of museums in the last 20 years has

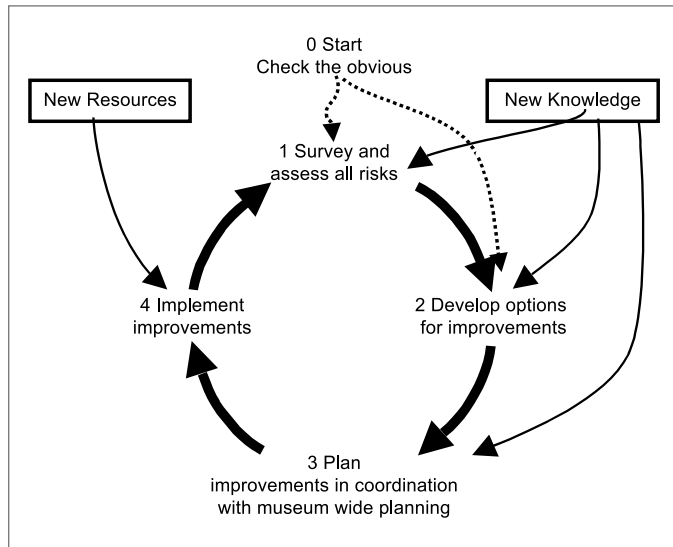

Figure 1. The collection preservation cycle, that must be coordinated within other museum planning cycles.

centralised collections preservation responsibilities under a Collections Management Department or unit. Within it, there may or may not be Conservation Department. The Security Department is usually separate from the Collections Management unit, while planning often takes place in each Department separately, with only the Director's Office able to coordinate policy and decision-making. However, in a very small museum, these are all just different roles that one or two people share.

In a large museum with a separate Conservation Department, the chief conservator typically takes the lead in the condition survey and collection risk survey of the collections, and in developing possible options. Alternatively, it may be the collections manager who leads the assessment cycle, while small museums often hire in on contract a conservator with experience in surveying. In some countries the cost might be paid through a government grant, while some countries have permanent

government-funded agencies that will undertake surveys and give advice. In any of these cases the surveyor or surveyors writes a report that describes the risks, and usually makes recommendations for improvements. The report then becomes part of the museum's planning documents.

Regardless of who takes the lead in performing the survey and in planning the preservation cycle, the Director must take a key role, as this will contribute to the overall museum planning process.

Other types of conservation survey

There are several other possible forms of survey in addition to the model emphasized in this chapter, with a range of names, for example preventive conservation surveys, conservation surveys, or collection surveys.

Some organizations have developed special survey forms that allow standardized information to be collected across many museums in a region. The answers form a description of the museums preservation activities and their facilities, but provide no analysis of what it all means to collection preservation. They usually rely on an expert to perform the survey, and they always rely on an expert to interpret the answers. Organizations have recognized this problem, and developed surveys that suggest guidelines for "good practice. Thus, the museum can compare their own situation with the national or local "best practice" in relation to preservation.

A more traditional type of conservation survey is the collection survey. Some of these have been automated in software. The purpose of such surveys is an assessment of the degree of damage of each artefact, or of the average artefact. Information may also be collected on an estimate of restoration work necessary for each damaged artefact, and even on such work previously executed.

All these issues of different surveys, and their role in museum life, are described well and in detail in Susan Keene's excellent book, (Keene, 2002) The author's own organization, the Canadian Conservation Institute, is working on a computer based system that will contain many detailed questions, with an encyclopaedia of expert risk assessments of the many possible answers, but such a tool is still in the future.

Where is conservation and restoration in all this?

One hundred years ago, the only job of those responsible for the care of museum artefacts was restoration, i.e., the repair and reconstruction of precious objects, one at a time. In the last fifty years, this profession transformed to that of "conservator/restorer." Conservation emphasizes treatments that clean, stabilise, and strengthen the artefact. Conservators will also sometimes restore, reconstruct old damage, but without attempting to deceive the viewer. It is still, however, treatment of one artefact at a time.

Conservators recognised the need to prevent new damage, and discovered that prevention methods could be applied across whole collections. This is called "preventive conservation" as compared to treatments that are now called "remedial conservation." The approach described in this chapter, risk management, expands the preventive conservation idea by insisting on a method that compares the effectiveness of each major category or item of preservation expenditure, current or planned.

Conservation, even restoration, of some special artefacts, is still necessary in museums, especially for works of fine or applied arts, archaeological materials, or historic materials that the museum wants to display. For large museums, there may well be a Conservation Department which performs all these functions, and which can also take the lead responsibility for the

preservation ideas in this chapter. In small and medium size museums, conservation is available only by contract of an independent specialist, or in many countries, by a state sponsored conservation facility.

For a detailed definition of the conservator/restorer by the international organization that represents them, see the ICOM Conservation Committee web page, www.icom-cc.org. This also lists news of all its conferences, working groups and publications. The other international agency that all those working in preservation of collections should know is ICCROM, www.iccrom.org, an intergovernmental organisation established in Rome in 1959. It is the only institution of its kind with a worldwide mandate to promote the conservation of all types of cultural heritage, both movable and immovable. It aims at improving the quality of conservation practice by providing information, advice, and training, and by raising awareness about the importance of preserving cultural heritage, particularly though not exclusively in its more than 100 Member States.

Step 1: Check the basics

A list of the basics

There is a famous management maxim called Pareto's Law that says that most of an organisation's benefits (80%) are achieved by a small fraction (20%) of the organisation's efforts. In giving advice to museums about preservation of collections over many years, one does indeed discover that most of the preservation is achieved by a short list of recommendations, which we can call "The basic preservation strategies" or just "The basics". So, before proceeding to the refinements of risk management, it is useful to check the basics first. These are given in the box titled "The basic preservation strategies". Generally, one does not expect a large museum to have missed any of the basics, but the list does apply frequently to smaller museums, or to large museums with no resources.

The basic collection preservation strategies

Basic strategies that address all or many agents at once

- 1 A reliable roof. Reliable against local precipitation, covering all organic artefacts (and preferably most inorganic artefacts.) While this is obvious to even people outside museums, it also applies to large objects, such as historic vehicles, or historic machines with paint. They cannot be expected to survive many years if exposed to sun and weather.
- 2 Reliable walls, windows and doors that block local weather, local pests, amateur thieves and vandals.
- 3 Reasonable order and cleanliness in storage and displays. The word “reasonable” is crucial. It does not mean spend most of your time on obsessive neatness, which provides very little benefit, and can even be counterproductive. It means keeping sufficient order that objects are not crushing each other, that inspection and surveys are easy, that objects are raised off the floor, and that object retrieval is easy. It means sufficiently clean that pests are not given habitats, that metals do not accumulate corrosive dust, and that porous and difficult to clean artefacts are not soiled.
- 4 An up-to-date catalogue of the collections, with location of artefacts, and photographs at least adequate for identification of the object if stolen, and preferably adequate for identification of new damage.
- 5 Inspection of collections on a regular basis, in storage and in exhibits. This becomes especially important in museums that have limited resources for other strategies of preservation. The time period between inspections should be no less than the time it takes insect pests to mature from eggs (approximately 3 weeks for the clothes moth). Inspect not only for new damage, new signs of risks, but also for thefts.
- 6 Bags, envelopes, or encapsulation used wherever necessary. Except where other rigid boxes are already provided, this includes all small and fragile objects, all objects easily damaged by water, all objects easily attacked by local pollution, all objects easily attacked by insects. These enclosures must be at least dust-proof, preferably airtight, waterproof, pest resistant. Transparent polyethylene or polyester is the most reliable, such as food quality bags (e.g. “Zip-Loc” TM). There is a large literature on details of these methods for textiles, archives, coins, etc.
- 7 Strong, inert backing boards for all delicate flat objects, to support, and to block many agents from behind. This includes manuscripts, paintings on canvas, paintings on paper and board, wall maps, stretched textiles, photographic prints, (both in storage and on display). For any that have front surfaces vulnerable to pollution or water or vandalism, provide protection by glass.
- 8 Staff and volunteers are committed to preservation, are informed and appropriately trained. Basic strategies that address a single agent that is a high risk to most or all of the collection
- 9 Locks on all doors and windows. These should be at least as secure as an average local home, and preferably much better.
- 10 A detection system for thieves (human or electronic) that has a response time less than the time it takes an amateur to break the locks or windows. If not possible, the most valuable artefacts are stored in another, more secure location, when the museum is unoccupied.
- 11 An automatic fire suppression system, i.e., sprinklers (or other modern systems). This can be considered non-critical only if absolutely all building materials and all collections are non-flammable, e.g., ceramic collections in metal and glass cases in a masonry building with no wood joists.
- 12 All problems of sustained damp are addressed quickly. Damp is a rapid and aggressive agent, causing many risks, such as mould, corrosion, and gross distortion. Unlike fire, floods, and insects, it is so common it is often tolerated. The two usual sources of damp are small water leaks and condensation due to large changes in temperature drops (as at night). Move the collection away from the damp. Fix the water leak. Ventilate against condensation.
- 13 No intense light, no direct sunlight, no powerful electric light, on any coloured artefacts, unless one is sure the colour has zero sensitivity to light, e.g., fired ceramics, fired glass enamels.

Why are these so basic?

The basic items in the list can reduce many different risks at once, often at low cost, or they reduce a single catastrophic risk that could affect all the collections and perhaps the museum itself. In the case of the first two (roofs, walls etc.) they do both. Reliable roof and walls block all nine agents of deterioration, not always perfectly, but always to a large extent. This fact may seem so obvious as to be facile, but for many museums guaranteeing a “reliable roof” and “reliable walls” is not so easy. In recent years there have been many reports that some of the most famous international museums have suffered from extensive water leaks dangerous for the



Figure 2. A simple roof structure built over a particularly important part of an archaeological site near a museum. Notice the subtle slope and gutter to direct rain away from the protected area, and avoid rising damp problems in the walls. A small price, a lot of effective preservation. All photographs in this chapter are by the author, Stefan Michalski, Canadian Conservation Institute, all except figures 9,10, made during teaching or consulting projects for UNESCO or ICOM, in or near Cairo, Aswan, and Kuwait City, between 1986 and 2002.

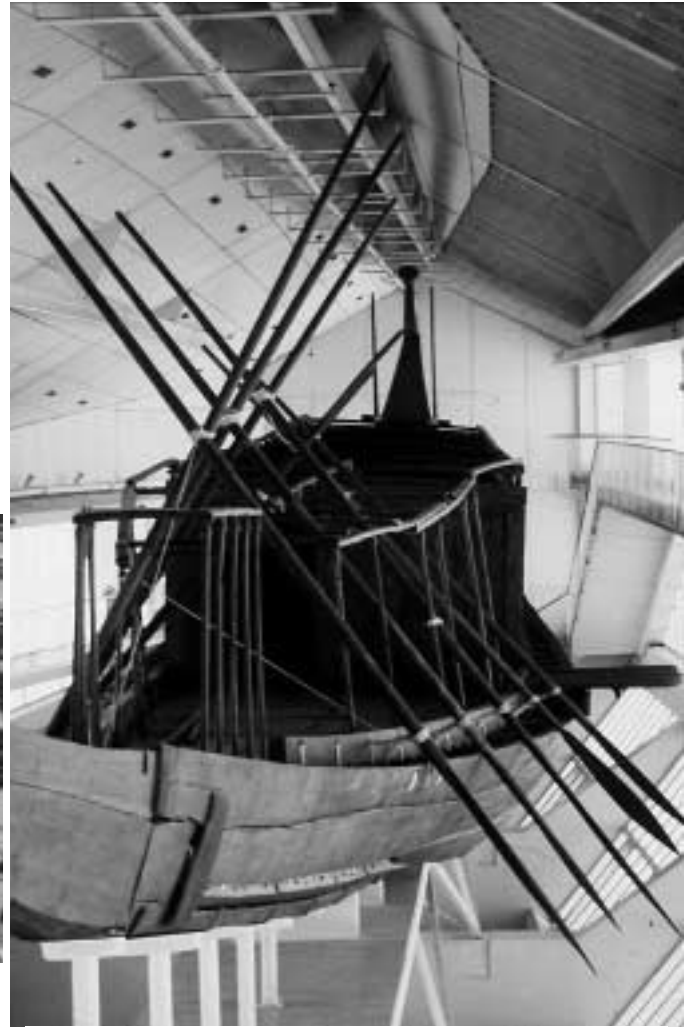

Figure 3. The Solar Boat in its own building, near the great pyramid. The need for sprinklers to control fire risk is obvious, but what are the risks from incorrect humidity and temperature for such an object? How can we know? What is the best way to achieve control reliably?



Figure 4. A papyrus manuscript on display in a small museum. Sandwiched between two layers of glass, and taped. A traditional and very cost-effective form of collection preservation. Provides a sealed enclosure that blocks water, pests, contaminants, and incorrect humidity. Provides protection from many, although not all, physical forces. Easily cleaned without harm to the artifact.

collections because of lack of proper maintenance or renewal. Besides, many large or immovable artefacts are left outside. In figure 2, a simple roof is installed over the most important and vulnerable part of an archaeological site, nearby its associated museum. On the other hand, one can argue that perhaps the modern building around the solar boat (figure 3) with its extensive windows in the desert sun, does not reliably block the heat of local weather (unless the air-conditioning unit is functioning). At the opposite end of the scale very simple and inexpensive measures such as the use of suitable plastic bags, backing boards, or glass, can make a big difference to the protection of the collections, and will protect against most hazards other than burglary and fire. Figure 4, and a later example (figure 10), show these simple but highly effective methods in action.

Step 2: Survey the risks

When to start doing a survey, and how long will it take?

To identify risks to the collection, one can just react to situations as they arise, as did the curator in the case study no. 1. Or one can begin with the list of the basics, as in the previous section, and do that until it is finished. An alternative would be to begin immediately with a systematic survey, which will uncover the basics as well as the not so basic.

A simple survey of a small museum might take one experienced person three days, a detailed survey of a large museum may take several people several months. Whether the survey is a simple one, looking for high priority risks, or whether it is a detailed one looking for all risks, large and small, the guiding principle is “systematic and comprehensive”. Too often in preservation of collections, staff have focused on old habits, on trendy new processes, on ad hoc reports, and on dealing with emergencies, real and bureaucratic.

In summary, a simple survey is better than no survey. Soon is better than never. The crucial aspect is to step back from your job, from your normal preservation activities, and look at your museum and its collections with open eyes, looking for anything that could possibly cause damage.

What exactly am I looking for?

The surveyor is looking for all possible risks to the collection. This is the most difficult part of risk assessment to explain, and of course, it is the most important part to make the survey useful. It is the part that benefits most from experience, but it is also the part that anyone can do. It needs common sense, reasonable intelligence, and good eyesight. It helps to have a feeling for the material world, to be what some might call a practical person, but it also helps to be imaginative, since one must imagine everything that might go wrong. It also helps to have a love for the collection, since that usually brings both a detailed

familiarity and a strong concern for the collection's safety.

There are two stages to this search: collecting facts, and predicting risks.

Collecting facts in order to predict risk

The surveyor begins by collecting many facts, motivated entirely by the next step, which is to predict all the potential risks to the collections. The facts are best collected in a systematic pattern, and a suitable and proven model is outlined in the next sections. These facts must not contain any opinion or speculation, and it is necessary to agree where facts end and opinions begin.

The surveyor then predicts specific risks. Each specific risk is predicted by imagining a specific scenario of possible loss or damage, implied by each survey fact, or possibly implied by several linked facts. The key concept is that of imagining a possible loss, and then finding the best available facts to support a quantifiable prediction.

Fortunately, many serious risks can be imagined by common sense, and roughly estimated. Other risks, such as fading by light, is more a matter of scientific knowledge. For simple surveys, one does not need to be an expert to uncover most large risks. One needs only to be systematic.

Sources of facts: visible and invisible

A risk assessment survey relies on two sources of facts, and it reduces time and effort if one approaches each separately.

1. Visible facts. This is the part of the survey where we look with our own eyes, and make observations. One looks at the site, the building, the rooms, the furniture, and the collections.

2. Invisible facts. This is the part of the survey that considers prior history of the museum, current staff activities, procedures, attitudes, planning, as well as many

external sources of data needed for risk estimation (e.g., flood data, earthquake data, light sensitivity data, etc.)

It is easier, though not essential, to keep these parts of the survey separate, simply because the visible part involves walking around the museum, inspecting things, taking notes, taking photographs, whereas the invisible part involves talking to staff and researching relevant documents. It is not critical which part is done first, but it is useful to have a general understanding of museum mandate, preservation policies, old planning documents, before surveying the museum. It is also very helpful to have copies of a floor plan for marking locations of observations.

Surveying visible facts

The collections can be considered as inside a sequence of containers, like boxes within boxes. Each adds its layer of protection. This is shown in figure 5.

The survey of visible facts follows a path from the outside to the inside. The surveyor begins by looking at the site, then at the building and all its features, then moves inside the building and looks at the building from the perspective of each room. For a pattern refined by the author over many surveys, see the Appendix, "A suggested museum survey path, set of observations, and set of photographs."

Take pictures

Pictures capture many details. In the author's experience, photographs not only form powerful elements of a report, they form a practical record for the surveyor. One often notices things while staring at a photograph that one missed while in front of the real thing: did that room have fire sprinklers? Were all the manuscripts under glass, or only some? Were lights on in all cases? A photographic record also preserves facts for future comparative surveys.

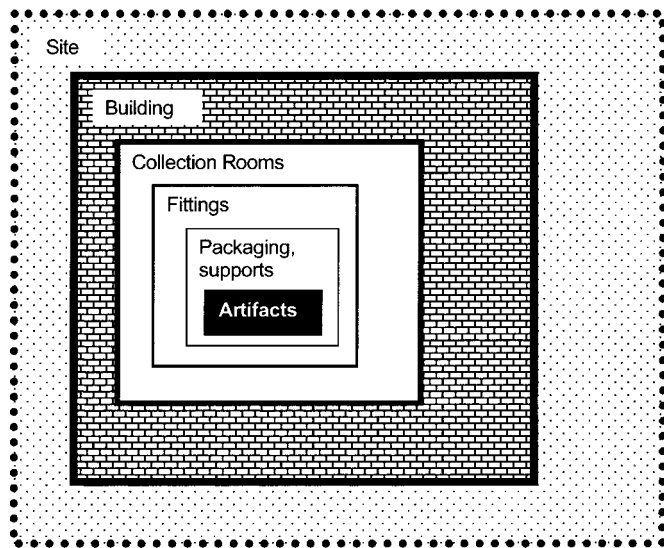

Figure 5. Nested layers around the collections.

In the past, making a hundred good photographs with film was relatively expensive, but with the advent of digital cameras of 3 megapixels or more, a surveyor can take many pictures at low cost and place them within reports or e-mails whenever necessary. It is especially useful to be able to check the quality of the photograph immediately, and to take it again if it is overexposed, out of focus, etc. Typically a survey of a small size museum will generate 100-200 photographs, a medium size museum 300-400. (A digital camera can make it easy for even a small museum to make its collections available over the Internet in due course).

Photographs should always be taken systematically according to a plan, not haphazardly. It is much easier when making use of the photographs later, especially in a museum with several rooms, to take them in a logical sequence. A suggested sequence for photographs is given in the Appendix "A suggested museum survey path, set of observations, and set of photographs". Also, in order to

use photographs to record museum lighting, learn to make photographs of the building and rooms and display cases with the flash turned off. In low light, a tripod may be necessary.

Surveying invisible facts

Surveyors in the past sometimes stopped their survey after they had toured the building and the collections. This missed much of what determines collection preservation. A comprehensive risk assessment needs information from architectural drawings, from policy and planning documents, from manuals of lighting and exhibitions design, etc. It also needs facts that exist only in staff memory, even in museum habits, unrecorded but influential.

Do the staff always leave the back door open on hot days, even if the official policy forbids it? Do the lights in all display cases come on all night when the cleaners need to work? Has the roof or plumbing ever leaked? Where? Does the curator bring new artefacts into storage without quarantining them first, and without checking for insect infestations that could rapidly spread through the museum? Do staff eat food in the storage areas and thus attract both rodents and insect pests? Do staff smoke there? And so on.

Some important sources of information on risks will be found outside the museum. What are the local and regional hazards? Is the museum located on a flood plain or at risk from landslips? What is the probability of earthquakes? What is the frequency with which the identified natural hazards occur, and what is the current trend? (Changes such as the construction of new building developments or roads which obstruct the natural drainage can make a major and immediate difference to the risk of flooding.) To what extent are the collections sensitive to light and incorrect humidity levels?



Figure 6. A glass lamp, with coloured decoration, exhibited and illuminated with an internal lamp.

A basic list in the Appendix gives typical sources and useful questions for invisible facts. Do not be limited by this list: it is only a starting point. You will always need to discover facts for your risk assessment that are not in this list, or any available list. One can rely on two

guiding principles in this search: imagination, and prior history.

Imagination, means allowing yourself to imagine any specific risk that seems plausible. For example, you observe a Syrian glass lamp displayed with a bulb illuminated inside (figure 6). You imagine that perhaps the colours of the glass design will fade if the lamps are on all day. Some one told you yes, all colours are vulnerable to light, but someone else laughed and said, no, not coloured glass. Someone else, more careful, said authentic lamps with coloured glass are not a problem, but later lamps with coloured paint designs are a problem. So, given this plausible imagined risk, it immediately directs you to your requirements: You need to locate facts about Syrian lamps, different forms of coloured design, and the effects of light. Exercise: What do you think should be the lighting decision if there is no information available on the coloured design of a lamp?

Prior history of the occurrence of hazards in the museum provides extremely valuable facts. For example, the question “what are the risks from poor handling of artefacts throughout the museum” can lead you to a difficult theoretical analysis of handling by a complex system, or it can also direct you to ask a simple question of all staff: does anyone remember any stories of artefacts being dropped, scratched, or damaged in any way by handling, even five years ago, twenty years ago? Be sure to explain that the intent is not retribution, but solution. Names are not necessary, only the stories. You will discover that the collective memory of all museums contains stories of such minor events, never recorded before. Collect these: they are precious to understanding your collections preservation. Note that collecting prior history is a slow form of institutional “detect” (though ideally all such occurrences ought to have been properly investigated and recorded at the time). As with all

detection, the purpose is to trigger a response that will lead to an improvement in the risk management in relation to the collections.

Assessing the collection risks, based on the facts

After collecting all the risks one imagines possible in a list, the question arises: which risks are more important, which risks less important? Traditionally, museums made such decisions by a mix of expert opinion (if available), personal opinion, and internal politics. Issues were often fragmented across various departments. These realities will still be part of practical museum decisions, but a survey report that assesses all risks to the collections provides a very useful starting point for discussions.

There are currently only two tested methods of comprehensive risk assessment for museum collections. One is a detailed, arithmetic method developed by Waller (2003) in a large national museum, and applied successfully to many medium and large-scale museums. The other is a method using simple rank order scales developed by the current author, applied successfully to a large number of small and medium size museums in Canada, and taught at several training courses, such as courses in 2003 and 2005 co-sponsored by ICCROM and CCI. Only the rank order approach will be presented here, but a good factual survey can always be converted later into an arithmetic assessment if desired. Rank order scales are common in risk management whenever non-experts do the assessment.

The scales in table 3 consider the following four components of the risk assessment:

How soon?

How much damage to each affected artefact?

How much of the collection is affected?

How important are the affected artefacts?

The magnitude of risk is then the sum of these four components.

The scores from each of the four scales are added together (NOT multiplied). This total score is the Magnitude of Risk due to the Specific Risk assessed. Overall, this simple system suggests the following categories of priority based on total score:

9-10: Extreme priority. Total collection loss is possible in a few years or less. These scores arise typically from very high fire or flood probabilities, earthquake, bombing, and fortunately, are rare.

6-8: Urgent priority. Significant damage or loss to a significant portion of the collection is possible in a few years. These scores typically arise from security problems, or very high rates of significant deterioration from bright light, UV, or damp.

4-5: Moderate priority. Moderate damage to some artefacts is possible in a few years, or significant damage or loss is possible after many decades. These scores are common in museums where preventive conservation has not been a priority.

1-3: Museum maintenance. Moderate damage or moderate risk of loss over many decades. These scores apply to the ongoing improvements even conscientious museums must make after addressing all of the higher risk issues.

Later in this chapter, there are worked examples of risk assessment using these scales.

It is not essential to use these scales in a risk assessment. A surveyor can choose simply to use terms like high, medium, and low, for risks, or “Needs to be done this year” versus “Can wait for ten years”. What matters in the end is that the museum should be able to point towards some rational and understandable method in the survey for making some form of assessment, and that the entire museum and its diverse systems have been systematically surveyed.

Table 3. Simple scales for risk assesment

How soon? (rate, or probability, of damage)		
Score	Risks that occur as distinct events	Risks that accumulate gradually
3	Occurs about once every year	Damage occurs in about 1 year
2	Occurs about once in 10 years	Damage occurs in about 10 years
1	Occurs about once in 100 years	Damage occurs in about 100 years
0	Occurs about once in 1000 years	Damage occurs in about 1000 years
How much damage to each affected artefact? (proportional loss of value)		
3	Total or almost total loss of artefact	(100%)
2	Significant but limited damage to each artefact	(10%)
1	Moderate or reversible damage to each artefact	(1%)
0	Just observable damage to the artefact	(0.1%)
How much of the collection is affected? (fraction of collection at risk)		
3	All or most of the collection	(100%)
2	A large fraction of the collection	(10%)
1	A small fraction of the collection	(1%)
0	One artefact	(0.1% or less)
How important are the affected artefacts? (value of artefacts at risk)		
3	Much higher than average significance (100 times the average value)	
2	Higher than average significance (10 times the average value)	
1	Average significance for this collection	
0	Lower than average value for this collection (1/10 the average value)	

An example of the maximum possible score

How soon?	3
How much damage, to each affected artefact?	3
How much of the collection is affected?	3
How important are the affected artefacts?	1
Magnitude of Risk (total of above four scores)	10

Notes: It is not possible to score 11 points. If all the collection is at risk, then the importance of each artefact cannot be more than average, and if it is 10% of the collection, it cannot be more than 10 times average value.

Any of the scales can be scored intermediate half values if desired, e.g., 2.5

Step 3: Plan improvements to collection risk management

Five stages of collection risk reduction

All the very many, perhaps thousands, of ways that museums reduce collection risks can be subdivided into five stages: avoid, block, detect, respond, recover.

1. Avoid sources and attractants of the agent.
2. Block all access and paths for the agent (since sometimes step 1 fails).
3. Detect the agent in the museum (since sometimes steps 1 and 2 fail).
4. Respond to the agent after presuming, or detecting its presence (otherwise step 3 is pointless).
5. Recover from the agent's effects on the collections (conserve artefacts, and reconsider what went wrong and plan improvements).

The first four stages are prevention of damage. The last stage is remedial conservation and restoration, necessary only because the preventive stages failed. Of course, much of the damage in museum collections happened long ago, or before it entered the museum. Even the best collection care will not eliminate the need for remedial conservation.

Throughout the remainder of this section on planning improvements, remember that each of the five stages has a role to play, and that successful risk management balances all five. Later, when actually thinking about your own collection risk management, remember that each of the five stages is a powerful way to stimulate thinking about what might be missing in your museum.

Common-sense, good house-keeping, but there are complications

Many authors have noted that the strategies of traditional “good house-keeping” resemble good collection preservation. In other words, a lot of preservation is

common sense. In fact, the “list of the basics” presented earlier would be very familiar to a housekeeper a hundred years ago. On the other hand, some habits of housekeeping can damage the museum collections.

For example, if nearby deserts, or dusty roads, deposit a layer of fine mineral powder on collections, then cleaning the artefacts regularly would seem like a good idea. Unfortunately, two problems arise: abrasion, and snagging.

Abrasion develops when the same dust-cloth is used over and over. Unless it is carefully cleaned every few minutes, the cloth fills with the abrasive dust, and the process of dusting becomes a process literally of sanding the artefacts. The author saw a collection of gilded furniture in Egypt stripped of almost all the gilding, simply because they were regularly “dusted” by cloth. A variation on the cloth problem occurs with feather dusters. The feathers wear quickly, and the spines of the feathers become sharp points that scratch the surfaces they dust. Painted surfaces in small historic house museums often show the multiple scratches of generations of feather dusters.

Snagging occurs with complex objects. It especially occurs with styles of furniture that use elaborate fretwork and inlays, common in Islamic decorative arts. The dust cloth or feather duster snags fragments that have curled or partially delaminated, and flings them somewhere far away! A museum cleaner questioned by the author (many years ago) about this issue angrily defended himself, and stated that his family had performed this function for generations. It was a mistake of diplomacy to raise the issue as a young, foreign expert, and in the presence of his supervisors. In retrospect, it is unlikely that anything changed about cleaning in that museum. Better to have informed the curator, who could later approach the staff member discretely.

A second complication seen repeatedly by the author in museums with a dust problem is water damage. The most common form of institutional floor cleaning, inside and outside, observed by the author in all the hot regions of the world East to West, appears to be mopping with copious amounts of water, often thrown in puddles on the floor, either early morning before the museum opens, or immediately after closing. Part of the reason is probably the pleasant cooling effect, part of the reason is the prevalence of tile floors and stone walls, with no wood components. Part may be the ritual of cleansing with water that occurs in many cultures where water is scarce. History and sociology aside, the very real risk as far as preservation is concerned, is the risk of water damage, as shown in figure 7. Here, in a major museum, no one in authority has noticed or acted on substantial change in the artefacts appearance, despite the obvious clues given by the plastic sheet protecting the eye. There is no damage under the plastic. And the nails holding the plastic are corroding very fast, and staining the wood even more. Obviously the protection of glass, such as figure 8, is better for a wood sarcophagus.

Find individual solutions, and then common solutions

For each risk identified and assessed (or at least for all risks selected as significant) a collection risk surveyor then develops a solution, or maybe several options for a solution. If possible, the surveyor estimates cost, or at least identifies the type and scale of resources required. In business terms, this then permits the museum to try a cost-effectiveness calculation: how much risk does each option control, and how much does this control cost? Individual examples are provided in the section on Examples of specific risk assessments and individual solutions.

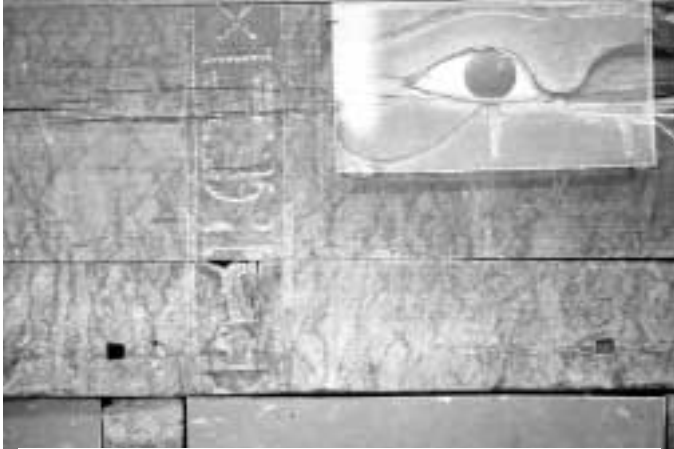

Figure 7. A wooden sarcophagus on open display, on the museum floor. The water stains are from many years of water splashed during daily floor cleaning with wet mops, a common procedure in hot dusty climates. The plastic protection over the eye reduced risk of vandalism, and also blocked the water splashes.

Recommending individual solutions works well if the survey has identified a few high level risks that have unrelated solutions. In such cases, simple business logic suggests that the museum should implement solutions to all high-level risks in order of increasing cost.

Finding common solutions to groups of risks is also possible, but may require exploration of different options, different solutions to each high-level risk. One then looks for options that address several risks at once. It may be more cost-effective to spend a little more on an option that solves several risks than to implement the lowest cost option of each risk.

The only planning dilemma arises when many small risks can be solved at low cost, whereas the one large risk can only be solved at high cost. Actually, this is not a dilemma so much as a risk management trap, or fallacy, that many museums have fallen into, and suffered as a result. Solving the low level risks that we can afford, or



Figure 8. A sarcophagus in a modern museum case. While it is obvious that it blocks water from the floor cleaners, it is not obvious if it can or cannot block water leaks from above, or insects, or smoke, or pollutants. Close inspection, or design drawings, and probably both, are required for such assessments.

for which we have already assigned staff, makes us feel that we are truly doing our best to preserve the collection. And as noted at the beginning of this chapter, it is not difficult to fill one's time with habits that address low level risks.

Time after time, one sees museums that spend months of labour on special padding for textiles in storage, and do nothing to reduce the risk from the 3 water and sewage pipes that cross the ceiling of that same collection. Or museums that build beautiful wooden cabinets that solve small humidity risks instead of designing the cabinets and building to cope with the probable severe earthquake in a region of high seismic activity. Or museums that conserved paintings at great expense, which then dropped to the floor after installation because no one tested if the hooks were strong, and finally, the numerous museums that neglected to install sprinklers, or even decided not to

install sprinklers because of perceived water risk, and burned to the ground. (It is interesting to note that old photographs of the solar boat museum (figure 3) on some tourist web sites show no sprinklers. Presumably they were added later, not in the original design.)

One last note on finding solutions: it is a common mistake to start thinking of risk management improvements only in terms of building something, or buying something. Many solutions to risks and hazards emerge in the intangible, such as staff training or improved communication. For example, one large museum discovered that over and over, there were preservation mistakes in new display cases (in lighting, supports, polluting materials.) The conservation department and the exhibitions department did not communicate regularly during exhibit design. Conservation was only obliged by museum policy to approve the exhibition at the final stages of installation. By then, it was too late, or too expensive, to make changes. The result was only animosity, and a dysfunctional relationship. The improvement was simple, with no cash cost: conservation was required to send a representative to exhibit design committee meetings, from start to finish. Later, conservation staff admitted that they had no idea that exhibit design was such a complex task, and that the lighting solutions they proposed, such as fibre optics, could be so expensive. (For an excellent resource on conservation issues and the exhibit design process, see the CD-ROM entitled *Exhibit Conservation Guidelines: incorporating conservation into exhibit planning, design and fabrication*, by the US National Parks. (Raphael, c 2000)

Find integrated preservation solutions

The word integrated has recently emerged as another preservation management ideal. It means to bring an

independent and isolated activity into the larger system. The goal is not just a grand theory, but a practical holistic operation. It is a relative term, inasmuch as some apply it to the integration of pest control within the museum operations, others propose it for all preservation activities within the museum.

The challenge is this: An integrated method is a diffuse and system wide method that cuts across many independent museum activities. For example, integrated pest control requires, among other things, cleanliness under cabinets, plus reduced vegetation around the walls, plus mandatory quarantining of new artefacts, plus no food in curator's offices near storage, etc. Integrated relative humidity control requires that cabinet design and building mechanical systems and conservation monitoring form a complete and cost-effective system. Implementing an integrated approach depends on the cooperation of many museum staff and their departments. Sustained teamwork depends on shared understanding. Successful integrated solutions always begin with successful communication.

Find sustainable preservation solutions

Finally, the most modern concept in heritage preservation is "sustainable". A new university programme in sustainable heritage, for architects, engineers, and conservators, has just opened in the United Kingdom. (www.ucl.ac.uk/sustainableheritage) In essence, sustainable means the organization takes no more than it can give back. There are two flavours to its use in heritage preservation: environmental, and financial.

When thinkers in the conservation of the environment apply sustainability to heritage, it means that a historic museum building is a resource, and any plan to tear it down and replace it by a new building must consider that each brick thrown in the garbage, and replaced by a

new brick, represents enormous “taking without giving” from the environment.

At a more day to day level, consider museum lighting. Fluorescent lamps are “low energy lamps” and by using them in museum lighting, one saves energy three times. First, one saves at the lamp, which consumes much less electricity for the same light as incandescent lamps (including quartz halogen lamps loved by exhibit designers.) Second, one saves on the electricity to operate the air-conditioning that is needed when the museum is full of hot incandescent lamps (significant in many museums, especially in hot climates). Third, the size of the air-conditioning plant can be smaller, and hence the energy consumed by its manufacture and replacement is less.

Unfortunately, many compact fluorescent lamps contain a significant amount of complex electronics, and this becomes garbage when the lamp is replaced. Newer models of compact fluorescent lamp separate the electronics from the lamp (as do all large fluorescent lamps). Still, as any lighting designer will attest, using fluorescent lamps successfully in museum displays is not easy.

The other flavour of sustainability comes from the field of economics. Pragmatists here use the word simply to mean that the local finances of the museum will balance, not just this year, but indefinitely. The last two decades have seen many museums worldwide discover that they were not sustainable in these terms. Part of what drove their operating costs far beyond their resources was the installation of complex mechanical systems for temperature and humidity control. These expensive mechanical systems were driven by “conservation standards”, which will be examined more sceptically in the section Museum temperature and humidity guidelines.

Plan within general museum planning, and beyond

The collection preservation cycle only has a meaning within an organisational structure that can implement it, such as your museum. Other chapters in this book deal with the planning and management of the museum as a whole. There will be times and places identified within that planning process for leaders of the preservation cycle to speak and plan within the larger museum planning cycle. The objective at museum planning meetings is not simply advocacy of preservation needs, but creative and imaginative collaboration. Listen to the other museum interests.

Recall the case history of the curator with a recent donation of a textile from an important local patron. Besides planning a good preservation (low risk) display, the museum may wish to consider the public relations aspect. Keep the donor happy, and other donors, and more gifts may appear. Also, the exhibitions and education departments may ask to present conservation and preservation aspects of the textile, such as how the museum treated the textile, how the textile was fabricated locally, what historic dyes might have been used, and thus full circle, why low lighting is necessary. Each of these possibilities are real, and each has occurred in successful museums.

Some readers of this chapter will become, or may be already, in positions of importance within national or even international heritage agencies. These agencies are being asked to demonstrate their results, and their cost-effectiveness. All are beginning to consider a preservation cycle of their own: assessment (where surveying intangible facts is called consultation with client groups), then option generation, then planning (coordination with client groups again), and only then, implementation. The next cycle of assessment then looks

for results from implementation of the previous cycle, as well as new or unaddressed risks.

In fact, the author based the preservation cycle on a model taught by a lecturer on government program development, where the idea that the process was a continuing cycle, not a straight line with a start and a finish, was considered a breakthrough! Historically, though, the straight line project model, with a final ending, is understandable. New goals tend to have a short List of the Basics, which can be approached once, and completed. For old goals, however, like collection preservation in an established museum, improvements are not obvious, cost-effectiveness is far from obvious, and the results often uncertain. The cycle must be repeated, and new assessment data injected.

Examples of specific risk assessments and individual solutions

Figure 9 . Islamic manuscripts (books in horizontal cases, single sheets in wall cases) in exhibit cases illuminated by electric lamps

A display room full of Islamic manuscripts, displayed as shown. Modern electric lamps. Modern, solid, display cases. Overall impression of collection preservation: excellent. Perhaps there are significant risks to the collection, or perhaps none. Only careful assessment can determine this.

Assessment of light fading risk in figure 9.

A measurement with a light meter is necessary, plus information on exposure time, plus some information on the colorants in the artefacts. If for example, the light intensity at the manuscripts is 100 lux, and the curator advises that the lights are turned on by guards only when visitors enter, which is, on average, 3 hours per day most days of the year, gives a light dose per year of 100 lx times 1000 hours = 100,000 lux-hours a year. Larger units can be expressed in million lux-hours units (Mlx h) (as in e.g. Appendix 4 of this



Figure 9. Islamic manuscripts on display in a small, modern museum. The cases appear well made, and the lighting appears of low intensity, with no lamps inside any cases. Examples of more precise collection risk assessments of this room are presented in the text.

chapter). The 100,000 lux-hours of the above example could therefore be expressed as 0.1 Mlx h. If the weakest colorant in the manuscripts is in the category of High sensitivity (a plant dye, for example) then we see from the table that if there is a UV filter on the lamp, then about 1 Mlxh will cause a just noticeable fade. That will take about 10 years. And if full fade takes about 30 times longer, then 300 years for full fade. So, in terms of the scales:

How soon? <i>(in the middle between 0 and 1)</i>	0.5
How much damage? <i>(this is a curatorial assessment, typically 1 - 2)</i>	2
How much of the collection? <i>(for example, consider it is a small museum)</i>	2
How important are the artefacts? <i>(for example)</i>	1
Total magnitude of risk	5.5

If one chooses to use an estimate based on the beginning of the fade, then the “How soon?” score rises to 2, but the “How much damage?” score drops to 0. The result is a total of 5, similar. Either approach is correct for purposes of assessment. If one knows that the colorants are all mineral pigments, except one red, which you know is madder, medium sensitivity to light, then it takes 30 Mlxh, almost 10 000 years for a full fade! It is better in such extreme examples to use the category of just noticeable damage (score 0) which occurs in 300 years (score 0.5) to obtain a total of 3.5 for the above example. This is a relatively small risk, not zero, but small.

Consider the possibility that the electric lighting was not 100 lux, but 2,500 lux, (common with modern spot lamps, and typical of indirect daylight in a room with an open window. Assume the displays were illuminated 12 hours a day, not 3. The rate of fading would increase 100 times. All the above totals would jump 2 points, to 5.5 for medium sensitivity colorants, and 7 for high sensitivity colorants, an urgent priority risk. In fact, if the display was already ten years old by the time the survey was made, any high sensitivity colorants would already be substantially faded. In the author’s experience, staff find such results unbelievable, impossible, but I have seen many examples of museum exhibits of about 10 years age, where certain colorants were completely destroyed in that short period, although the artefacts were over a hundred years old. The fact is, ordinary people, scholars, owners, do not leave manuscripts and precious textiles under intense light day after day, year after year. Ironically, only museums, with a mandate of preservation, do that.

The options for reducing light fading risks are relatively few, and predictable.

- 1 Electric lighting hazards. Reduce lamp size and number. Cost: from low (lower wattage bulbs) to moderate (new lamp fixtures).

- 2 Daylight hazard. Block windows. Cost: from low (paint the glass, add curtains) to high (special shutters, blinds, building redesign). With very important manuscripts and unavoidable bright daylight in museums with windows, use photographic reproductions for display. Cost: price of a photograph.

Assessment of water risk in figure 9:

A surveyor needs to look up at the ceiling, perhaps above the louvers, and check for pipes. Also check the floor above, is there a bathroom? Laboratory sink? Suppose, for example, that the surveyor identifies a toilet in the floor directly above, plus 3 other pipes crossing the room. As a starting point, it is cautious but reasonable to estimate each such item may each leak once in 30 years. This is their expected life in industrial terms. So, 4 leaks in 30 years, randomly that is one event per 10 years. Estimate that each leak covers 1/10 the area of the room. So the risk assessment becomes:

How soon?	2
<i>(one event each 10 years)</i>	
How much damage?	2.5
<i>(many water-based inks and paints may be lost)</i>	
How much of the collection	1
<i>(1/10 of the room gets wet each event)</i>	
How important are the artefacts?	1
<i>(as previous example)</i>	
Total magnitude of risk	6.5

This magnitude of risk is in the level of “urgent priority”, even though absolutely nothing may happen for 10 years, or even 30 years. This is the nature of “probable” loss. The surveyor cannot guarantee leaks, but as an advisor, the surveyor must warn based on probability. Still, the estimate feels wrong, looking at the picture.

It is wrong. The assessment above assumes open display. Pipes and plumbing above open display definitely create a

high risk situation, (unfortunately common in modern museums that favour open displays). In figure 9, however, all manuscripts are in well-made cases, with tightly sealed glass lids. Close inspection of the detailing shows they would be very good at shedding water, especially the horizontal ones that slope. Many expensive new museum cases are useless at shedding water, or even worse than nothing, because they funnel water towards the artefact through lamp openings. Cases such as the one in figure 8, are very difficult to judge for water hazards. The author estimates perhaps only 1 in 30 books in the cases in figure 9 would get wet if all cases were sprayed with water. In addition, all the single vertically displayed manuscripts are encapsulated in plastic envelopes with sealed edges. About 1 in 10 of the plastic envelopes appears to have openings that would allow water from above to enter. (Plastic envelopes can be even better, I would estimate only 1 in 100 of those bags in figure 9 would leak even if the box filled with water.) So, for open books in cases, the risk drops 1.5 points, to 5, and for the encapsulated manuscripts inside the cases, it drops another 1 point, to 4, moderate priority.

The options for reducing the water risk are:

1. Rerouting the plumbing. Cost: moderate to high.
2. Establishing a special maintenance schedule for the plumbing above the display area.
3. Carefully inspecting and improving the case seals and encapsulation seals, especially under the pipes to make their ability to block water even better than estimated. Cost: low.

If a museum is considering design and purchase of many cases, or many cabinets for storage, and there is an unavoidable water hazard above, such as a water storage tank on the museum roof, it makes sense to design and test prototypes to resist water spray.

Exercise: Look at figure 8. How might you determine

what is the risk of water entry from above?

Exercise: Go and look at one of your display rooms. Try to assess the risk of light fading, and the risk of water from above. Remember to begin by imagining the future, the next 100 years. Describe a scenario to yourself, then try to assess it with the scales. Focus - it is easier to begin with a specific type of artefact, a specific part of the room. Practice generalising later.

Figures 10 and 11. Two different boxes of small textiles, badges

Figures 10 and 11 are from two different small military museums in Canada. Like many museums, military museums collect costumes, textiles, and they collect large numbers of very small things that have value only as large sets of something. Looking at figures 10 and 11, one can see by now that the plastic food bags with “zipper locks” would be a very cost-effective way to reduce risk from water. It is also a way to reduce risk of tarnishing due to pollution. These could also be small items of clothing, shoes, hats, with metallic threads, from Islamic or ethnographic collections. Water and pollutant benefits can be estimated, perhaps not precisely, but with obvious scenarios in mind. Here, we consider the effect of the bags on two more difficult risk assessments: physical handling, and insects.

There is no doubt that collection conservators recognize the advantages of such bags, made with relatively heavy polyethylene, for protection from physical handling, and from insects. Curators like the advantages for reliable labelling, and for keeping fragments together. Label cards placed inside the bag strengthen even further, and make small pieces more visible. Natural history collections, archaeological collections, historical collections, all have such material. We know it is a good idea, but can the benefits be assessed meaningfully?



Figure 10. A box of military badges and textile insignia, without identification or separation from each other, in a small Canadian museum.

For physical handling, the best information for estimates comes from the curators and collection managers or users themselves, especially in small museums where they are all the same person. In this particular example, the curator who had moved his insignia and badge collections into the bags was convinced that the rate of damage was much lower. The question for both curators, especially the one without a bagged collection, would be: How much damage do you estimate occurred to these objects from handling in the previous 10 years, or for as long as you have been in the museum in your memory? Such an estimate would include the effect of how often these objects were searched by users. Perhaps the museum anticipates a great increase in users, 10 times as many users per year would increase handling risk 10 times. These are certainly not easy assessments, but they are necessary before the museum can agree on the priority. If, of course, there is already an easier risk assessment, such as rate of silver



Figure 11. A box of military badges and textile insignia, each in an individual polyethylene "zip-loc" bag, most with identification cards inside, in a small Canadian museum.

tarnishing, or risk of water damage, or risk of lost labels, to justify the bags, then an estimate of physical force protection is informative, but not essential.

Figure 3. Solar boat, incorrect relative humidity risk?

The museum building for the solar boat in figure 3 is obviously not typical of local historic architecture. It is the precise opposite of heavy walls, and small windows. It is what is known technically as a low mass building, and it has window area typical of a northern European yearning for light. True, it is called the solar boat, but it is also true the pharaohs (their technical advisers) buried it underground in a well sealed enclosure until 50 years ago. It is apparently a climate controlled building, but almost always that means temperature controlled for human comfort, and possibly the relative humidity is somewhere between 40%rh and 60%rh most of the time, and outside that some of the time. This is not flippancy, this is museum reality all over the world.

Exercise: How would you reliably determine the history of humidity and temperature?

Now the more difficult Exercise. If you did determine the humidity and temperature history, then what? How would you estimate risk?

There was a proposal many years ago, perhaps when the climate control appeared less than perfect, to place a very large amount of silica gel around the boat, which would act as a good humidity controller (called a “buffer”). (See Thomson 1986, ASHRAE 2004, and other sources). Was it necessary?

Most readers will have learned that wooden artefacts show some degree of sensitivity to humidity fluctuations. Some learned it was very sensitive, others less so. The best currently available risk assessments to this question can be found in a very dense table available from the author. (The answer there: little to no risk of fracture for up to a 40% fluctuation in a structure like the solar boat, because each wood piece is free to expand and contract without constraint. This is, after all, designed like a boat, which gets wet and then dry without cracking. They just get loose.) The uncertain risk would arise if any pieces had been “restored” by a resin). A simplified but unfortunately vague risk estimate is implied in the ASHRAE table of Appendix 3. The fast, very precise answer is this: Humidity fluctuations cannot cause significant risk of fracture or delamination in the future unless they significantly exceed all fluctuations of the past. This past “worst rh fluctuation” is called the “proofed fluctuation of the collection” (long enough for the objects to respond, which in the case of the boat, which exceeds 1 cm thickness everywhere, is at least one full day, and probably many days for most elements. So, a very powerful benchmark for risk assessment is not science of the artefact, but history of the agent. With the solar boat, this is a double-edged sword. It was removed from a very stable humidity in a massive and sealed enclosure, and placed in a risky modern building in the

desert sun. In other words, the risk, if any, has been taken already, unless the building performance deteriorates radically. And the boat looks OK after 50 years. Luck? I think not. I think the best available science suggests this type of wooden artefact is a very low sensitivity to humidity fluctuation. And I think the last 50 years proved that. So future collection managers can take advantage of the knowledge gained by the past. Two clarifications: 1, If there are small fractures and distortions observed in the boat, I suspect it is the long term average rh that is wrong, not all the fluctuations. I was informed that tests in similar burial chambers gave a steady 60% rh. And 2, note that there is no advantage whatsoever (aside from avoiding embarrassment) for a museum to exaggerate the perfection of its past climate control. Whatever happened in the past, happened. Its only value now is as data for future prediction. With humidity fluctuations and wood, leather, paint, textiles, glue, paper, parchment (and other organic materials) the greater the known risks in the past, the smaller the assessed risks for the future.

Exercise: What would you propose as a logical plan for estimating the “proofed rh fluctuation” of the wooden artefacts in your museum?

Exercise: The risks from the other 3 forms of incorrect rh do NOT follow the same concept as “proofed rh fluctuation”. Damage accumulates for each event, such as damp, regardless of previous similar events. Explain.

Figures 12 and 13. Tutankhamun’s lions

Figures 12 and 13 are presented as a cautionary tale about historical evidence. Unlike the solar boat, the artefact in figure 12 is showing clear signs of damage from incorrect relative humidity in 1986. Possibly rh fluctuations, possibly incorrect long term average rh. There is a tendency in museums to use such evidence as proof that



Figure 12. One of the lion heads in Tutankhamun's collection. Photographed 1986. Fracture and delamination of the gilded gesso layer, due to shrinkage of the wood components underneath. The question becomes, when did this damage occur? What are the risks from incorrect humidity and incorrect temperature for such an object?



Figure 13. The same lion head as in figure 12, in a photograph taken by the archaeologist the day the tomb was opened. Although the photograph is not very clear, each of the fractures or delaminations of 1986 is already present, but to a lesser degree.

the buildings current climate control systems are inadequate. It may be true that the building's systems were inadequate, but this particular evidence is weak. Notice in figure 13 that at the time of excavation, the artefact showed much of the same damage, at the same three locations. Access to more clear samples of the original photograph, and access to any available photographs between the two dates would allow a more precise interpretation of the evidence, and its implications for future risk management of humidity control.

Exercise: What important artefacts exist in your museum with similar evidence of slow accumulating damage from incorrect rh, or any other agent? Go and inspect them carefully. Are you able to deduce when in the past the damage occurred? What methods could you establish that would allow the museum to prove that in 1 year, or in 10 years, new damage had occurred?

Integrated risk management of pests (IPM)

Introduction

The material in this section is based on the work of Tom Strang of the Canadian Conservation Institute. His articles (Strang, 2001), and those of others (Pinniger, 2001) published recently in this area should be consulted when planning the museum's full IPM program, especially if insect damage is historically a known problem. Here, all the key concepts are provided, enough for a museum to understand the change from reliance on poison to reliance on IPM, and to begin its methods immediately. As noted in the previous section on integrated methods, the pest control industry adopted the concept and phrase long before museums. IPM is not only useful in itself, it is useful as a risk management model for all other agents of deterioration in museums.



Figure 14. Collection storage in a medium size museum. The overall tidiness is good, there appear to be no water sources overhead, and all but a very few of the large brass cooking vessels are stored without stacking one on top of another. As with many museums, there is a work space in the collection storage area which introduces many hazards, such as constant staff traffic, food, drinks, and considerable dust (in this example archaeological ceramics are being sorted and cleaned). It is not certain which tables are for work, which are museum artefacts.

Avoid sources and attractants

Pests were the agent that initiated the addition of the word “attractants” to this control phrase. Pests cannot be avoided in the external environment, but unlike pollutants, and just like thieves, pests do follow paths towards whatever attracts them. And a fundamental attractant and pathway for pests is a pleasant habitat. One can become specific: the worst attractants are those that mimic the vulnerable collections. Fur, feathers, and wool in collections are especially vulnerable to certain insects, and those insects are attracted towards the museum building by, of course, fur, feathers, animal hair, and anything with the same material (keratins) or



Figure 15. A large museum display hall, 20 years ago, with traditional museum cases from almost a 100 years ago. The cleaners are dusting with a feather duster in the early morning. Daylight streams in. Whether anything is at risk here depends on what collections are present. Unlike the case of figure 7, one can easily clean underneath these cases, and inspect for insect resistance.

similar material (chitins) such as dead insects. Thus, habitat includes the trees and bushes that attract harmless birds and insects, which die, and then become the dangerous attractant. After insects clean-up those items, they look for more...in your building nearby. Vermin and insects in general are also attracted by garbage, especially food garbage. Garbage should be kept at least 20m away from the museum building, and emptied frequently. To repeat, the fundamental principle of first stage IPM: remove as much habitat from the surrounding area as possible. This applies to every layer of the nested enclosures of figure 5. One of the large advantages of display cases designed as in figure 15, as compared to that in figure 7, is that one can successfully ask cleaners to clean up dust (human skin flakes, hairs, etc) from under cases, i.e., habitat.

Avoid does apply directly to sources as well. Insects often enter the museum in new artefacts, or building materials, and often the materials for open exhibit display. Thus another general principle of IPM: quarantine and then inspect all incoming materials, especially the same type of material as your most important or most common collections....wood for wood insects, wool for wool, etc.

Block pathways

The nested enclosures of figure 5, the reliable walls, roof, doors, windows, of the “list of the basics”, all speak to IPM. As do the plastic bags of figure 11, containing their precious bits of military wool. On a less obvious level, IPM speaks of a “sanitary perimeter” around the building, which can be applied methodically around each layer of the nested enclosures of figure 5. Conceptually, this overlaps with removing habitat, but it addresses the specific idea of the narrow band of habitat that acts as a pathway towards the holes and cracks in the enclosure.

Screens are an important detail, as are any openings over 1mm. Insect screens on windows, while common in some parts of the world, are absent in many others. Any museum with especially vulnerable collections, such as woollen textiles, should consider screens on any open windows leading into those collections, and on any ventilation openings for the mechanical systems.

Probably, one of the lucky factors for museums in hot dry climates, given the lack of screens on windows, was the concurrent lack of vegetation and habitat around the building. It is a great irony, and unfortunate reversal, that modern museums in these countries strive heroically to provide pleasant landscaping, watered gardens, restaurants, all to attract pests to their oasis, and then their collections! Such museums should at least consider

the sanitary perimeter concept, i.e., a 1m border of grass and shrub free gravel around the entire building, and special care with garbage removal.

Detect

Adult insects enter a collection, find their habitat, and lay eggs. The larva and or pupa stage destroys your artefacts, becomes adult, and spreads through the collection. This cycle typically takes a few weeks, so it is vital to detect any infestation before the cycle can repeat. If it repeats two, three times, before you discover it, losses will escalate exponentially. One of the most useful methods to emerge in museum IPM in the last two decades is the systematic use of insect “sticky traps”. Although sold to home owners as a means of killing insects, their use in museums is not for killing per se, but for detecting. These sticky traps are placed throughout the collections, especially along insect pathways (the dark edges of walls, etc) then inspected on a regular interval, perhaps once per month. It is important to identify the species of insect, since many are harmless to your collections. (see references for identification sources) Then it is important to maintain records of what you find, and where, and finally, it is important to notice any “hot spots” in your building, and to respond.

Respond

In brief, kill the pests. More precisely, find the infestation that has been detected by the sticky traps, or by routine inspection of the collections, or in the quarantined incoming material, and isolate it immediately, and gently. Dispersing adult insects throughout the collection by uncovering everything is not useful. Wrap in plastic to start, and seal well. Consult the literature, and experts (genuine experts, not purveyors of poisons) for more details. There are several

new methods of killing insects that museums need to know, which avoid poison. One group are called “controlled atmospheres” or “anoxia” and rely on a bag filled with air that has no oxygen. The other methods are called “thermal” and use either very high, or very low temperatures. (Strang, 2001) The high temperature methods can use extremely low cost techniques, such as placing infested artefacts in black polyethylene in the sun for one day. This “solar” method is now well described in the collection preservation literature. (Brokerhof, 2002)

Integrated, sustainable risk management of lighting, pollutants, temperature, and humidity
Risk management replaces rigid standards for the museum environment

Worked examples of the section Examples of specific risk assessments and individual solutions presented a risk assessment and risk reduction approach to issues such as lighting and humidity control. As noted at the beginning of this chapter, most preservation advice and guidelines use a much simpler approach, based on “best-practice” or “standards”. This is especially true of the last four agents of table 1, lighting, pollutants, incorrect temperature and incorrect humidity, known collectively as the “museum environment.” Simple rules are much easier to specify, but the price can become very high, and the benefits arbitrary.

During the 1970s, museums worldwide adopted simple rigid standards for the “museum environment”. These standards were based on extremely cautious estimates of some risks, and oversimplification, or complete omission, of other risks. The targets were unnecessarily difficult and expensive in some situations, and counter-productive in other situations. Although museums are gradually replacing these rigid targets with more flexible guidelines, the rigid targets still dominate

much of the published advice. They completely dominate loan agreements between museums, an important fact for large museums that want to borrow exhibitions.

The dominant text for the past quarter century in this area has been *The Museum Environment* by Garry Thomson (1978, 2nd edition 1986). It still provides an excellent overview of many issues, although some of its material is now dated.

Museum lighting guidelines

For many decades, the lighting standard in museums stated that textiles and works on paper should be illuminated at only 50 lux and paintings and other painted surfaces 150 lux. (Lux is the SI international unit of light intensity). For comparison, full sunlight can be up to 100,000 lux, indirect daylight 10,000 lux, bright spotlamps are 2 000 lux, office lighting typically aims to provide 750 lux on the desk, and a candle held an arm’s length away shines 1 lux on you.)

Several complications arose. Older viewers cannot see details at 50 lux – the usually recommended lighting level for light-sensitive textiles, watercolours and manuscripts, while even young viewers cannot see complex or dark surfaces well at that lighting level. Many artefacts are not very sensitive to light, and are kept in the dark for no good reason. On the other hand, many others are so sensitive to light that continual illumination even as low as 50 lux will cause fading after many years of permanent display. The author has reviewed all the literature on visibility, as well as all the useful data on textile fading, and developed a general lighting guideline. (Michalski, 1997)

In the last ten years, risk management has emerged in lighting guidelines from other authors. All begin with the same risk assessment approach, i.e., how soon until

noticeable fading? Different authors provide different strategies to simplify the decision across varied collections. Eventually, however, all lighting guidelines based on an acceptable time to cause noticeable fading need data on sensitivity of collections to light. The best summary of such data has appeared in a recently published international guideline for museum lighting (CIE 2004), and is presented in a shortened form in the Appendix Sensitivity of coloured materials to light.

Alternatively, one can decide to maintain the traditional rigid guideline, light all artefacts at a very low level, such as the 50 lux to 150 lux range, and accept the complications listed earlier.

Museum temperature and humidity guidelines

For several decades, the standard in humidity and temperature advice was simple, and rigid: aim to achieve 21°C with 50% RH, and very little fluctuation permitted. This standard grew out of a concern for paintings and furniture in Europe, and was indeed beneficial to those collections. Unfortunately, it was not at all beneficial to modern archival and paper materials, which needed cool and dry conditions for long life. (Michalski, 2000) It was not beneficial to corroded metals, which needed dry conditions. It was unnecessarily stringent for many collections, such as paintings, wooden artefacts, parchment, which were at serious risk only from damp and extreme dryness, or stone, ceramics, stable glass, and clean metals, which were at serious risk only from damp. Finally, as noted under sustainability, it was an expensive standard to implement at a building level.

In 1999, a committee of conservation scientists and mechanical engineers in North America agreed on a more precise set of guidelines. These were published in a new chapter for museums, libraries, and archives in the

US engineer's handbook, first in 1999, and revised in 2003. (ASHRAE, 2003) The chapter also contains an excellent review of the types of risk to museum collections, based on the subtypes of incorrect temperature and incorrect humidity given in the agents of Table 1. The recommended temperatures and humidities from the ASHRAE chapter is provided in Appendix 3. Anyone considering design specifications for a building, however, should obtain the entire chapter, for themselves and for the consulting engineers.

The ASHRAE specifications (Appendix 3) use the risk management concept. There are several grades of fluctuation control, AA,A,B,C,D, and the risks of each grade are listed in the right hand column of that table. Also listed is the risk to chemically unstable archival materials whenever temperature near 21C is chosen. Note also that when designing a temporary exhibit space to receive borrowed exhibits, the space must be designed to meet the lenders climate requirements, which are usually very strict.

In the author's experience of desert or near desert climates, the periods of sustained damp that plague maritime and tropical regions are uncommon. Rooms below ground are unusual in the traditional architecture, so continuous damp from below ground storage does not often arise. The most common hazards are very high average temperature and extreme fluctuations in temperature and relative humidity between day and night.

The risks of high temperature are actually not large for traditional materials. They are a serious problem for photographs, paper of the last 150 years, plastics, audio-visual material, and digital media. The risk is very rapid decay, unless cooling equipment is used. Thus the preservation of modern archival materials does require modern building technology.

Fortunately, metals, ceramics, glass, wood, leather, parchment, rag paper, oil paint, natural resins, and animal glue experience relatively low risk from occasional air temperatures up to 40°C. Thus traditional materials in museums and archives, such as parchment, papyrus, and rag paper, rarely are seen to have suffered loss from dry heat. When seen in poor condition, the responsible agents are almost always damp, physical forces (poor handling), insects, pollutants, UV and light. (This is not to justify outdoor exposure in desert sun. This obviously destroys these materials in a few years, due to very intense UV, and surface temperatures of 100°C or more in direct sun.)



Figure 16. Typical small museum and the ubiquitous modern air conditioners. These often cause as much harm to artefacts as comfort to visitors and staff. They often cause high RH where it never existed before, and a source of water drips (condensation) where it never existed before.

In maritime regions, i.e., near the sea or the ocean, sustained damp can become a problem. In modern European style buildings with storage below ground, and a high water table due to a river nearby, then sustained damp can also be a problem. In the author's experience,

the single most common cause of damp in small museums in hot climates is air-conditioning equipment, as in figure 16. It invariably malfunctions, and the sad fact is that air-conditioning often brings the first exposure of museum collections to high relative humidity (and another source of water leaks). Always keep artefacts sensitive to water or damp away from air conditioners. If you plan to install a new air-conditioner, monitor the rh before installing for some weeks or months if possible, and then monitor carefully after installing and operating the air-conditioner.

Humidity fluctuations pose a moderately high risk, and some examples of risk assessment were provided in the section Examples of specific risk assessments and individual solutions 6. The concept of "proofed rh" introduced in that section is critical to an estimate of risk from fluctuating rh. Note that an air-conditioner, for example, if it introduces new and larger rh fluctuations, may exceed the proofed rh of your collections.

In any situation where relative humidity is in question, human perception is generally unreliable (except for extreme damp.) Relative humidity must be measured (Detect stage) in order to make an accurate risk assessment.

Museum pollutant guidelines

Airborne pollutants are gas, liquid, or solid contaminants carried by the air that are known to cause damage to objects. Most of us are familiar with external sources such as urban pollution, desert sand, sea-spray, but museums must also consider internal sources, such as building materials and packaging materials that emit gases.

Traditional guidelines on museum pollutant specifications followed two lines of reasoning: natural levels don't appear very harmful, and, when in doubt, ask for the best available filtering systems. Thomson (1986) proposed the benchmark of naturally occurring

pollution levels, since it had been observed that archive collections far from urban areas could survive undamaged for centuries, while those in urban locations often suffered within decades. This was a useful approach for pollutants that occur naturally at some significant level, such as sulphur dioxide and ozone, but it was not useful for pollutants that occur naturally at extremely low levels. For such pollutants, there was a tendency simply to ask for “best available technology” in specifications of mechanical systems. In practice, very few museums actually built best-available systems.

Recently, Tétreault at the Canadian Conservation Institute introduced a risk management approach to pollutant guidelines, based on the concept of “observable adverse effect” (OAE). He coined the related terms No Observable Adverse Effect Level (NOAEL) and Lowest Observable Adverse Effect Dose (LOAED). These terms have been incorporated in the pollutant guidelines in the ASHRAE engineers’ handbook, (ASHRAE 2004) and are explained in detail in a comprehensive manual on pollution by Tétreault (2003). Whatever the formal terms, however, one can recognize the same risk concept as used in lighting guidelines, that of a noticeable, or observable, loss. More precisely, it is a “just noticeable” or “just observable” loss. The artefact will then continue to fade or tarnish or decay for many more doses. In the case of light fading, for example, it takes about 30 to 50 more such doses before all colour is lost. While data presented in the form of “just observable effect” is useful in setting targets, it must be used carefully in a general risk survey, because it defines the beginning, rather than the end, of a cumulative risk. Fortunately, the risk assessment scales can cope with this difference, as clarified in some of the examples earlier.

Applying pollutant guidelines becomes very complex very fast. Unlike light, which is an agent with no

subcategories, and with only one type of risk, fading, pollutants consist of dozens of particulates and gases, each with different sources, different forms of risk, different rates of damage, and different collections that are attacked. Fortunately, there is a list of the basic pollution problems which arise because either the pollutant is very widespread in its damage, such as heavy dust, or because a particular combinations of pollutants and artefact materials lead to very rapid chemical reaction. Museums have suffered from these situations over and over. Table 4 lists these.

Note that the risk reduction methods collapse into just two approaches, one for external pollutants, and one for internal pollutants. External sources are controlled primarily by the Block stage, and internal sources are controlled primarily by the Avoid stage.

Consider the problem of colorants in manuscripts. Research has shown that pollutant levels at the worst levels observed in urban situations can completely fade the most sensitive colorant in about a year, if the colorant is freely open to the polluted air. We know, however, that watercolours and manuscripts have survived very well over many centuries, even in some cities with historically heavy pollution. Why? Because of protection provided by a closed book, a sealed glass frame, closed wooden box, a closed leather pouch, even an envelope.

Scientific models show that compared to open air, a tight glass frame or a tightly closed book can reduce entry of the pollutant by a factor of 100 to 1000. In other words, the worst urban pollution hazard that brings a risk of complete colour loss in one year, is reduced to complete loss in perhaps 300 years. Thus, on the risk assessment scale, for the same urban pollution hazard, the risk drops 2-3 points on the “how soon?” scale if a tight glass frame is used. Furthermore, one can adjust all these

Table 4. The basic pollution problems (abridged from Tétreault (2003) hypersensitive materials table, plus other sources)

Pollutants	Sensitive material	Risk	Hazards, Sources	Risk reduction methods
External sources (primarily)				
Particles, especially silicates (sand) carbon (smoke)	All artefacts, especially if porous, complex surface.	Soiling. Accelerated corrosion of bright metals. Damage during subsequent cleaning.	Blowing sand, dust. Urban pollution, especially traffic.	Enclose artefacts in airtight cases, packages, cabinets. Reduce outside air entry to building, especially during peak traffic, or peak dust storms. Operate building system filters.
Ozone Nitrogen dioxide Sulphur dioxide	Some colorants in watercolours, illuminations (indigo, crimson, basic fuchsin, curcumin.)	Colour fading	Urban pollution especially traffic	
Internal sources (primarily)				
Hydrogen sulphide	Silver	Silver tarnishing, (and subsequent abrasive cleaning.)	Rubber compounds. Wool when exposed to UV. Humans.	Avoid all listed sources inside display cases. Avoid all listed sources in rooms and furnishings. Seal or coat any source used in construction.
Carboxylic acids	Lead. Carbonates, such as shells.	Lead tarnishes. Shells effloresce.	Wood and wood fibre products. Oil and alkyd paints. Water based paints while fresh.	

estimates by the benefits of closed buildings, which have been shown to lower concentrations by three to ten times below outdoor levels. The important point in all these estimates, however, is that by far the most important, most predictable, most cost-effective risk reduction was the simple glass frame. Next we see how enclosures can become the problem, not the solution.

A considerable body of conservation literature addresses the issue of safe and dangerous display materials, and how to test them, all reviewed in the text by Tétreault (2003) and in his shorter publication on

coatings (1999) A new and excellent database on the web, provided by the Center for Conservation in Quebec, Canada, describes the uses and dangers of many materials used in museum exhibits and storage. (<http://preservart.ccq.mcc.gouv.qc.ca>)

In the author's experience surveying museums in Arabic countries, the single-most common pollutant problem is not urban gases, but particulates: sand and dust, augmented often by carbon from diesel engines on buses and trucks. Commonsense tells everyone that a closed case, closed cabinet, closed envelope, box, whatever, reduces the risk of

this hazard. In figures 8, 15, artefacts in cases are successfully protected from dust, from any source. Museums exhibit designers, however, often want open display, or the museum simply lacks the resources to enclose large objects. The daily cleaning of the museum then leads to other problems outlined earlier in the section on house-keeping, and illustrated in figure 7.

Integrating management of all four agents

These four agents, pollutants, light/UV, incorrect temperature, and incorrect humidity, have many features in common, each of which suggests paths for integration.

- A All four are “scientific” agents of deterioration, the ones of modern knowledge. The preceding five agents (#1 to #5) are ancient in their understanding.
- B All four can be measured precisely by scientific instruments, or meters. In fact, unlike the preceding five ancient agents, their intensity is not easily estimated except by instruments.
- C All four are strongly associated with engineering and design of the building, and of exhibits and storage fittings.
- D All but light/UV move towards the artefact by air movement.
- E All but incorrect temperature can be blocked by thin, low-cost, even delicate materials.

Implications of A and B. The fact that these agents are scientific, and that they can be measured, has been a double edged sword in museum integration. On the one hand, modern conservators and scientists were comfortable with scientific agents, learned how to measure them, and had integrated them into a single practical concept: “the museum environment.” Museums accumulated a great deal of environmental data, and even curators became familiar with light

meters and thermohygrographs. On the other hand, conservators and their scientists tended to lose sight of the more ordinary, unscientific hazards, such as poor handling, pests, water, even dirt.

The museum should have access to a light meter, UV meter, humidity meter, and thermometer. Many countries have discovered the advantage of using a central regional or national agency that lends these instruments as a kit to smaller museums who don't have the resources to purchase or calibrate them. Pollutant measurement is more complex. Some important indoor museum pollutants can be measured using simple colour dosimeters. External pollutants are usually measured by other agencies, and the information can be obtained from them. An excellent review of the possibilities of pollutant measurement is in Tétreault (2003).

Implications of C and D: Integrated control of museum climate and lighting will require mutual understanding between designers of the all building systems and all exhibition and storage systems.

Implications of E: Many risk reduction solutions to contaminants, UV, light, and incorrect humidity require little more than an opaque bag of clean material. Hence one of the basic strategies listed in the List of Basic Strategies earlier.

Conclusions: Keep going

The intent of this chapter has been to teach an attitude and a skill that can lead to effective collection preservation. It could not review all the necessary information, only draw on useful examples. The professions of conservator/restorer, and of conservation scientist, however, are well served by a body of technical literature, easily located through publications, and increasingly, well served by the web (see the references at the end of the chapter).



Figure 17. Teamwork and training. Young conservators and conservation scientists during a training exercise in a museum. They are learning the use of light meters and humidity meters, and some basic elements of a collection survey. The case in front of them holds a pile of bronze coins, fused together in a corroded mass with sand, and displayed to show how such hoards are found by archaeologists.

What has struck the author repeatedly, throughout the world of museums, is that in spite of great good will on the part of staff, a remarkable fragmentation and inconsistency in preservation strategies is the common. Long-term effective preservation depends on risk management, on integrated methods, on teamwork, and on sustainability. Those responsible for preservation of collections must understand these ideas, and gradually convince others in the museum, before they can achieve them.

Figure 17 is a fitting place to end this chapter. It shows a group of young conservators and conservation scientists in Egypt, on a training exercise five years ago. They are learning the use of environmental monitors, such as light meters, and the basics of surveying an exhibition building for this particular agent. It is a bridge between their normal work, which involved no

surveying at all, and a possible future task for some of them, of leading a complex survey of all risks to the collection. The exhibit case they are all resting on while they discuss and share light readings contains a coin hoard, placed in the case by the designer to show how archaeologists discovered them. It is a cemented mass of corroded bronze and dirt, showing the classic pale green colour of contaminated and actively corroding bronze, resting in a case perched on one leg. Exercise: What are the risks? How significant are they? How can you find out? What would you advise the museum? We need the report next week...

Appendices

Appendix 1. The visible facts: A suggested survey path, basic set of observations, and set of photographs

General comments: Although the photo sequence will help organise photos, it is essential to record the photo number alongside any notes about observations, and to note in observations which room, which door, which collection, etc.

Although the ultimate purpose of a risk assessment survey is to discover the risks to a collection, remember that the survey is only a first phase in collecting facts that will be used to estimate significant risks to the collections. Of course, during a survey one will see and understand many risks, and this will help in collecting the most useful observations, but make observations even if the door or wall or packaging is “good”. In any systematic survey, such as this one, or Waller’s (2003) one makes estimates about all agents and all collections, so that the report describes both the good and bad aspects of current risk management of the collections. Diplomatically, most museums like a report with some positive observations!

Site

Walk: Around the whole site, 10m to 50 m away from the building

Photos: Overall views (wide angle) of site from front of building, from left side, back, right side.

Observations to collect:

Type of buildings nearby, or attached? (source of fire, water, thieves, vandals)

Slope of the land nearby, the height/distance to nearby rivers and drains? (water)

What public water and drainage and sewage systems can you see? Do they appear in good condition? (water)

Fire hydrants available nearby? (fire)

Lighting for night surveillance? (thieves, vandals)

Building Perimeter

Walk: Around the building perimeter, looking at the walls and roof (If necessary, later get access to a view of the roof)

Photos: Overall views (wide angle) of front, right side, back, left side, of the building.

Observations to collect:

Wall materials, gaps, quality of construction? Cracks? Gaps? (block all agents of deterioration)

Wall vents? Do they have screens? (block pests, thieves)

Night lighting? Clear lines of sight? (thieves, vandals)

Perimeter near building clear of vegetation. Garbage stored nearby? (pests)

Roof construction? Sloped or flat? Type of drain system? Condition? Signs of failure? (water)

Any other obvious hazards related to the building perimeter?

Doors and windows

Walk: Around the building perimeter, looking at the doors and windows (If necessary, later get access to the inside view of each door and window)

Photos: Identify each different type of door. Make at least one photo of each type. Any doors with special

problems, make a photo. Take close-ups of locks, gaps, any problems of poor condition (always take these in sequence with the overall photo of that door/window.)

Observations to collect:

Door materials, locks, hinges, gaps, seals, quality of construction? (ability to block all agents)

Window materials, locks, gaps, seals, screens, quality of construction? (ability to block all agents)

Screens, curtains, blinds? (thieves, vandals, light, UV)

Where they open at the time? Why? (ask staff)

Any other obvious hazards related to the doors and windows?

Non-collection rooms

Walk: Through all rooms and halls without any collections

Photos: Wide angle view of each room, one towards door, one opposite. Close-up of any relevant observations.

Observations to collect:

Loading bays: type and height of access ramps (risk of dropped artefacts)

Quarantine rooms: use, access (pests)

Janitors rooms, washrooms: sinks, plumbing, overflow drains (water)

Food preparation and service rooms: as above, plus garbage, cleanliness (pests)

Hallways, elevators: ease of access, obstructions, cleanliness (physical forces in transit, pests)

Collection Rooms

Walk: Through each room with collections. Display first, in visitor's sequence, then storage. Within each room, walk around the perimeter several times, looking carefully, before making photos or notes. Finish all rooms before surveying fittings or collections.

Photos: Wide-angle of each of 4 directions, each taken from as far away as possible. First wall with door, then

proceed clockwise. If the wall photos do not show all the ceiling and floor, take separate photos of the ceiling and floor. For each significant observation below, where a particular risk is identified, take a close-up.

Observations to collect:

What floor (i.e., height above ground) is this? (water risk from flooding)

What fire systems visible (sprinklers, portable, detectors)?

Special mechanical systems? (pollutant, temperature, rh, control, water)

Plumbing visible overhead, on walls, near floor? (water)

Floor drains, placement, stop-valve, condition? (water, draining, and backup)

Electric lighting systems, lamps types, lux levels average, maximum?

Which doors and windows from the building survey are used in this room? (ability to block all agents)

What wall materials, gaps, quality of construction? (ability to block all agents)

Any other obvious hazards related to the room?

Fittings

Walk: In each room, identify the various types of fittings (cabinets, cases, shelving, barriers for visitors). Make a note of the number of each type, and how many are in each room. It is not necessary to segregate similar fittings, unless the difference has a significance to risk.

Photos: At least one overall photo of each type of fitting, and some close-ups of construction, locks, gaps, any examples of damage, or other risk issues.

Observations to collect:

Materials of construction, of glazing? (ability to block agents, source of contaminants)

Quality and condition, gaps? (ability to block agents)

Security features, locks?

Ability to shed water?

Stability against toppling, collapse? (physical forces, vandalism)

Lighting fixtures, lamp type, lux levels, UV filters, quality and condition? (UV, light, incorrect temperature and rh, fire)

Any special control features for humidity, pollutants?

Any other obvious hazards related to the fitting?

Collections, supports, and packaging

Walk: By now in the survey, the collections will have been observed several times while surveying the rooms and fittings. It is a time to reflect on how to survey the collections, their supports, and their packaging. The purpose of this collection survey is not to capture a detailed view of each artefact. That is one of the purposes of a good catalogue. The purpose is to discover the current pattern of risks. Some observations can apply to all the collections, some observations can apply to one special artefact, but only if it is very important.

Photos: Photos will now be associated with each observation.

Observations to collect:

Type of supports, materials, quality, on how much of the collection ? (physical forces, contaminants)

Type of packaging, materials, supports, on how much of the collection? (ability to block many agents, source of contaminants)

Finally, very important: What portions of the collections are in what nested sequences of building, room, fitting, support, and packaging (or partial sequence, or on the floor, or outside, etc.? This will lead to the identification and estimates of risk, and to recommendations for improvements, in combination with invisible facts of Appendix 2. Remember, this survey pattern collects facts systematically, both positive and negative, which then lead to risk assessments, low

and high. One can choose instead, as do many experienced surveyors, to only collect observations that lead to estimates of significant risks. Better to report the positive survey observations without a risk estimate (e.g., food garbage is removed daily to a location 30m from the building) even if there is a related significant risk elsewhere in the report (over a 2 week test, large numbers of insects were collected in sticky traps in the collection rooms, and these showed a clear increase at the wall nearest the food service area. Fortunately none are clothes moths, but a high probability of a clothes moth infestation in the open textile collections is indicated within a few years.)

Appendix 2: Basic list of invisible facts needed, and their sources

Staff interviews

What damage has occurred in the past to the collections?
What were the circumstances?

For staff members inside and outside conservation, what are their formal roles and responsibilities in collection preservation? What are their opinions and understandings of the practical realities?

Documents

What are the policies and procedures of the museum, especially related to the collections?

What reports exist of prior risks, events, planning reports?

Building, facilities, exhibits construction?

External data

External hazards, probabilities?

Answers to all the questions needed to complete the various risk estimates?

Appendix 3. Temperature and relative humidity specifications

Compiled by Michalski, S. Canadian Conservation Institute for use in the ASHRAE handbook, first published 1999, and later 2004 (ASHRAE 2004).

COLLECTION TYPE	SETPOINT OR ANNUAL AVERAGE	MAXIMUM FLUCTUATIONS AND GRADIENTS IN CONTROLLED SPACES			COLLECTION RISKS/BENEFITS
		Class of control	Short* fluctuations plus space gradients	Seasonal adjustments in system setpoint	
GENERAL MUSEUMS, ART GALLERIES LIBRARIES AND ARCHIVES: all reading and retrieval rooms, rooms for storage of chemically stable collections, especially if mechanically medium to high vulnerability.	50%RH (or historic annual average for permanent collections) T: A value between 15°C and 25°C (Note that rooms intended for loan exhibitions must be capable of the setpoint specified in any loan agreement, typically 50%RH, 21°C, but sometimes 55%RH or 60%RH).	AA Precision control, no seasonal changes	±5%RH ±2°C	RH: no change up 5°C; down 5°C	No risk of mechanical damage to most artefacts and paintings. Some metals and minerals may degrade if 50%RH exceeds a critical RH. Chemically unstable objects unusable within decades.
		A Precision control, some gradients or seasonal changes, not both	±5%RH ±2°C	up 10%RH, down 10%RH up 5°C; down 10°C	Small risk of mechanical damage to high vulnerability artefacts, no mechanical risk to most artefacts, paintings, photographs, and books. Chemically unstable objects unusable within decades.
			±10%RH ±2°C	RH: no change up 5°C; down 10°C	
		B Precision control, some gradients plus winter temp. setback	±10%RH ±5°C	up 10%, down 10%RH up 10°C, but not above 30°C down as low as necessary to maintain RH control	Moderate risk of mechanical damage to high vulnerability artefacts, tiny risk to most paintings, most photographs, some artefacts, some books and no risk to many artefacts and most books. Chemically unstable objects unusable within decades, less if routinely at 30°C, but cold winter periods will double life.
		C Prevent all high risk extremes.	Within range 25%RH to 75%RH year-round T rarely over 30°C, usually below 25°C		High risk of mechanical damage to high vulnerability artefacts, moderate risk to most paintings, most photographs, some artefacts, some books and tiny risk to many artefacts and most books. Chemically unstable objects unusable within decades, less if routinely at 30°C, but cold winter periods will double life.
D Prevent damp.	Reliably below 75%RH		High risk of sudden or cumulative mechanical damage to most artefacts and paintings due to low humidity fracture, but high humidity delamination and deformations, especially in veneers, paintings, paper and photographs will be avoided. Mould growth and rapid corrosion avoided. Chemically unstable objects unusable within decades, less if routinely at 30°C, but cold winter periods will double life.		
ARCHIVES LIBRARIES Storage of chemically unstable collections	Cold Store: -20°C 40%RH	±10%RH ±2°C		Chemically unstable objects usable for millennia. RH fluctuations under one month do not affect most properly packaged records at these temperatures. (Time out of storage becomes the lifetime determinant).	
	Cool Store: 10°C 30%RH to 50%RH	(even if achieved only during winter setback, this is a net advantage to such collections, as long as damp is not incurred)		Chemically unstable objects usable for a century or more. Such books and papers tend to low mechanical vulnerability to fluctuations.	
SPECIAL METAL COLLECTIONS	Dry room 0-30%RH	RH not to exceed some critical value, typically 30%RH			

* Short fluctuations means any fluctuation less than the seasonal adjustment. As noted in the text under "Response times", however, some fluctuations are too short to affect some artefacts, or enclosed artefacts.

Appendix 4. Sensitivity of coloured materials to light

This is an abbreviated version of the table compiled 1999 by Michalski, S. at the Canadian Conservation Institute, and published in CIE. (2004) For more detailed lists of colorants under each category, see the CIE table. For textile dyes alone, see the table in Michalski (1997.)

	High sensitivity to light			Medium sensitivity to light			Low sensitivity to light			No sensitivity to light ^f		
	<p>Most plant extracts, hence most historic bright dyes and lake pigments in all media:⁹ yellows, oranges, greens, purples, many reds, blues.</p> <p>Insect extracts, such as lac (yellow), cochineal (carmine) in all media.⁹</p> <p>Most early synthetic colours such as the anilines, all media.</p> <p>Many cheap synthetic colorants in all media.⁹</p> <p>Most felt tip pens including blacks.</p> <p>Most dyes used for tinting paper in this century.</p> <p>Most photo colour prints with "color" in the name. e.g. Kodacolor</p>			<p>A few historic plant extracts, particularly alizarin (madder red) as a dye on wool or as a lake pigment in all media. ⁹ It varies throughout the range of medium and can reach into the low category, depending on concentration, substrate, and mordant.</p> <p>The colour of most furs and feathers.</p> <p>Most photo colour prints with "chrome" in the name, e.g. Cibachrome.</p>			<p>Artists palettes classified as "permanent" (a mix of truly permanent AND low light sensitivity paints , e.g. ASTM D4303 Category I; Winsor and Newton AA.)</p> <p>Structural colours in insects (if UV blocked).</p> <p>A few historic plant extracts, especially indigo on wool.</p> <p>Silver/gelatine black and white prints, not RC paper, and only if all UV blocked.</p> <p>Many high quality modern pigments developed for exterior use, automobiles.</p> <p>Vermilion (blackens due to light)</p>			<p>Most but not all mineral pigments.</p> <p>The "true fresco" palette, a coincidence with the need for stability in alkali.</p> <p>The colours of true glass enamels, ceramics (not to be confused with enamel paints).</p> <p>Many monochrome images on paper, such as carbon inks, <i>but the tint of the paper and added tint to the carbon ink are often high sensitivity, and paper itself must be cautiously considered low sensitivity.</i></p> <p>Many high quality modern pigments developed for exterior use, automobiles.</p>		
Blue Wool categories	1	2	3	4	5	6	7	8	Over 8			
Mlx h ^a for noticeable fade ^b UV present ^c	0.22	0.6	1.5	3.5	8	20	50	120				
Probable Mlx h ^a for noticeable fade ^b if no UV ^d	0.3	1	3	10	30	100	300	1000				

Explanatory notes to table:

The "Blue Wool categories" are the international standard (ISO) categories for specifying sensitivity to light, based on 8 blue dyes on wool, used as reference samples in most lightfastness tests.

a. Mlx h is the unit of light exposure, or dose. Megalux hours. It is light intensity (lux) multiplied by exposure time (hours)

b. A noticeable fade is defined here as Grey Scale 4 (GS4) , the step used in most lightfastness tests as noticeable. It is approximately equal to a colour difference of 1.6 CIELAB units. There are approximately thirty such steps in the transition from a bright colour to almost white.

c. UV rich refers to a spectrum similar to daylight through glass. This is the spectrum generally used for the lightfastness data used to derive this table. The exposures here are the best fit to data that varies about one Blue Wool step.

d. Exposures estimated for UV blocked light source are derived from a study on 400 dyes and the blue wool standards themselves. As such, it is only probable, and probably only for organic colorants. These estimates show minor benefit of UV filtration for low sensitivity colorants, but large improvements for high sensitivity colorants. For conservative estimates, use the UV rich scale.

f. "No sensitivity" to light does not mean guaranteed colour life. Many colorants in this group are sensitive to pollution. Many organic media will chalk or yellow or both if any UV is present.

g. The particular paint medium makes only small differences to fading rate, it is the colorant that matters in fading, not whether it is oil, or tempera, or watercolour, or acrylic. Media does, however, make large differences to rate of discoloration from pollutants such as ozone and hydrogen sulphide.

Display, Exhibits and Exhibitions

Yani Herreman

School of Architecture, National University of Mexico

Most people who go to museums do so with the idea of visiting the exhibition halls, and will even try to see all of them in a single visit, which is certainly not advisable. Concentrating on just one particular gallery or even a very specific object in a single visit can often be much more enjoyable and satisfying.

The public displays and exhibitions are by far the most popular parts of most museums. It is here that a direct contact between the visitor and the museum's collections takes place. It is here where any individual, regardless of age, social and economic status, alone or as part of a group, has the opportunity and space to see the "real object", and with the help of certain exhibition techniques to communicate or interact with it. Belcher (1991) has very perceptively written that "Only exhibition provides a controlled contact with the real, authentic object, and this is what makes museum exhibitions so vitally important".

There are several definitions of the words display, exhibit and exhibition. One leading dictionary, the Webster Comprehensive Dictionary of the English Language, defines display as "to show, to make apparent to the eye or the mind", exhibition as "showing of works of art" while exhibit is described as "to present to view, to display". Definitions of the three terms vary according to country and language: in Spanish all three are synonyms, while in French and English they have slight or definitive different meanings. There are also subtle differences in definition and usage between North American English and that of Britain and most other Anglophone countries.

Some leading specialist exhibition designers and museologists have offered more detailed definitions, including, for example: "An exhibition is a means of communication aiming at large groups of the public with the purpose of conveying information, ideas and emotions relating to the material evidence of man and his surroundings with the aid of chiefly visual and dimensional methods" (Verhaar and Meeter, 1989).

To a leading museologist (Burcaw, 1997) display is "the showing of objects, depending on the interest of the viewer in the objects themselves", exhibit is defined as "a more serious, important, and professional connotation than display. It is the presentation of ideas with the intent of educating the viewer, or, in the case of an art exhibit, a planned presentation of art objects by an informed person to constitute a unit", while he defines exhibition as "an assemblage of objects of artistic, historical, scientific or technological nature, through which visitors move from unit to unit in sequence designed to be meaningful instructionally and/or aesthetically".

My own definition (Herreman, *in press*). is "An exhibition is a communication medium based on objects and their complementary elements, presented in a predetermined space, that uses special interpretation techniques and learning sequences that aim at the transmission and communication of concepts, values and /or knowledge".

Types of displays

Exhibitions are classified according to different criteria. Belcher (1997) gives several approaches to exhibition types and discusses among other things the much used term “permanent exhibition”, saying: “Permanent”, meaning long term as opposed to “temporary”. As he correctly adds, both terms are relative, since permanent exhibitions are now extensively modified and/or periodically exchange their displayed objects. This type of exhibition is expected to last from ten to fifteen years.

In my forthcoming study (Herreman, *in press*), I propose redefining what used to be called “permanent exhibitions”. Since these are planned as part of a core concept structure, storyline or discourse within a museum, it would be better to call these “core” exhibitions. From a design point of view this type of exhibitions should use approaches that will not tire the visitor, that will not quickly look old-fashioned, and should use materials that will endure time.

In fact, nowadays there are a number of mainly smaller sized museums that do not have or aim to have “permanent” exhibitions, but instead take the opportunity to present different themes and collections using longer-term exhibitions that may last perhaps one to three years, as with the Museum of Popular Cultures in Mexico City. Others, such as the (very large) Musée de la Civilisation, in Quebec City, has a very small core exhibition while the main galleries are dedicated to themed exhibitions lasting from a few months to a year or two.

As for what a “temporary” exhibition means, Belcher divides these into “short term”, that last from one to three months, “medium term”: three to six months; and “long-term” which are expected to last for an indefinite period. Medium term or longer-term exhibitions can be very successful. They do not have the constraint of

needing to follow the museum’s overall display policy and storyline, and they offer visitors the chance to see something new within a specific time span. In terms of design, they may use more contemporary and innovative materials and presentation systems, indulge in more attractive and fashionable solutions, but without diminishing the object.

Other common modes include travelling exhibitions that may be as simple as a single object or group of objects through to “blockbusters” costing millions of dollars to research, assemble and tour. This very wide category also includes exhibitions that are designed and circulated in buses, trucks or trains. These may be one-off projects or a complete national system as with the famous Swedish Rijskuntallningar the national travelling exhibition service, which takes exhibitions of all sizes to many locations throughout the country.

In general, travelling exhibitions aim to offer the opportunity to see them to a greater and more diverse population, in different locations. Because of its nature, the design of the travelling exhibition needs to take several issues into account, including the need for flexibility in terms of layout, etc., so that it can be fitted into different sizes and shapes of exhibition gallery, and ease of erection, maintenance and mounting and dismounting, as well as ease of transportation between venues.

“Blockbuster” exhibitions touring to perhaps three or four different institutions (each of which contribute to the cost) have become very fashionable since some pioneering examples such as “Tutankahmen” and “The Horses of San Marco, Venice” in the 1970s, and are now characteristic of a globalised world. Most large museums have organised and received this type of exhibition that attract enormous numbers of visitors, frequently offering them a unique opportunity to see rare and precious objects, or a new perspective on the subject in focus.

Obviously, these exhibitions have special design, management, legal and conservation and security requirements and problems which makes them very expensive.

The object: interpretation within the exhibition context

When we stand before a showcase and look at the objects inside it, they will impact on us in different ways. They may arouse interest, attract or repulse us, please us, or make us want to know more about what is shown. These responses vary from individual to individual and are influenced by emotional and external situations. The psychological and perceptual explanations of the exhibition process are now being studied by researchers in a number of fields, including psychology, education and communication science.

But objects do not communicate by themselves. They need the interpretative support that curators, educators and designers give them. By these means a far larger group of people, most of whom will probably not be specialists in the subject, will be able to understand and appreciate them. The museum object is normally considered as a unique piece that represents many different things, not necessarily beauty, but also history, memory, identity or scientific information among other things, to a person or group of persons. An object by itself may not be significant but its context or history may make it so. Putting this on exhibition helps disseminate knowledge about the subject, collection and individual objects, helping the general public or the specialist visitor to understand and respect it more.

In the exhibition context interpretation means the group of actions and elements that help explain the content of the exhibition. Curators who carry out the necessary research for an exhibition and the designer

who interprets and communicates this interpret the group of objects and the knowledge and information that they represent for the benefit of a larger audience. The way that this is achieved and how real objects convey meanings or become significant to their audience is part of communication, and the techniques of modern communication science including semiotics and psychology are now applied as part of a design process. We know that an object has different meanings according to the context in which it is located, its relations with other objects, the position where it is displayed, the colours that surround it and even the labels that are used.

Exhibition management in relation to other museum activities

Planning, designing and producing an exhibition, either a complete gallery or one individual showcase, depends on effective teamwork. What we see when we enter an exhibition gallery of a museum is the end product of a long chain of linked organised processes and activities carried out sometimes in sequence and sometimes simultaneously.

Exhibitions must be managed in the same way as any other activity within the museum. Thorough planning, scheduling and budgeting are nowadays as important a part of exhibition work as designing the exhibition itself; good management and the effective use of resources (including staff) facilitates rather than inhibits good exhibition design. However, because of the complexity of these different tasks it is not surprising that a new specialism of “Exhibition Project Manager” has appeared recently as the person who is in charge of coordinating the whole exhibition development and production process and facilitating a constant dialogue between the different parties involved.

Who is or should be the Exhibition Project Manager?

The size of the museum and, in particular, the number and availability of staff and their specialisms affects this. If the museum has the necessary professional and managerial expertise in-house, either the curator or the designer might also act as Exhibition Project Manager, while in a small museum, the Director will, almost certainly, also take on this responsibility. However, in many museums, particularly those in developed countries, exhibitions are frequently developed, managed and implemented by either individual freelance qualified specialist designers or specialised design companies working under contract, in which case the museum will usually nominate an appropriate member of the staff to act as a contact person to work with the “outside” planning and design team.

If there is an activity within a museum that is truly interdisciplinary, it is exhibition design. The designer, must work closely with the curator, the conservator, the administrator and the educator as well as with the electrician, carpenter, mason, and as many other specialists as are needed, according to the type of exhibition. In particular there will need to be close links with public relations staff and with the security and building maintenance personnel, for the publicity, and the security and maintenance aspects respectively.

Design: the basic planning and designing process

As stressed previously, the making of an exhibition is a complex process. This section aims to describe in a clear and simple way, the main management and development steps in creating a good display or exhibition. These processes are basically the same regardless of size or subject (see Box 1, and the commentary that follows). However, the details will vary according to the museum’s

staff and other resources and the specialist staff available to participate.

The five stages in the design process

1. Planning
2. Research/Interpretation
3. Design
4. Production
5. Installation

Planning

Planning has been heavily researched and analysed by academics, managers and designers. It has adopted methods and systems from other disciplines, particularly architecture, industrial process management and computer programming. Planners and designers may have different approaches to exhibition development but agree on the core stages that are listed below. Exhibition planning can be defined as the activities that will help (a) determine the aims and feasibility of the desired project, (b) organise the exhibition process taking into account available human, technical and economic resources as well as timelines and cost estimates.

Objectives of the display or exhibition

This first issue is of the highest importance since it will guide all aspects of the exhibition. The “whole design” concept focuses on what we want to achieve with the exhibition. For example: do we want to enhance the aesthetic features of the objects in the exhibition? Do we want to assess and communicate their scientific or historical importance? In the first case, our goal is to deliver an aesthetic and enjoyable experience to the audience, whereas in the second, the aim is a more educational one.

Target audience

Knowing the audience is something that modern museum practice considers absolutely basic in relation to almost any kind of museum activity, and especially so in relation to displays and exhibitions. These are the public spaces where audiences come into contact with the objects and the concepts or information that these represent or illustrate. In addition to the necessary understanding of the museum's community, when developing an exhibition project it is also advisable to identify the target group or groups in relation to relevant factors, taking into account the fact that any audience is made up of many and varied types of individuals, with differences in ages, levels of education, tastes and interests. Obviously, a museum aims to serve as wide a cross-section of the local population and other potential visitors as possible. However, it will probably not be possible to satisfy equally all the different interest groups within an audience.

The responsive museum must therefore decide on, for example, the expected reading and other communication levels, and the degree to which the visitor may have prior knowledge of the subject. For example, though most of the time a "general" museum will want exhibitions designed for what is usually called the "general public" – probably adults with the average level of education and literacy for that country or town, in other cases they may want to give special attention to poorly educated adult individuals, perhaps using very short and clear labels with drawn or other visual explanations. This may well be the case in many developing countries, and the exhibitions produced would probably be also suitable for schoolchildren between the ages of perhaps 9 and 13. On the other hand, a university museum planning a teaching exhibition for specialist students in the subject would design the displays at a very different level, which

would take into account the expected prior knowledge and abilities of that very different target audience. Knowledge of the audience also enables the designer to plan the necessary circulation spaces and clearances, as well as rest spaces.

Feasibility

Exhibitions, as any other museum programme, must undergo a thorough study of the possibilities before the final policy decisions are taken.

Factors to be assessed and taken into account in an exhibition feasibility study:

- 1 The objects to be displayed: availability, conservation and security issues.
- 2 The space available: size; access possibilities, including during installation and for disabled visitors when the exhibition is open.
- 3 Available staff resources: in-house staff, outside contractor or consultant, or a combination of the two.
- 4 Timing: within the museum's overall programme of exhibitions, events and other activities, time requirements for planning and installing.
- 5 Cost: estimated project budget required, including construction, transport, publicity, maintenance and dismantling.
- 6 Who should be the core exhibition team, and how this should be organised.

Exhibitions are the material outcome of a combination of many diverse skills, and much knowledge, expertise and experience, coupled with taste and even sensibility. The participation of different specialists will be necessary to achieve this, but not necessarily from the beginning.

It is advisable to start the planning activity with a basic or core working team that will include the specialist curator or curators, the designer, the conservator and the education officer. Within this small group, a coordinator will be assigned as Exhibition Project Manager. In this initial stage, tasks will be assigned to each member according to their expertise.

Likely make-up of the exhibition project team,
(what designers call the “exhibition team”, “exhibition committee” or “work group”)

This is likely to include some or all of the following categories of staff (or outside consultants), depending on the size and nature of the proposed exhibition or new display:

Administrative	Professional	Technicians	Craftspeople
Board members	curator(s)	photographer	preparators
director	conservator	lighting engineer	electricians
project manager	designer(s)	sound engineer	mounting team, etc.
	education specialist		security engineer

Probably only very large museums with a heavy exhibition programme and big enough budget to carry it out will have so many specialists in-house. But even if this is the case, many institutions nowadays prefer to work jointly with an outside contractor. In a medium to small size museum most of the projects may well be contracted out. In this case a number of suitably qualified and experienced design and exhibition contractors submit a Proposal document with an outline approach, a sketch design, costings and a proposed timetable for the different elements of the job, and the contractor’s proposed fee for the design and exhibition management. If the project is to

be carried out by an in-house Design and Exhibition Department it is just as necessary that similar plans and costings are produced at the planning stage.

It is important that in either case the budgets include realistic estimates of not just the money required, but also the human, material and time resources that will be required. After the project and method of working have been chosen, the in-house exhibition team will act as a steering committee, while the Exhibition Project Manager becomes the contact person between the core group and the in-house or contractor’s full team.

In the case of a very small community or site museum where there is no possibility of developing or constructing our exhibitions with permanent or in-house specialists such as a conservator, an educator and a designer, the Director, who will most probably be a curator, may take on the role of the Project Manager. It may well be that such a museum may seek the support of another, larger institution, be it a museum or a university to help with curatorship, design and construction.

Another important element of planning is to estimate the time required for each exhibition design stage and to coordinate each with other parts of the project. Time charts and network diagrams are generally regarded as the most suitable tools for this.

The aim of the planning team should be to produce a written document (the Planning or Exhibition Brief) which sets out the exhibition’s objectives and goals, concept, target audience, working team and method of working, feasibility study results, description of the planning process, timing and a draft budget.

Developing the Exhibition

Once an exhibition brief has been agreed, appropriate members of the team move on to developing the details of the concept, particularly the proposed objects, data and

Creating the Planning Brief.

The Planning Brief for a display or exhibition aims to help the exhibition process by clarifying goals, the exhibition concept, time schedules and the human and financial resources needed. It is also most useful in presenting the project before decision makers, patrons or Boards and is also a basic tool for fund raising.

Typically the following will need to contribute to the development of the planning brief, and all subsequent stages in the exhibition process:

- 1 Decision makers, particularly the director and Board or Ministry: for official approval and general administrative support
- 2 The project manager or general coordinator: coordinates the initial process and acts as a link person between different specialists
- 3 Specialist Curators for the subject area: research and determine the concept and are the main people responsible for the content of the exhibition brief
- 4 Conservator: advises on general and special conservation requirements
- 5 Designer: advises on general design and interpretation solutions and on the effective use of space
- 6 Education specialist: advises on general educational aspects, such as relating the displays to the school curriculum, and communication matters, such as readability in relation to literacy level
- 7 Buildings and Security staff: advise on all aspects of the use of the building including such issues as safe floor loadings, access for equipment and contractors, as well as the safety, access and security aspects of the project
- 8 Administrative or Finance staff: help to prepare a first estimate of costs and labour and monitors the budget throughout the whole process, also contract and purchasing details for all works and supplies, including equipment, materials, outside contractors, freelance or consultant and temporary staff

information that will be presented in an exhibition. This will probably involve some special research by curators to update knowledge of and the interpretation of the collections and themes to be included. At the same time the design, education specialists, and perhaps marketing staff also, may need to undertake research into the actual and potential audience and different approaches to interpretation and communication.

Typical responsibilities of the curator in relation to exhibition development

Primarily the curator's duties are to:

- 1 Establish concept
- 2 Develop thematic and scientific script
- 3 Select objects or works of art and illustrations
- 4 Carry out or supervise necessary documentation
- 5 Write information panels and label content, and other written information
- 6 Advise designer in developing design storyboard
- 7 Advise designer in developing graphic system design
- 8 Supervise development of graphics
- 9 Supervise construction of support materials
- 10 Supervise installation or mounting of exhibition
- 11 Write the catalogue or guide

However, this needs to be a team effort, and it is advisable that the following team members should also participate with the curator(s): specialist external advisors on thematic issues, an interpretation expert, a documentalist, a conservator, and a museum educator. The designers may be invited but may not participate so actively at this early stage.

Approaches to story or theme development may differ. Some specialists prefer a more descriptive method while others, including myself, favour a system borrowed from film-making. Using this model, the aim is to develop the "script" (the term often preferred by curators) or "storyboard" (the term usually preferred by designers as it may include sketches and other visual indicators as well as the text).

Whatever the name given to it, this aims to be a comprehensive document that lists, in strict sequence, the different sections of the exhibition; themes and sub-themes are classified and arranged hierarchically. It includes details of objects or artifacts to be used, graphic material, and all supporting elements such as dioramas,

models, replicas and hands-on units. In the Design Storyboard every physical component of the exhibition is given a code that will serve as its identification throughout the fabrication and installation processes. There may be a more complex version of the storyboard that adds a description of educational and communication objectives.

Exhibition systems

Many big and well-financed museums have flexible standardised, often modular, exhibition and display systems including showcases, movable walls and display screens and panels which allow multiple use and in different ways. Such museums are likely to design and build much of both their long-term (“permanent”) displays and temporary exhibitions around such a system, using the available display elements and modular prefabricated cases.

On the other hand, for special occasions or particular requirements, specially designed and constructed exhibition designed systems and furniture may be needed or desired. These may be produced in-house or be contracted out. Small museums may find it easier to have their basic exhibition cases made in-house or by local contractors though, with a view to their eventual re-use in other displays or exhibitions. If designed correctly, there is no reason why these cannot be used several times over. The other basic design goal is to find the right balance between objects and their designed setting, which should never be more prominent than the objects themselves.

It is extremely important to underline consideration of three vital elements in the design process. The first is the importance of preventive conservation. The specialist conservator’s presence during the whole designing process, closely advising the designers and preparators, is essential for a truly successful exhibition. Second, we can never

overestimate security and conservation requirements for objects on display and while being handled in transit to the display, whether this is just a few metres from the museum storage to the display case, or half way round the world in the case of an important object borrowed for a major temporary exhibition. The third is the need to take into account future exhibition maintenance when preparing the design, remembering that circulation and resting areas have to be cleaned as well as the showcases. The way in which these everyday routines can be carried out should be one of the designer’s determinants, since keeping an exhibition area clean is a basic requirement to achieve satisfactory conservation and safety standards.

The Design Process

Using the storyboard as a guide, the designer should then proceed to:

- 1 evaluate and allocate exhibition space according to storyboard themes and other visual and communication needs
- 2 determine circulation space needed, including disabled access requirements, security needs and official legal norms such as fire escapes
- 3 examine and distribute objects by units, sections, subsections that correspond to themes and sub-themes in the script and storyboard
- 4 consult the conservator or curator on every collection-related issue
- 5 consult education specialists for information level and educational structure of the storyline
- 6 design the exhibition furniture system: panels, free standing exhibit showcases, screens, case shelves, block cases, table cases, wall hung panels and other wall mounted elements.
- 7 design the graphic and printed system; determine the colour scheme, distribution and placement.
- 8 design lighting systems. Consult with specialist and conservator
- 9 design sound systems. Consult with specialist and education specialist
- 10 design other special installations (if needed). Consult with specialist and conservator.

Production and Materials

It is the manufacturing or fabrication processes of the different elements that in the end create an exhibition. These can be divided into building work and specialised production. The first covers such activities as masonry and brickwork, plasterwork, basic electrical, video and audio installation, wiring and fixed furniture manufacturing, while the second includes more specialised work such as graphics, reconstructions, model-making, artwork, etc.

Main elements of Production Work

Building works

- 1 Spaces. Walls, partitions or ceilings, if required by the storyboard, within the assigned exhibition area.
- 2 Physical preparation of exhibition space: plaster work, painting, electrical installation. Conservation counsel is advised
- 3 Carpentry and plastics
- 4 Furniture and any supporting element.
- 5 Glass and acrylic elements for showcases.

Specialised work

- 6 Graphics: charts, maps, drawings, labels, display unit titles
- 7 Reproductions and replicas
- 8 Models and dioramas
- 9 Walk-through sets and reconstructions
- 10 Period rooms
- 11 Costume mannequins
- 12 Object supports

The budget, time and expertise available are a determining factor. Small museums may have excellent exhibitions based on simple wood or plywood panels that may be easy and inexpensive to produce, while museums with more substantial exhibition budgets may prefer more sophisticated materials. The important thing to remember is that whatever system or material used,

the curator, conservator and security specialist must be involved in the decision-making, and that the exhibition structure needs to be easily assembled and disassembled and accessible for everyday cleaning.

Completing the exhibition

Once all building work, electrical wiring, decorating, wall, floor platform and panel fixing, and fixed showcase assembly has been completed the free-standing showcases and wall-mounted furniture and exhibit structures are put into place. The working area then has to be thoroughly cleaned, including the glass or acrylic glazing for cases and other display units, and the lighting is tested.

Then the fixing of title panels, other text and graphic units, illustrations and photographs can be carried out by the design team or contractor, after which the installation of the original objects by the curators or conservators can begin. Any costume figures are dressed at this stage and finally the lighting is adjusted and tested for both effectiveness in terms of illumination, and of safe lighting levels according to agreed conservation needs. Finally, the curator, conservator, education specialist, designer and any other specialists, and usually the director also, review the display or exhibition and approve the final result. After this the showcases are closed and there is a further full cleaning of the exhibition space ready for the opening to the public.

Evaluating the finished exhibition

It is most advisable that each new display or major temporary exhibition be evaluated using recognised methods. Most rely on evaluation as soon as possible after the opening: this will identify quickly any major mistakes or problems, such as circulation difficulties so that necessary modifications can be carried out. However, one of the leading researchers into exhibit

effectiveness, Chandler Screven (1985), has described a method to carry out the process during the exhibition installation, before it is open to the public, and therefore discover and correct mistakes and problems at the earliest possible date. Evaluation is also always very important in helping to find better solutions and working systems for the future.

Exhibitions and museum communication and education

The public displays and exhibitions are the museum's most important means of communication. Its potential and capacity for communication is therefore the major issue to keep in mind when planning and designing an exhibition, whatever the theme, mode or type.

There is now a very wide range of mass communication technology resources that can be applied to exhibition design, and many of these are becoming relatively inexpensive. A good designer will seek to enhance communication by creating attractive displays that place the emphasis on the desired highlights in terms of the objectives of the exhibition, often by drawing on experience from theatre illumination techniques. The aim throughout must be to motivate the visitor and enhance curiosity.

Educational psychology fundamentals have also been integrated to exhibition design as well as didactics, semiotic concepts, graphic design principles and, of course, art and aesthetics. One distinguished museum designer, the late Michael Belcher (1991), says that exhibitions are conceived as sculpture, though I would argue that they are even closer to architecture, since forms, solids, voids, colour, texture, together with technical instruments and processes, conform the exhibition that aims at communicating concepts, feelings, facts or pleasure. Indeed, in a number of major countries around the world museum exhibition design is mainly carried out

by architects, rather than by professionals specially trained as museum or interior designers.

Museum exhibition is essentially a form of visual communication. It achieves this through the museum objects and works of art, aided by the use of graphics and written information in the form of text panels, captions and individual object labels. The ultimate aim should be to communicate the message of the display or exhibition in a clear and precise visual and written language, easy to understand at whatever level or levels of interpretation are intended, just as in a good newspaper or magazine.

UNIT 2			2. THEME 2. History and fundaments		
			2.1. Subtheme: From Prehistory to Industrial Revolution		
Subunit	Observations	Goal	Message	Exhibition material	Display technique
2.1.1. Introduction	Introduction label on historical development...	To explain the convenience of initiating the museum visit...	To show historical perspective to better understand...	Label	Silk screen
2.1.2. The Sun	Relation between Sun movements and climate...	To show that primitive people recognized the importance...	In the past, solar energy was not exploited artificially, our ancestors...	Label Illustration Object	Silk screen or digitalized images

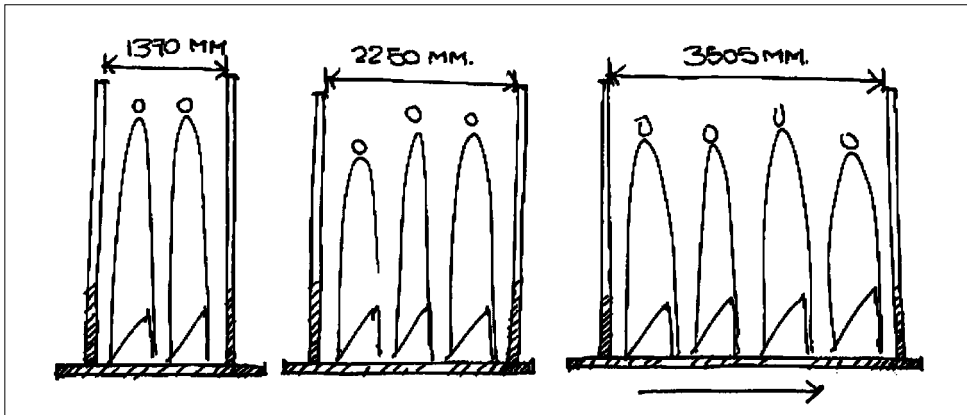

Minimum recommended circulation width

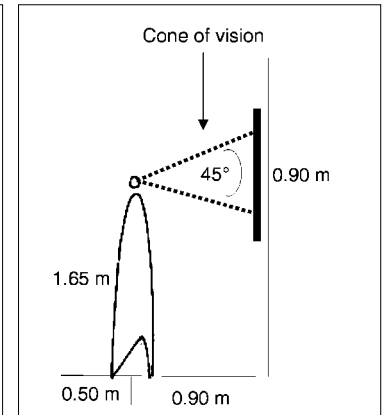

Recommended cone of vision

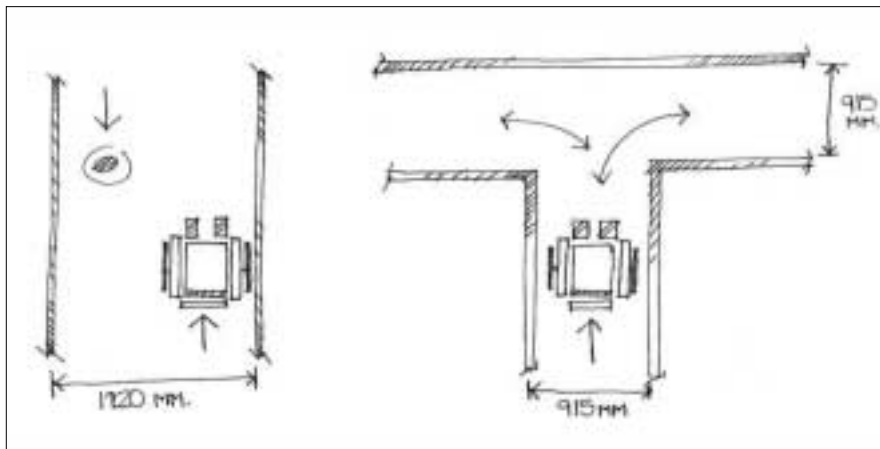
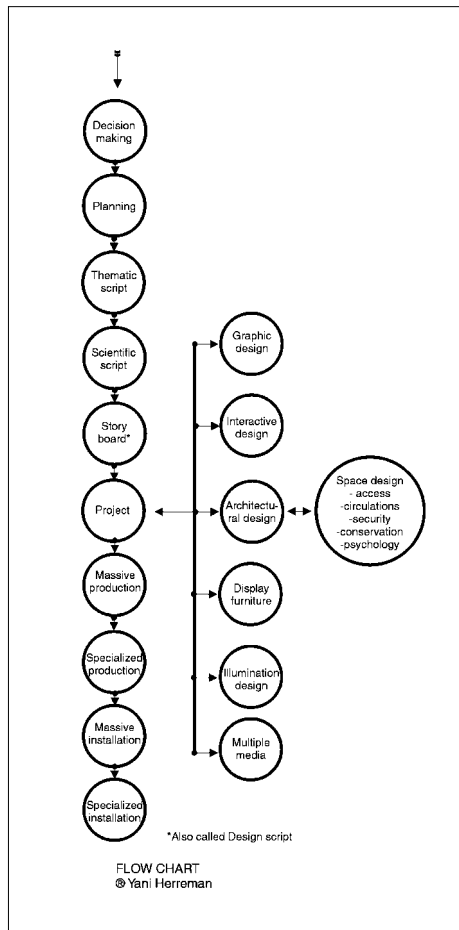

Ergonomic standards for wheelchair users (1)

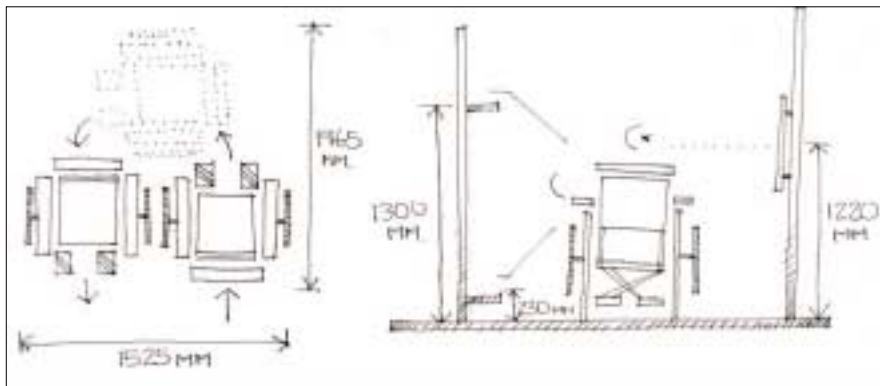

Ergonomic standards for wheelchair users (2)

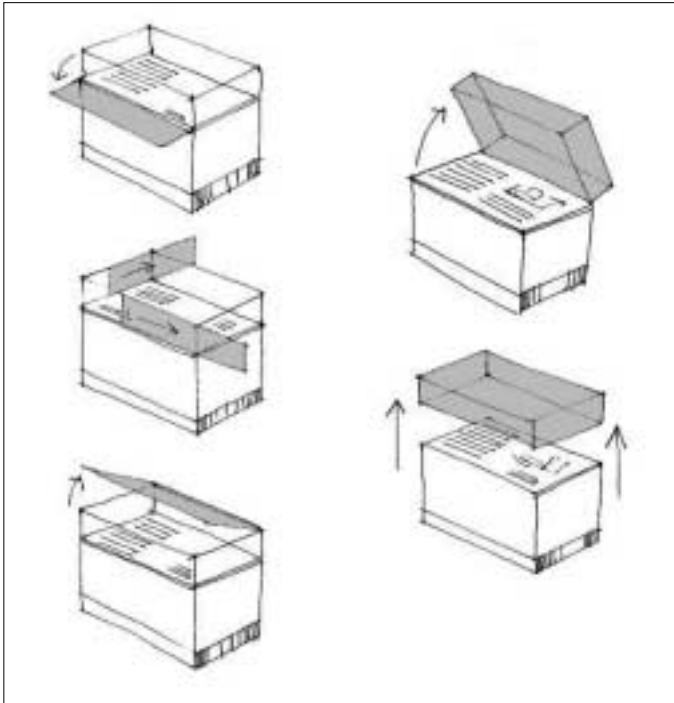

Free-standing showcases

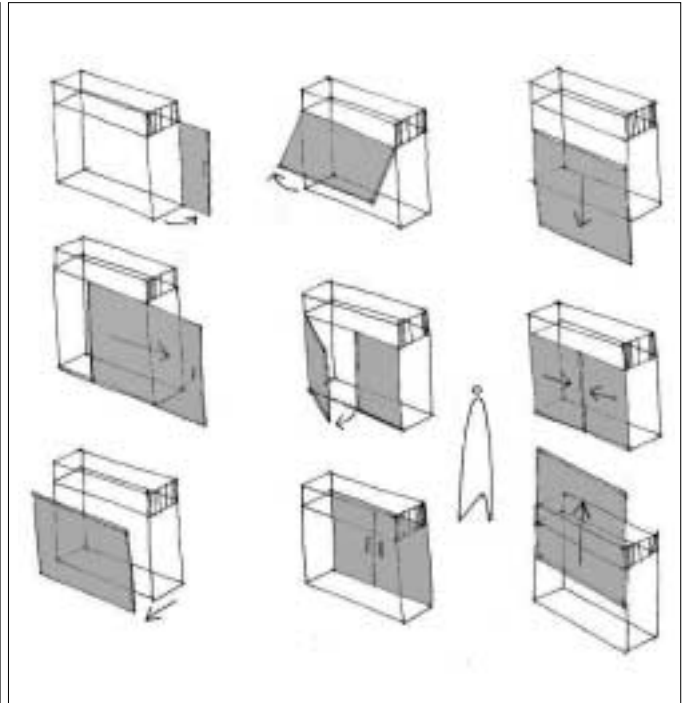

Wall-mounted showcases. Issues to take into account when selecting type of showcase: 1. maintenance; 2. security; 3. conservation; 4. costs; 5. visibility; 6. easy handling.

Caring for the Visitor

Vicky Woollard

Senior Lecturer, City University London

Introduction

Both national policy makers and individual staff throughout the museum need to place the visitor at the centre of the museum, its services and resources.

This chapter aims:

- to set the background to the rise of visitor services and offer definitions to certain terms and phrases;

- to discuss the benefits of implementing services which will deliver a quality experience for all visitors;

- to look at how one collects information about visitors, their views and experiences;

- to discuss the needs of different visitor groups, actual and potential;

- to outline the management issues in running a Visitors Service;

- to look at a typical visit made by a visitor as a check list for museums staff to use.

The aim is to guide the reader through the fundamentals for setting up and running a quality visitor services for a large or small museum.

Definitions:

What are visitor services?: These are provisions that the museum makes in the physical, intellectual and social sense to enable the visitor to have an informative, pleasant and comfortable visit. Good visitor services reduce levels of frustration, discomfort and fatigue, and help the visitor to enjoy the exhibitions and events. Without good visitor services the opportunities for enjoyment and learning are radically reduced, and the number of return visits will fall.

Box 1

Just sit and think for a moment or two. Where have you recently received good service: a hotel, a shop, on board a train or aeroplane, at a bank or perhaps a government office? What did the service consist of? How did you assess whether the service was good or not? Did you receive a welcoming smile, clear and accurate information, clean and working facilities, the sense that time was given to your query? Were your expectations exceeded? What sort of service and experience do visitors receive at your museum? Are their expectations exceeded?

Exercise 1: For all staff: each staff member contributes to two lists naming the characteristics they think contributes to making a quality service and a poor service. Through discussion get agreement as to which are the top 10 positive characteristics and have these as the basis of establishing a standard all staff will support.

What is access? Visitor services are central to the coordination of public access to the museum. Access is giving the visitor the opportunity to use facilities and services, view displays, attend lectures, research and study the collections, and to meet staff. This does not only mean physical access, but also includes access at the appropriate intellectual level that is free from social and cultural prejudice.

Background

Over the past two decades, museums have increasingly moved the needs and expectations of their visitors up to the top of their agenda. This concern and the effort to offer a range of quality visitor experiences has arisen from a number of factors.

Firstly, visitors, both local and international, themselves have become more sophisticated and selective about where they wish to spend their money and limited leisure time. The expectation of being given value for money has increased the expectation of having a good day out. Even if admission is free they wish to be assured that the time and effort they put into a visit will be rewarded through being entertained, learning something new and feeling welcome and comfortable in the surroundings.

There is now plenty of competition to attract visitors away from museums. Museums therefore need to keep their current visitors and encourage new ones as they have found that the additional income generated from the shop, events and from refreshment sales, provides much needed additional financial resources. The rise in visitor figures are a crude but emphatic measure of success and, if sustained, demonstrate clear visitor satisfaction. But also at a deeper level there needs to be a commitment to social responsibility, nation building and cultural identity.

Museums themselves have recognised that in order to be considered a valid and active participant in their society, they must be accessible to all, of real use by giving value in terms of providing resources for intellectual refreshment and debate and spaces for contemplation and inspiration.

For governments, at local and national level, there is pressure to demonstrate to the citizens that their taxes have been spent wisely and the public benefit is visible and tangible. Tourism can also be a key factor in raising both

national and museum income, and museums and heritage are frequently central to the tourist package. Investment in museums is vital if these are to provide the standards that experienced global tourists now expect to receive.

What are the benefits for museums?

Before one launches major management changes and investment of resources, the museum needs to be convinced that there will be benefits from providing quality visitor services. These benefits can be immediate or be developed over time.

Raising staff morale: When a member of the public says ‘thank you’ to a member of staff, leaves with obvious signs of pleasure, or writes praiseworthy notes in the visitors’ book, instantly it will have a positive reaction. Such expressions of visitor satisfaction, if shared and praised will raise staff morale and in turn create enthusiasm and renewed energy to tackle challenges corporately. The museum gains a positive spirit to move forwards.

Marketing potential: With visitors feeling that their time was spent well, felt welcomed and encouraged to return, they become ‘publicity agents’. They are likely to tell their friends and colleagues, and return with visiting relations. Most marketing and publicity specialists will say that recommendation by word of mouth is the most effective form of advertising. And of course it comes free!

Forming support (or “Friends”) groups: Satisfied and enthusiastic visitors can become longer term supporters who will support the museum by giving time, and/or money to help the museum achieve its ambitions. Supporters can be volunteers, individuals giving up their spare time: for example repacking collections, assisting on the information desk, or supporting staff in organising the library. Supporters can also be individuals who donate money or help to raise funds for the purchase of collections or for improving facilities. They

can become ‘critical friends’- those who have your interests at heart but feel confident to offer alternative views and suggestions. This critical look at the museum’s activities is vital to sustain and improve standards. Some supporters may have useful connections with other professional or business groups and so give advice on specialist areas such as education or interior design.

Advocacy: Investment in creating long term relationships with the local neighbourhood is crucial for any museum who wishes to demonstrate its value to society. All museums will need to have support from its public and that support must be maintained and developed by allocating staff time and resources. Museums are not unfamiliar with financial cutbacks. But the demonstration of a loyal group of visitors and local community can provide persuasive evidence to politicians, businesses and the press that yours is a successful organisation and worth investing in.

Professionalism: Serving visitors and other audiences is part of the very essence of a museum. The uniqueness of collections and their place in the understanding, research and interpretation of the past needs to be made public in order to gain confirmation of their importance. Regardless of their employer, as a profession, staff are in effect public servants and publicly accountable for the care, management and interpretation of these collections for the benefit of society. Neglecting the public is the equivalent of neglecting the collections in terms of a museum’s basic responsibilities.

What are the underpinning principles for providing quality visitor services?

Politicians, government officials, museum staff and the public all need to understand the fundamental values of a museum which inform and shape current and future policies and plans. Some examples which readers may like

to consider appropriate according to their circumstances in relation to actual, virtual and potential visitors:

- 1 Human rights and equal opportunities
- 2 Open consultation with all stakeholders,
- 3 An integrated visitor services policy and strategy
- 4 The quality of the visitor’s experience (actual or virtual) as the professional responsibility of all staff

1. Article 37 of the Universal Declaration of Human Rights 1948 states:

“Everyone has the right freely to participate in the cultural life of the community, to enjoy the arts and to share in scientific advancement and its benefits.” Part of that right of participation in the cultural life is the right to access museums, and their collections, displays, services and facilities, without any discrimination on grounds of age, sex, religious or cultural beliefs, disabilities or sexual orientation.

2. Open consultation with all its stakeholders

For a museum to fully understand the needs of its audiences and visitors, it has to be in touch with its various audience groups and others with a legal, financial or moral interest in them (nowadays often referred to as “stakeholders”). These are all those people who would directly or indirectly be affected by the action of a museum including employees, government officials, the local or national community, researchers and other museum professionals as well as the visitors. A number of museums have set up consultation arrangements with their identified stakeholders, either by seeking out individuals with particular expertise (but not necessarily museum visitors) or through working with groups that regularly visit the museum, such as schoolteachers and a “Friends of the Museum” organisation.

Such groups and individuals can be invited to respond to just a single issue, say a temporary exhibition, or to maintain contact over a longer period of time, perhaps

contributing to the planning of disabled access or of educational materials. This has become particularly relevant for some children's museums/centres, which have developed a council of children/young people who regularly meet with staff to discuss a range of issues, ranging from what is sold in the café to what should be the museum's logo. This consultation can save the cost of spending on ideas, material or equipment that may not be appreciated, desired or needed.

3. Providing an integrated policy and strategy for visitors' services.

The use of advisors and visitor groups would be a key part of a museum's visitor services policy. The role of such a policy is to lay down the guiding principles and the desired goals the museum wishes to achieve for its visitors. The policy should be accompanied by a strategic plan which shows how resources (staff and financial) will be used to realise these goals over a set period of time. Please look at the reference section for sites that discuss visitor service/access policies.

Box 2

Some key issues to consider in developing a visitor services policy statement:

1. Underpinning principles for visitor services policies
2. Staff responsibilities across the museum for delivering, monitoring and reporting procedures
3. Analysis of the various ways in which the museum, its collections, galleries, services and facilities are made accessible to both general visitors and specialised visitors and users
4. Standards which the museum aims to achieve
5. Staff training needs and achieving these
6. Ways of consulting and evaluating the visitor and their experience
7. Communication systems and channels

4. The care of the visitor (actual or virtual) is the responsibility of every member of staff

There needs to be a strong lead from senior management to ensure that all staff understand that each should contribute in creating the best environment for visitors to access and enjoy the collections and building. It is not only those staff who have direct contact with visitors on a daily basis who are responsible. It is just as much the responsibility of those who work "behind the scenes", whether a cleaner, cataloguer or finance officer. Understanding and responding to visitors' needs should always be taken into account in the planning and delivery of work of "behind the scenes" staff too. For example, museums are recognising that, thanks at least in part to the development of museum websites, there is an increase in public enquiries and research about the collections. Because of this, staff are having to reconsider the whole process of recording information on each object so that in future this can be easily transferred from the museum catalogue or other database to the web page in a format that will be easy to access and digest: in future the catalogue may need to be redesigned so that it is visitor friendly rather than registrar friendly.

Defining and Understanding the Visitor

To become a visitor-orientated museum it is vital that you are first aware of the range of visitors that you currently serve (actual visitors), and who you wish to attract in the future (potential visitors). If you have a website you would also have virtual visitors.

Potential visitors are also those who are far less likely to visit museums, for example people with disabilities, families with young children and toddlers, people with low incomes and cultural minority or recent immigrant communities. Many of these people may not have experienced a museum before and so have very little idea

of what an attractive and effective museum may offer them. For some there may be barriers (actual and perceptual) that prevent them from coming. These may be financial, such as unaffordable entrance charges, physical, such as flights of stairs at the entrance and as part of the internal circulation, or social or psychological, such as a reputation that the museum staff do not like visitors with young children. The museum staff need to analyse honestly and consult about actions needed to remove these barriers. Visitor services can enable the museum to gain a positive reputation.

Virtual visitors are those who relate to, and use, your museum by visiting your website, through correspondence or by mail order purchases from the shop. Many museums were at first concerned that visitor numbers would drop if they provided Internet access to the services, collections and even the exhibitions, but experience now shows that these fears were unfounded. In fact the web has been seen to raise people's awareness to museums, encouraging them to make an actual visit. Those planning to visit the museum find an informative website an excellent way of preparing for the visit in advance.

Researching your visitors

Visitor surveys tell you about your visitor, their visiting patterns, needs and attitudes. The results from these surveys inform you as to how you should plan for the future. Visitor surveys fall into two types: qualitative and quantitative.

Qualitative studies give information on how people respond to the museum experience. These studies allow people to express their opinions or attitudes, or to be observed in how they manage their time and route through the galleries. Quantitative studies are about gathering statistical data such as how many people live within a certain distance from the museum, how many

Box 3

KNOWING YOUR ACTUAL VISITORS

Actual Visitors (those who come through the door): the more you know about your visitors the better you will be able to plan ahead and prepare for them.

1. Do you know who your current visitors are?
2. Which of these and how many make repeat visits?
3. How does your current visitor profile reflect that of the local communities? Is it the same or different? Do you think that it should reflect the profile of your local communities? How many of them come on their own rather than in family or other groups?
4. How many are local visitors, and how many are tourists from outside the region?
5. Are you aware of any seasonal trends in visiting?
6. Are there differences in numbers and types at different times of the week/month/ year?

come by public transport or by car, or to find out the percentage of tourists to local residents. Most museums use a combination of both types through a range of collection methods such as one to one interviews with open ended questions, through focus groups or tracking.

Using visitor surveys requires planning. An important point to consider at the outset is what are the objectives of the study and what will become of the information gathered. These questions will determine the type of survey you set up and the questions you will be asking. Also you need to think about how the data will be presented for ease of access (a report, a grid of figures, a list of recommendations) and to which audience (e.g. government, staff or exhibition designers). You need to bring together all previously collected information to ensure there is no duplication. Or you may wish to use that information as a base to show trends over a number of years, in which case you will need to be careful to collect data according to the same criteria in successive surveys.

BOX 4: EXERCISE 1. Getting to know your potential and virtual visitors

Either in small groups of staff, or individually, use the notes below to analyse the possibilities for turning potential visitors into actual visitors, and for developing and expanding a community of “virtual” visitors.

Potential visitors (those non-visitors who you would like to attract to your museum). They may well fit the profile of your current visitors (let us say researchers), but you are aware that many more could make use of your study facilities).

1. What do you need to do to attract new visitors or various types (e.g. scholars and researchers, families with children, organised groups from schools and colleges ?
2. Are your opening hours convenient for general visitors or special groups, such as students and researchers wanting to view the reserve collections?
3. Are details of opening hours and arrangements for special access to collections easily available?

Virtual visitors (those accessing the museum or its facilities and information through the Internet or by mail)

- 4 If you already have your own museum website, look at this to see how user and visitor friendly they are.
- 5 How many clicks does it take to get to the visitor information?
- 6 Is it clear from the images and the style of writing that the visitor is welcomed?
- 7 Does the museum recognise different needs of its visitors?
- 8 Does the website suggest that consciously or subconsciously the museum has a hierarchy of visitors, considering researchers first and families last?
- 9 If you do not yet have your own website, examine several websites of similar museums in different countries and regions, and evaluate them using questions (5) to (8) above.
- 10 Use these analyses to improve your own website or to prepare the specification for your future museum website.

BOX 5: SOME VISITOR RESEARCH TECHNIQUES

Questionnaires: These are carried out by visitors on their own completing a short list of questions, perhaps by ticking the appropriate box. More complex questions that may need more than one word answers usually require an interviewer to ensure that it is completed and also relieves the visitor from writing themselves. The offer of refreshments or a small gift from the shop will help people to relax and is recognition of the favour they are giving you.

Focus groups: These are groups of 5-9 people drawn from the general public who are invited in advance to share their thoughts on certain issues or developments; such as asking parents what they think are the important features required to making a visit successful. This is good for exploring ideas in depth and for gaining people’s interest in your work. However it is time consuming and needs some skill in managing the group so that all feel that they have been able to contribute fully. Participants would expect to receive refreshments at least.

Postal and Internet surveys: Postal questionnaires can be sent out to people whose names and addresses you have collected from the visitors’ book, group bookings or from correspondence. This can be quick, efficient and fairly cheap but again these may represent only a certain type of visitor. If you have a website, Internet-based questionnaires can be offered in addition.

Visitors Books and Comment Walls: are excellent for capturing people’s unsolicited views and ideas – these are often used for promotional material and can be indicators to attitudes that the majority may have, but should not be the only guide.

Valuable information can be gathered through one to one discussions with visitors, from a brief questionnaire form completed by the visitor on their own, or through an individual observing. All such data collected will have flaws in it, either from lack of accuracy (e.g. counting numbers coming through the door) or from unconscious bias in choosing people to interview – e.g. selecting only those who look as if they have time to spare). If the data is to be valid the number surveyed is important. A sample of 500 people is generally regarded as necessary for a general visitor survey in a smaller museum, 700 to 1,000 may be the minimum for a larger museum, while visitor response to an exhibition probably requires a sample of at least 100. (The international Visitor Studies Group website – see the bibliography - provides much more advice on these points.)

It is worthwhile to consider working in partnership with a University or market research company for help in developing some basic skills and knowledge on how to set up surveys that will produce quality information.

Types of visitors and their needs:

Every one of us can be categorised by different criteria and fall into different groupings.

The groups described below are not the only ones, and of course one individual could fall in to one or more at the same time or through their life cycle.

Individuals: These tend to visit for a specific reason, probably to see a particular collection or exhibition, or with a research interest at either an academic level or for personal pleasure. As independent learners they want to have detailed information on the items or collections or given guidance to other sources. They are likely to attend conferences, lecture series and guided tours, provided by the education and curatorial staff. This group may include the retired whose eyesight and hearing may be

deteriorating and so would appreciate large print labels or audio guides. They will like to take time to study displays or paintings and would appreciate portable stools or firm permanent seating at a suitable height in the gallery space.

Independent adult groups: These are often adult individuals who form groups for social purposes and some of their time in the museum may be spent in conversation and relaxing with one another. Museums offer “safe” and aesthetic environments for people to meet and chat. The museum needs to recognise this social function and provide suitable seating areas, cafes and other meeting points suitable for such smaller groups.

Family groups: This group of visitors has a wide range of needs due to the range of ages and interests. Encouraging families means that the museum is encouraging interest in museum visiting at an early age and creates a pattern of social behaviour for life. Family groups often extended to cousins and other relatives and can be major components of the domestic tourist sector. Some, certainly a minority, of museums feel that their collections are not appropriate for young children, but with creative thinking, even complex intellectual topics can be made accessible through special displays, activities or leaflets and quizzes. Family groups include adults who may well return on their own at another time. A successful museum will aim to greet family groups rather than just tolerate them.

Educational groups: Depending on the number of groups that visit the museum and the role of the museum’s education staff, arrangements may need to be made for the following: spaces for bags and coats; a gathering space that will enable the group to discuss their plans on arrival, a place for eating packed lunches if it has been a long journey, and the provision of clip-boards or notepads for writing on. As many groups may arrive

BOX 6: EXERCISE 2: Making the museum family friendly:

Look through the following checklist and decide whether your museum is family friendly or not at the moment. Identify simple practical ways in which things could be improved.

1. Are there activities, such as quizzes or special exhibits for the children to be involved with, especially during holidays? Good links with the Education staff will help to plan these. Refreshments will need to include low price items and perhaps the museum can provide a place for families and groups to eat their own picnics.
2. Washroom/toilet facilities should include basins and toilets at a lower level for younger users plus baby changing facilities for mothers. (These facilities are often combined with toilet facilities for the disabled who among other things also need more space, not least so that helpers and carers can assist them.)
3. A family with small children may bring push-chairs ("strollers"). Will these be allowed into the galleries?
4. Or can the museum provide smaller carriers or baby backpacks?
5. Other furniture may include high chairs in the café and small boxes for children to stand on so that they can see into the exhibition display cases.
6. Remember that a contented child means a contented family, and also that the happy child visitor is likely to grow up to be an adult visitor, and eventually a parent (and perhaps even a political leader with responsibility for museum policy and funding decisions).

BOX 7

1. What is the maximum size group the museum can accommodate in the various key areas, such as general galleries, a particular special exhibition, the museum shop or café?
2. Is there a booking system for groups available so that education leaders can reserve a gallery/ space in advance, and to make sure that the building does not become overcrowded and unsafe?

BOX 8 - National and International Tourists:

Visitors in this group tend not to have the time to linger, hence small guidebooks or leaflets on the "highlights" of the museum are a great help. Another priority is to offer translations of the guidebook or provide tour guides who can offer different languages or prepared sound guides. Other questions to be considered include the following:

1. If the local tourist office or perhaps a travel company provides a guide, how do you ensure that the guides have had some training from the museum and meet required standards of accuracy?
2. Does the museum need to consider how many groups can visit at one time?
3. Are there spaces where groups can gather and relax in the open? What is the maximum size group the museum can accommodate in the galleries, shop or café?
4. Is there a booking system available so that tour guides can plan ahead?

by coach, a safe set-down point and bus parking may be needed. College/lycée level and higher education groups which often include art students should have the opportunity to use portable stools for sketching. (These can be also be used for older visitors.)

Visitors with additional needs (physical and mental disabilities):

All of the above groups can include individuals who have additional needs and requirements. Information about the services and facilities that are available for those with disabilities should be included in all the general visitor information. It is important that all visitors with disabilities receive the same quality of attention as the general public and are not treated in a condescending manner. Visitors with special needs are frequently

accompanied by a friend, relative or carer, and museums that charge for admission often recognise this by giving free entry to the helper, and perhaps the disabled person also.

All relevant staff should have training from specialists who are either themselves disabled or who have worked alongside people with a range of different disabilities. Museums that have made special arrangements for people with disabilities have found that these can be welcomed by other visitors as well. For example providing ramps or lifts as an alternative to stairs not only helps those in wheelchairs, but also parents with children in pushchairs/strollers for young children, or anyone having difficulty in walking or carrying a heavy load.

At a local/regional and national level, specialist staff may be available to provide advice and training to museum staff to establish the minimum levels of visitor access and services every museum should attain. If this help is not available locally or within the country it should be possible to work in collaboration internationally with other professionals or organisations who have developed expertise in this area.

For wheelchair users: consider ramps, special toilets to accommodate the wheel chair, ensure that gallery displays are visible from a wheelchair (this is also an issue for children), check there is space to manoeuvre the wheelchair around the display cases, along corridors and in the shop and café. An advisory group of users with disabilities, such as wheelchair users and those with poor sight or hearing can be a great help in testing out facilities, seat planning, exhibition designs. (See the paragraph on Support Groups in Dodd and Sandell, 1998)

People with little or no vision require large print or Braille labels. The print size is recommended to be no less than 14 point but 16-18pt is thought advisable to suit a wider group. Print should be black on white or yellow background. Many museums provide these labels

in folders at the entrance of a gallery or at the side of the display case for easy access. Sound guides offer a good alternative, but can cause problems with managing the handset. Many museums have invested in providing 3 dimensional plans (raised maps) of the gallery layout so that the individual can feel independent and not always reliant on passers by. Some visitors may be accompanied by a trained guide dog which will require water and of course should have access to the galleries and other public spaces. (See Royal National Institute for the Blind and the Museums Association – Museum Practice site.)

Visitors with hearing disabilities appreciate that regular guided tours, lectures and other such events have on a set day a signed interpreter available. Some museum staff have had training in sign language but it must be remembered that there are some visitors with hearing problems who do not use sign language but lip read. (See reference for link to the Royal National Institute for the Deaf –UK for examples and advice on good practice.)

People with learning difficulties (referred to as mental handicap in some countries) will require special material to help engage their interest and require sensitive support from gallery staff, as will those with mental health problems. It is recommended that museum staff work closely with specialists in these areas who can give professional advice as to what would be the most appropriate material and activities, as well as provide staff training.

Planning and managing visitor services

To ensure that a strong commitment to effective visitor services is embedded into the organisation at all levels, the museum can establish a number of ways in which staff can coordinate, communicate, share expertise, plan and deliver services to the public. In particular it is necessary to involve at least three groups: the Director and other

senior management staff, the visitor services team and the museum's communications group, as follows:

Director and Senior Management team

To create a museum-wide interest in visitors requires commitment from the Director and senior management team (SMT). They need to create appropriate management structures, to set goals, agree standards, evaluate success and weaknesses. For this it is helpful to designate one member of the team to have overall responsibility for Visitor Services. That individual should see that SMT meetings have a regular agenda item for visitor services, that the budget has an appropriate designated sum allocated to visitor services, and should hold regular meetings with the Visitor Services team and the Communications Group (see below). The SMT need to decide visitor services policy, such as how much public access can be provided, on opening up of stores to visitors, on research on databases, and on providing financial budgets. The SMT should also report on these important matters in the Annual Report.

Concerning finances, the SMT will of course need to consider visitor services investment especially when building works, fixtures and fittings are required. The physical environment of a museum can have a great impact on the visitor and the way they are made to feel comfortable, and in creating the mood for viewing exhibitions and participating in activities. Such obvious things as lighting (artificial and daylight), floor surfaces, style and type of furniture, paint colour can make you feel either calm and relaxed or tense and uncomfortable. Seating should be provided in the galleries to enable people to sit and contemplate: a seating area with reference books and other information, perhaps including computer access to the museum's information services, gives the visitor a sense of independence and

encourages further reading, study and return visits. The provision of portable, lightweight folding stools stored neatly by being hung on the wall in the corner of the gallery can be a cheaper option.

Effective communication has two distinct parts. Good communication channels between staff are needed to bring together all the required information for the visitor, while the communication with the visitor is largely dependent on the effectiveness of the methods used to communicate that information. These two have to go hand in hand and if one is lacking or deficient in some way, the clarity and usefulness of the information will be affected. Incorrect information will frustrate all, while correct information poorly communicated (e.g. through bad signage or poorly designed leaflets) will miss the target and be wasteful of resources. The SMT may wish to set up a communications/information group (see below) to establish a framework that improves the speed and flow of communication, both internally and to the public.

Visitor Services team

The team may include receptionists (at the visitors' desk and on the telephone switchboard), gallery security staff, special events management personnel and education staff. In fact, it should include all the staff who meet the public face to face on a regular, if not daily, basis. Decisions have to be made as to who is responsible for what duties, how should the team coordinate their activities, and what is the purpose of each activity (educational, fun, security and safety). Should all the Visitor Service team be easily identified by uniforms, badges or some particular accessory such as a tie or scarf? Important decisions also have to be made as how to arrange a work schedule so that all public areas are staffed throughout the museum's opening hours, (which

are likely to be longer than the normal working week for any individual employee).

Another important policy decision is how should complaints be dealt with? Service-orientated organisations always encourage users to give their honest opinion about their experiences, and aim to learn lessons from both complaints from those who are dissatisfied as well as other comments and suggestions. For example, many display prominent notices saying something like: “If you are happy with what we are doing, please tell your friends. If you are not happy, please tell us instead.” It can be a good idea to have a single feedback system for the compliments, complaints and other comments of visitors and other users, as some who want to make a suggestion for improvement will not want to call these a “complaint”.

The Visitor Services team with the senior manager need to set up systems for monitoring and evaluating services offered. Having decided on the level and standard of service, staff can regularly check if everything is in place and at the standard required. What type of checks should these be and how often? Who will carry them out? Are there issues to do with attitude, timing, accuracy? How will these be resolved while maintaining morale and staff motivation?

Communication / Information Group

This group is likely to bring together representatives of a number of different aspects of the museum’s work. Its primary role is to set up mechanisms by which information is gathered, checked for accuracy and disseminated in a variety of formats to different audiences. The purpose is to ensure that all information is up to date, accurate and accessible. This is not only for the public’s benefit but also for the staff. The group is likely to include a graphic designer who understands visual communication, someone with good editorial skills, an audience advocate, members

BOX 9. Developing a Visitors’ Comments and Complaints Policy and Procedure

Whatever the detailed arrangements it is important that the museum has, and publicises, a written policy on complaints and how these are dealt with. The policy and arrangements should include:

- The complaints and comments procedures should apply to all who have contact with the museum and its services, whether as visitors including school and college groups, researchers, users of special museum services such as an archaeology or antiquities service, or those making enquiries.
- Those complaining or offering compliments or suggestions should be able to do so in any convenient way: during or after their visit, in writing, by telephone, (or through Internet services where the museum has e-mail or a web page).
- In the case of those who are making a complaint or comment in person in the museum, they should be offered an opportunity to speak to the duty curator or other senior member of staff if he or she is available.
- Special forms for complaints, comments and other feedback are very useful as these help to make sure that all key information is recorded, but the museum should equally accept and act on verbal reports, telephone calls or letters.
- In the case of verbal or telephone complaints a member of staff should record as much information as possible – preferably on the official complaints and comments form. In all cases the person making the complaint should be asked to give a postal address or other contact point to which a reply (or request for further information) can be sent.
- All complaints should be treated confidentially, and there should never be any discrimination against someone because they have made a complaint.
- Procedures for investigating and replying to all complaints and comments should also be established, and should make sure that:
 - There are adequate internal arrangements for investigating and replying promptly to all complaints and comments.
 - All complaints and comments should be acknowledged in writing promptly (7 days would normally be reasonable); these acknowledgements should always give a timetable for investigating the point and sending a reply.
 - If it proves impossible to meet this timetable then a further letter or message should be sent explaining the delay within the original time limit.
- If a complaint is justified, then the museum should apologise as promptly as possible and explain what action is being taken to prevent this problem arising again.
- All replies should ask the person making the complaint or suggestion whether they are satisfied with the reply and with the way in which the complaint has been dealt with, and tell them how they can take the matter further if they are dissatisfied.

EXERCISE: Check your present arrangements for considering complaints, and draft written guidelines for the future.

of the visitor services team and the museum's webmaster or web editor.

Their particular concerns will include:

Information: What information, to whom and how is it presented? Who provides the information, how often? A key point is to fix a realistic time schedule for having information brought together – whether daily (e.g. information on gallery events, group bookings, room use), weekly (e.g. staff absences, collecting visitors figures), monthly (e.g. the events diary), quarterly (e.g. temporary exhibitions), annually (to check all basic information is still correct e.g. telephone numbers, travel details). The communications team will also want to review what information can or should be offered in different languages.

Signage to and in the museum: Is it visible, clear to read (even for foreign tourists: perhaps international or other symbols or pictograms can be used?) and does not clutter up the spaces to become visually overbearing and confusing? Where and how many signs should be placed outside the museum? From where would people approach the museum: bus stops, car park or by foot? Are different entrances clearly marked (some museums have a special schools entrance or for those with wheelchairs)?

Orientation within the museum: Museums can be large and complex buildings, but even small exhibitions which are full of material and are laid out in a circuitous route can make the visitor feel tired and disorientated. No one likes being lost. This creates tension and anxiety, wastes time and could possibly negate all the learning and enjoyment that had been acquired up to that point. Good pocket sized maps should be available, with location maps displayed at gallery entrances and on stairs and in lifts. All staff should be trained to give guidance and directions: people are often hesitant to enter places they do not know and where they cannot see the exit.

Specific areas for attention

Inquiries/Reception Point: Having a central point where visitors can gather information is essential. This point is often identified by a desk which has gallery maps and events leaflets, and is supervised by a member of staff to answer inquiries. For the museum this can also be an important point for security (checking bags), and an emergency and health and safety control (e.g. managing a safe and calm evacuation in the event of fire). (However, this range of staff roles can be confusing both for staff and the visitor.) As this may be the first point where the visitor is welcomed by the museum staff it is important that the desk is designed to be welcoming and accessible, in physical terms such as height, be uncluttered in appearance, as well as in the manner and approach of the staff. The appointment of staff that have had customer care training and an aptitude to working with the public is essential, as they will be at all times focused on the visitors and their requests.

Cloakrooms for umbrellas, coats and bags/buggies: This should be open throughout the museum's opening times. A notice needs to explain the limit of the museum's responsibility. Is it clearly signposted near to the entrance? How would you organise staff to help at busy times (at closing time)?

Toilets: These to be checked for cleanliness, soap, towels and paper regularly throughout opening hours and regularly cleaned and checked that they are in working order daily. Other key questions include: are these clearly signposted? Are they suitable for a person in a wheelchair or for someone to change a baby's nappy (diaper)?

Café or Restaurant: Museum visiting is tiring and people need to have some sort of refreshments, particularly where visitors typically remain in the museum for a long period, or if they are likely to have travelled for some time before arriving at the museum. The size of operation will also

depends on the overall budget for the museum, since in smaller museums at least it may well be that the income from the sale of the refreshments will not cover the full cost of staffing and equipment overheads. However, even offering tea or coffee and a cake can make all the difference to the visitor's experience of the museum. The café is also an ideal place to promote future events and to display exhibits, perhaps from the reserve collections. If it is not possible to have any sort of catering service then perhaps the museum could look into having a water fountain or drinks dispenser as a very minimum.

The Shop: This is another obvious point where visitors meet staff, as they buy guidebooks, catalogues, replicas or souvenirs and ask for information. This also raises important visitor service and communications policies. What should the shop sell, and at what price? Is there something for children to buy at a very small cost? Can customers order things away from the museum? Is there a catalogue of publications, replicas and souvenirs, and if so is this available through the museum's website? What are the museum shop's opening hours? How much storage space is there for the shop and its stock? If space is limited how does this determine the range and size of stock being held? Is the shop well lit and does it have space for people to browse?

Outdoor area: Having an outdoor space such as a garden or space for objects too big or heavy to go inside the museum can be hugely beneficial for visitors. It allows for contemplation and reflection plus being a change of physical environment. Benches and sunshade covering need to be available and, if popular with families, some simple play equipment, perhaps picking up themes from the collection, will be very popular. Such a space can also be ideal for events or be rented out for private hire.

BOX 10. Checklist from the visitors' point of view

The following exercises are methods by which the museum monitors and evaluates the standards and provisions you have put in place. The evidence collected helps to prioritise your actions for the future. Evaluation is the mechanism for checking and refining processes, results and outcomes. Evaluation can take place at different stages of a particular series of actions.

1. At the beginning, "front end" evaluation is there to test out ideas or prototypes during the project.
2. Formative evaluation allows you to make changes or improvements,
3. Summative evaluation give you the opportunity to gather a range of evidence that summarises the strengths and weaknesses of the project so as to inform future actions.

Exercise 3 : Ask two newer members of staff (regardless of grade: it does not matter whether they are a cleaner, gallery attendant or curator) to work through the following checklist and add any questions of their own. Use 3 columns to grade the museum's status as follows: (1) good standard (2) adequate but to be improved (3) failing. Use the results to help to form the action plan for the coming year.

This exercise should be repeated at least annually to see if the situation has changed. Of course what determines "good" has to be discussed which encourages all to participate.

General indicators: What are the indicators that show the visitor your museum takes them seriously and that you are concerned for the quality of their visit? Is there a short paragraph on all your literature/ web site on a board at the museum's entrance that declares your intentions?

Arrival: Is the road to the museum easy to locate? Are there good directional signs to the museum for car drivers and pedestrians? Where to park the car? How far is it to walk to the entrance? Are there spaces near the entrance for people with disabilities?

Welcome and Orientation: Who welcomes the visitors? How do they greet me? Are they polite and do they give accurate information? Is it clear what to do on arrival and where things are: toilets, cloakroom, information desk, education rooms, galleries? How do I find out what is happening today? What is available for a family, children, people with disabilities, people wishing to carry out research? How long have I got before it closes? Is there a charge, how much, and are there any concessions for children, the elderly? Am I allowed to take photographs? Take my child around in a pushchair (stroller)?

The galleries: Am I visually attracted to the displays? Am I drawn into the space or is it dark and gloomy? Can I read the labels? Is the lighting well directed? Are the galleries noisy or empty? Do I understand the intellectual context and content of the displays? Can I find out more about the exhibits than what is on the label? Where do I have to go to find this out? Can I sit down anywhere? Can my child learn at his level and be entertained? Can every one see all the displays at a comfortable height? How do I get from one place to another? Who can I ask if I have a query? How do I recognise them? Can I have a drink or something to eat? Are the refreshments inexpensive? Can I sit out doors? Are there toilet facilities?

BOX 11. Researching visitor services

Exercise 4: Ask a few members of the public (preferably not regular visitors) to do the same exercise as in Exercise 3 to gauge visitors' reactions compared to the staff. This can be done by letting them talk to you as you go around – Again points raised are added to the longer term visitor services action list.

Exercise 5: Two museum staff at a time should visit an unfamiliar museum or other visitor attraction (heritage site, fun park, shopping mall: it does not matter whether this is a public or commercial facility) and note things that they felt worked well or failed in respect of being a visitor. What standards did they choose to use? Their reactions and comments can inform the debates with the various teams/groups. Such opportunities should be given to all staff, especially those in the Visitor Services team, as it brings home to people the immediacy of reactions (emotionally and intellectually) when one is experiencing a situation oneself.

Summary

For a museum visitor to gain the most from the learning and pleasure opportunities made available, they need to feel welcomed, safe and assured that these collections are on show at least partly for their benefit, and are a part of their heritage and understanding of their place in society today. Contented visitors are increasingly valuable to museums as they are not only a measure of one's success but can become regular return visitors and perhaps become even more closely involved as enthusiastic supporters and advocates. To achieve this, the museum and its entire staff need to plan and deliver Visitor Services and facilities that provide and improve public

access, understanding and enjoyment of the collections. A satisfied visitor is the proof of a well-focused and professionally run museum.

Further Information

The Museum Association (UK) and in particular its quarterly publication "Museum Practice" provides a great deal of practical information on a wide range of relevant issues, such as Visitor Services, Access, Design, Labels. Museums which become institutional members receive free copies and gain access to the archive of past issues on the Web. Please contact the Editor, Museums Association, 24 Calvin Street, London E1 6NW, <http://www.museumsassociation.org>

There is a lot of relevant literature on visitor services, visitor studies and customer services in areas beyond museums, including leisure services, tourism, heritage and culture, as well as business management.

Museum Education in the Context of Museum Functions

Cornelia Brüninghaus-Knubel

Head of Education Department, Wilhelm Lehmbrock Museum, Duisburg, Germany

What are museums for? What is the purpose of all the efforts in collecting, restoring and displaying objects? It is certainly not merely an occupational therapy for curators or those who do research in the field. It is also not only about the pride in representing the culture of a nation or of the world's common heritage. In fact, this is undertaken in order to make the museum's knowledge and collections known to the public, to people of all ages and backgrounds, and to let them participate in knowledge and culture. Consequently it is important that every action of the museum should aim to serve the public and their education.

Museums add special values to the formal school and college education system, as part of the informal sector of education. They enlarge the formal education and offer different ways of learning, enjoying and discussing. All museum professionals, whatever their particular job or specialization, need to have a strong belief in the need to share with as many persons of all ages or social levels as possible knowledge of the importance of discovering and understanding the roots of mankind and their creation of culture as well as the natural heritage of our planet.

Continuing education for people of all ages, from very young children to older retired people – from under three to over ninety-three - can take place in museums: The individual enjoys the opportunity for open, informal visiting and for communication with others (in a way that is different from theatre and concerts) while groups have different experiences from those of their usual learning environment. Educational services in

museums also enhance and complement the understanding and enjoyment of the collections and displays. Because it is a crucial part of the overall objectives of the museum, education should be regarded as one of the main goals in the museum's policy. Without such a policy commitment, museum education tends to become viewed as a mere marketing ploy aimed at increasing visitor numbers.

Collections and education

Taking into account the close relationship of all museum functions, the issues of museum education have above all to be considered in relation to the nature of the collections. Whether made up of artefacts or natural history specimens, technical objects or archival material, every collection requires thoughtful analysis, working together with the scientific staff, in order to develop a specific and relevant educational orientation. As soon as the aims are defined, educational programmes can be designed to promote better understanding of the objects and other aspects of the museum's curatorial and scientific mission.

This must be done for both museum education teaching sessions or for the educational orientation and content of the displays and exhibitions, both permanent and temporary. Each step should be guided by the responsibility towards both the visitor and the nature and message of the collections and objects. Also the choice of objects for the public displays and exhibitions depends on the themes that are inherent in the collection

and are at the same time of interest to the public. This is likely to vary according to the different target groups to be addressed, to particular contemporary issues, or to the special needs of society.

The objects or specimens in the museum's collection carry all sorts of information. Find out which are relevant for your different visitor groups and which content is important to convey. Then, use this knowledge to decide upon the programmes to be set up and the methods by which the learning processes can be accomplished.

Heritage and education

Furthermore, for many museums, especially community-related ones, knowledge of local traditions and regional culture are crucial when establishing a museum policy which combines the museum's educational and curatorial work. Different museums preserve an extraordinary range of heritage of different kinds, e.g. reflecting national or international sources and values. In a period of unprecedented speed of change, today people are very often on the brink of forgetting or neglecting their own history and cultural traditions and lack knowledge about other cultures and the wider world heritage. A museum is the perfect place to promote and encourage awareness of the natural, cultural and artistic heritage, through the research carried out by museums and others on the material and immaterial culture studied and preserved by the museum and through the opportunity to educate visitors

Developing and Managing Museum Education

If the museum sees itself as an institution with a strong social and educational commitment, the establishment of an effective educational service ought to be seen as a matter of course. As long ago as 1965 the 8th General Assembly of ICOM adopted as official ICOM policy a declaration,

that in view of the greatly increased significance of the educational and cultural role of museums, they should employ specialist museum education staff – either qualified teachers who should then be given additional training in the basic disciplines of the museum or academic (including curatorial) personnel who should be given additional training in educational methods.

Unfortunately nearly forty years later, education is very often still regarded as of only secondary importance. Even where there is a specialist education department this may well have a low position and status in the museum's departmental hierarchy. The best examples of visitor-oriented museums have had museum educators appointed and already working in the museum's development team long before the official opening. However, there are still many museums that survive without any education department. Even if they become conscious about their obligations towards the public and decide to create an education department, very often these start off with just one person. This lone professional is then expected to carry out all the different tasks described above.

What kind of person must this be? In most countries, there is no specialist training which prepares people for the museum education profession. Instead, the best present-day museum educators have qualified (usually at postgraduate level) in many different fields during their careers. Many have studied the subject matter of the museum they work for – e.g. archaeology, biology, history, physics, or studies in education or psychology will have provided the basic pedagogic knowledge, for it is vital for the educator to be respected academically by his/her curatorial colleagues. In addition museological training is absolutely necessary, whether through specialized (postgraduate) courses or through experience as a trainee in a museum. Some courses of teacher training may be

suitable, but it is important to understand that learning in the museum can be very different from learning in schools, particularly where the country has a tradition of very formal school teaching and learning.

Once a museum has decided to establish an education service and has found a suitable candidate to run it, the new education officer has to set up a structure and decide on a policy and programme. This has to be realistic in terms of what can be accomplished according to the museum's situation, particularly the staff, time, space and finance available. As a minimum, an effective education service requires a full-time professional head who is capable of handling the management and administrative aspects of the job as well as taking part in the teaching and other educational work.

Long experience shows that while a single education officer is better than nothing, one person will not be able to carry out every necessary task, especially once schools, colleges, parents and the wider public recognise the value of the educational programmes offered by the museum. It is inefficient and uneconomic for a highly qualified education officer to have to undertake routine secretarial jobs such as taking bookings, distributing publicity material or printing teaching and learning materials because of the lack of necessary administrative assistance.

Public demand for the educational services is likely to make it necessary to engage additional specialised staff for guiding, teaching and for conducting the educational workshops and other activities. Freelance or part-time staff can undertake many of these functions under appropriate contract arrangements and supervision. However, such staff must be trained by the education officer or other experts in order to maintain quality standards. This training and continuing professional development needs to cover a wide range of topics, including current knowledge of learning theory and psychology, and

information on new research in the museum's subject matter, as well as communication, presentation, and any relevant special aspects of the job, such as historical crafts and techniques. Therefore the museum educator must be a leader or manager as well as a true team player.

Networks inside and outside the museum are essential for the educator's work. They can help with the orientation towards the public, and they may be a source of new alliances and thus broaden the educator's professional horizon and thus the service provided. Most important, they can facilitate problem-solving. Here, networking with other museum professionals should be emphasised, especially for inexperienced museum educators.

Communication with other museum workers both inside the museum and elsewhere can be particularly valuable in relation to the exchange of ideas, advice and know-how. These communicative efforts keep the museum educator up-to-date with contemporary issues, studies and discourse, thus enabling him or her to meet the needs of the profession and those being served. Outside networks can be joined at the national (e.g. museum association) or international (e.g. International Council of Museums (ICOM) and its specialised international committees) level. If none of these are suitable or accessible, other networks can be created on your own initiative. In addition to such professional contacts a lot of time and patience needs to be devoted to establishing personal contacts locally: as an expert in communication, the museum education officer can link institutions and people, groups and individuals and open pathways for co-operation.

Museum education and the community

As an institution of public interest and for public use, the museum as a whole needs to be situated intellectually at the centre of its local, national or international

Assessing the Principles and Priorities for a Museum Education Policy and Programme

As every museum is unique, the museum educator, in consultation with curatorial colleagues, needs to ask some basic questions in analysing and planning the education service. These will differ according to circumstances, but may include:

Concerning the geographical situation:

1. Is it serving a big or small community?
2. Are the surroundings urban/industrial or rural?
3. Does the museum relate effectively to its geographical situation?

Concerning the social and cultural structure of population:

4. What are potential visitors like?
5. What visitors and other users do we want to come to the museum and why?
6. What are the community's cultural traditions: can these be linked to the museum's objectives and policies?
7. What are the contemporary problems the community has to cope with?

Concerning museological issues:

8. What are the key features of the collections?
9. What are its origins?
10. What are the museum's obligations towards outside parties, such as the State, city, other funding bodies or donors?

Concerning finance:

11. What funding sources are available specifically for educational work?
12. What is the most effective use of the available museum education budget?

community. The museum educator has a particularly important role to play in developing the statements of the museum's mission, policies and programme. They bring an especially valuable insight to the policy-making process, because of their close contact with the public and excellent knowledge of the expectations and possible

reactions of different groups in society, and particularly with the young people who should also be valued as future museum visitors.

As the museum's expert in relation to the public, understanding the needs and wishes of the different visitor groups, the museum educator has to contribute his/her knowledge in the overall management of the museum, for example when new displays are being discussed. As part of the team, the educator should be able to contribute vital information about perception, intellectual ability and interests of the visitor groups. This requires a clear definition of which target groups are to be addressed and how. Starting from the analysis of an object or a group of them, teaching programmes have to be developed.

Many different approaches can be offered: for the individual visitor, whether adult or child, special groups or schools. All of them should no longer be regarded as only "consumers" of culture or knowledge, but as partners in the process of learning. Hence, the goal of the museum educator should be to communicate the various values and aspects of cultural or natural history, of art or science to the visitors in such a way that these comprehend them and can compare them with his own experience in the field.

Choice of Teaching and Learning Methods in Museum Education

To convey the meaning of the museum object and to enhance understanding, a range of educational methods can be used. Some methods and media are aimed at a passive recipient. Here, the learning process evolves through thinking, perceiving, examining, recognising. Others encourage the visitor to become actively involved and examine the collections, displays or individual cultural object being studied through an aesthetic, technical, social or research activity.

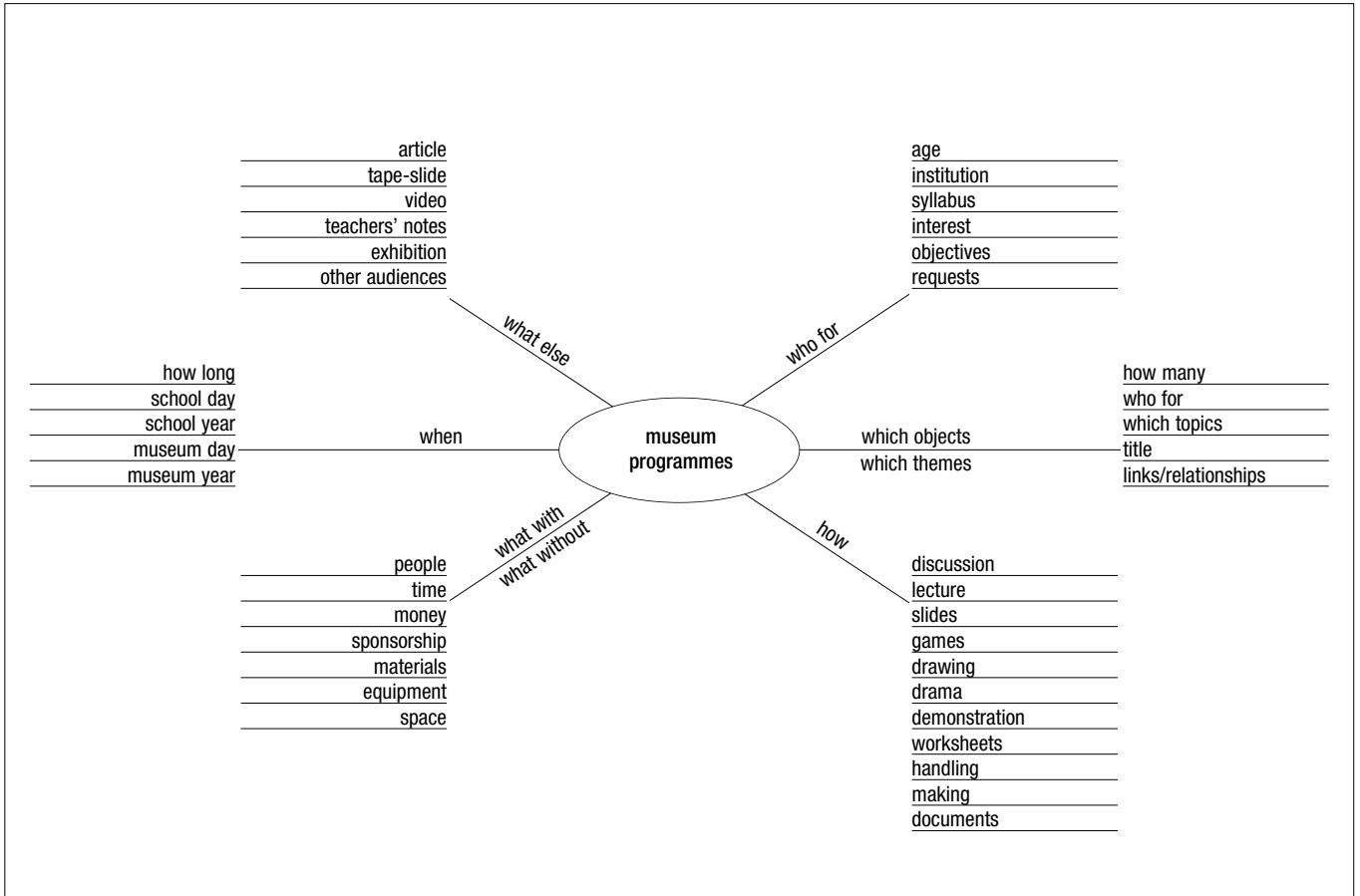

Fig. 1. Issues in the planning and management of museum programmes (from Eileen Hooper-Greenhill, *Museum and Gallery Education*, Leicester University Press, 1991)

General Exhibit Labels and Individual Captions

As a minimum there should be information about each object displayed, e.g. class, function, origin, material, age, and contents. However, nowadays most museums offer much more information than this, with text panels and individual object captions and labels that provide more

comprehensive information about the subject of the display overall and the context of the individual object or groups of objects. Organised museum education groups visiting the public galleries are likely to need additional didactic material relevant to the age group or specialisation of the students concerned.

The museum education specialist can be of great help to colleagues within the museum who are planning and designing displays and exhibitions by offering expert advice on issues such as comprehensibility, linguistic

Designing educational programs: the basic principles

1. Start from the knowledge and life experience of the audience.
2. Provide opportunities for conversation and discussion that help students to handle new ideas and to develop reasoned arguments
3. Offer first hand experiences for the senses and the mind including:
 - a. Looking
 - b. Describing
 - c. Touching
 - d. Moving
 - e. Drawing
 - f. Playing
4. Let the student or other visitor find his/her personal expressions for what they experience
5. Allow the opportunity and time for individual exploration
6. Plan any programme of educational visits carefully, taking into account e.g. the schedule of the local school year, the season of the year, and the time of day
7. Allow the group time to adjust to the new teaching and learning space in the museum
8. Build into the programme preparation before the visit (e.g. pre-visits or training courses for the school's own teachers, or the written information or learning materials provided in advance) and the follow-up to the visit
9. Evaluate each visit or organised programme and consider possible changes for the next time.

level, typography and graphic design, communication, and also on the value of a particular object or groups of objects within the display's concept and objectives.

Guided Tours and Educational Dialogue

Among the means of museum teaching, the classic approach relies largely on the medium of speech. However, the formal lecture style traditionally used with educated adults should be replaced by less formal dialogue or conversation, especially when working with children, young people and persons with a non-academic background. In order to get away from the

school style question-and-answer pattern, museum educators today use a range of forms of interaction. The active participation of the schoolchild or other participant is encouraged, taking into account all senses and encouraging self-expression. Instead of explaining everything to them, let them explore and find out, describe and experience what they see. The museum educator helps them to discover the meaning for themselves.



Fig. 2. Exploring an art-work in the sculpture exhibition of Wilhelm Lehmbruck Museum Duisburg, Germany

Audio and Audiovisual Media

As a substitute for human guides, museums are using audio guide systems: portable tape recorders or CD players and headphones providing a commentary for an individual tour around either a particular exhibition or the highlights of the whole museum. Alternatively, such commentaries and information can be provided at different points within the exhibitions through loudspeakers or other audio devices offering both

commentaries and recallable sounds (e.g. animal voices, historic radio broadcasts, music) that contribute to the content on display.

Audio guides can impart a lot of information very easily, but this can be at the expense of normal conversation and communication among the visitors, though a limited use of recallable sounds can contribute to the display. Audiovisual media has a high potential for museum education, if used in the right way. Slideshows with sounds, film, and video/TV clips can promote an effective reception. An advantage of audiovisual media is its capability to bring information from the real world into the museum, e.g. work processes, human or animal behaviour, illustrations of surroundings from which the object has been collected.

Educational Spaces

A promotion of education in a museum must go along with the provision of adequate spaces for this work. These can be exhibition areas that focus on educational exhibits designed to illustrate a particular topic, classrooms, workshop spaces or other study areas that can be used for an extended period of time by school and other educational groups as well as by the individual visitor. Special museum education spaces are usually supplied with supporting information and material which allow intensive and active examination of topics covered.

Visual and Computer Media

In many cases, graphics, such as diagrams, maps and photographs can be very useful to illustrate a concept and to achieve clear coherence. Museums are increasingly using computers for the same purpose. With networked computer terminals and free-standing PCs using specially designed software, visitors can learn interactively about a technical, artistic or scientific



Fig. 3. Hands-on-workshop in permanent exhibition on local tradition of pumice fabrication at Landesmuseum Koblenz, Germany

process or about historical facts, with multiple choices of information that the user is free to select.

Increasingly this supporting information is available to people far from the museum through World Wide Web links, and already in some cases “virtual visitors” to the supporting education and information programmes of the museums now exceed the number of actual admissions. Though a computer-based information and learning systems can contain and make available a wide range of information, it carries with it the danger of distracting attention from the displays and original objects themselves.

Didactic/Educational Exhibitions

In contrast to a more traditional object-oriented presentation, a didactic or pedagogic exhibition is often argument-oriented. This is achieved by making sure that (1) educational aims are prominent in the concept, (2) content, design, and educational assistance must be closely related to the argument to be conveyed, and that (3) the particular target group at which the exhibition is

directed has a priority. With educational exhibitions, active styles of teaching should mainly be used.



Fig. 4. Bubbles: playful activities for learning in exhibition “Seifenblasen” of Kindermuseum München, Germany

Practical Workshops

Activity workshops, which may be conducted by freelancers who are specialists in their fields such as working artists, scientists or craftspeople, offer visitors the possibility to explore techniques connected to the making and preserving of cultural objects, or to undertake scientific research or inquiry. For example, traditional crafts like pottery, wood and metalwork, cooking, fire-making, or other local traditions may be experienced and rediscovered. Art is better understood through trying out the original techniques of printing, drawing, painting, sculpting and photography. Using a microscope, excavating, taking pictures and systematising information on objects for archival research may give an introduction to scientific work.



Fig. 5. Trying out techniques : Paper-making Workshop in the exhibition “Vom Brei zum Buch” (From Pulp to Book), Kindermuseum des Historischen Museums, Frankfurt, Germany, 1998/99

For example, in art, these sessions, perhaps close to masterpieces, are, especially for the young, a lively means to convey aesthetic and design principles (form and colour, space and composition). Here, first steps towards a promotion of creativity and sensitisation to cultural objects can easily be made. But painting and drawing workshops do not belong solely to an art museum’s educational programme: they have their place in natural and cultural history museums as well. Transferring the viewed objects and the acquired knowledge into an artistic form can deepen the learning and the sensory experience.

Tactile Displays and Aids

Some museums encourage the visitor to touch selected real cultural objects in a controlled setting, such as a special display or a tray of handling specimens, or they provide handling samples of the materials that the object was made of, e.g. stone, animal fur or textiles. These can be invaluable not only for blind and partially sighted students and visitors but also for work with children.



Fig. 6. Blind museum visitor perceiving sculpture by Ossip Zadkine by touching with his hands. Wilhelm Lehmbruck Museum Duisburg, Germany

Learning Games

For children, playing games imitates the rules of the real world. Thus, games and guided play can have an important place in the learning process. Competitive games, games of skill, puzzles, quizzes, historical games, etc. can all be successfully transferred to museum contexts.

Educational Demonstrations

Experts such as craftspeople, artists, technicians or restorers can demonstrate their crafts and artistic work in the museum setting. Actors or talented educators can play the role of a historical figure. Here, interaction with the visitors is crucial.

Role-Playing and Museum Theatre

In museum education, role-playing is usually an improvised experience structured through directions and guidance from the project leader (such as museum education officer) concerning the characters or the story to be represented, but without a formal script and

directing of the acting. A subject for a role-play in a museum could be improvising what happened after the scene depicted in a painting or the re-enactment of historical events. The visitor can mix interpretations from his contemporary world into the historical context.

This form of play can easily be included into a guided tour and can get visitors moving: this is especially important for the work with children and teens. In addition, a growing number of museums now use more formal theatre performance in their programmes, typically using both professional actors and child/student participation on a role-play basis at the same time.



Fig. 7. Role-play: writing like a monk in medieval times. Exhibition “Vom Brei zum Buch” (From Pulp to Book), Kindermuseum des Historischen Museums, Frankfurt, Germany, 1998/99

Tableau vivant

In this, members of the group recreate paintings and sculptures of people and groups of people, perhaps wearing replicas of the costumes illustrated. Through this physical experience, posture, gesture, and facial

expression can be better understood and interpreted in relation to oneself.

Teaching “Kits”

Educational aids and sets of handling specimens can be assembled in carrying boxes, suitcases or any other sort of container. They can be used either in the museum as teaching material by the educators themselves, or - being self-explaining- by the independent visitor. Teaching kits can also be used outside the museum as part of a loan service for schools.

Material that is put together in such kits usually focus on specific subjects which are derived from the museums collection and general programme, and offer a wide range of supplements and aids for learning, such as written information, pictures, recorded voices or music, replicas, raw material to be touched or used for creative work, games, how-to-do-instructions, worksheets.

Field/Discovery Trips (see also the section on Extramural Activities below)

When linked to exhibition and collection themes, field trips can widen the visitor’s focus beyond the museum’s walls, e.g. arranging excursions to caves and quarries related to geological collections; visits to monuments, public statues and historic buildings relevant to art and cultural history museums, or excavation sites as part of the educational programme of archaeological museums. These also offer the chance to meet interesting people whose professions are relevant to the museum. Such activities can give a lively impression of how the objects of a collection are linked to the lives and activities of fellow citizens.

“Collect/Document/Display” activities

The museum institution itself can be of interest to the public, not only the museum object itself. Under this



Fig. 8. Loan material from Kit about the culture of North American Indian, Rautenstrauch-Joest Museum für Völkerkunde, Köln, Germany

title some museums have developed an activity which takes the visitor behind the scenes of a museum. In the setting of either a didactic exhibition or a hands-on project, museological techniques like collecting, doing research, and finally displaying can be explored. The programme can include interviews with representatives of the different museums professions, observing and possibly participating in work processes, role playing or re-enacting museum work such as collecting, setting up an exhibition, coping with difficulties (e.g. a theft or a damage). These aim to give the educational group much more insight in the value of museums and the heritage they preserve, showing that there is real and exciting work being done in the museum.

Supporting Programmes of Educational Events (see also Informal Education below)

The museum education service may also organise and promote a supporting programme to supplement and enhance either the regular displays or temporary

exhibitions. These often include film and video screenings, theatre and concert performances, readings, courses and conferences.

Museum publications

Information on the collections or a temporary exhibition can also be conveyed through the classic medium of a book, booklet or catalogue. The text and illustrations can consolidate knowledge and reactivate experience of the exhibition. It is important that the museum keeps in mind the intended readers and users: publications, guides and catalogues for children and teenagers need to be designed accordingly. The texts must be comprehensible and entertaining and can include comics and pictures. In contrast the more advanced reader will appreciate fuller information and interpretation and also the results of the more advanced research carried out by the curators or outside specialists.

Extra-Mural Activities

Outreach Programmes

The museum today is regarded as an institution that must have a strong relationship with, and responsibility towards, society. It has to serve a very wide and diverse public, from enthusiastic regular users and supporters, through to those who know little or nothing of the museum and what it offers and never visit the museum building. In other cases the apparent lack of interest in, or use of, the museum may be due to difficulties in geographical accessibility or lack of adequate transport systems. Also, economically disadvantaged communities and individuals may not be able to afford the time or money to travel to the museum.

Outreach programmes can overcome this gap, by offering opportunities for experience and learning to schools and individuals living in places without

Types of Didactic Material commonly used in Museums

A common request from schools is for materials designed to support the formal curriculum and examination process. However, specially prepared teaching aids can also be used in both passive and active educational frameworks, with or without personal guidance from the museum educator, for children and students of all ages, from kindergarten through to both formal and informal adult education.

Examples of the kinds of material produced for independent use include:

- Worksheets
- Learning games printed on big posters
- Card and dice games
- Model theatres
- Hands-on books and catalogues
- Quizzes
- Art and craft supplies
- Audiovisual devices (CD players, audio recorders, video recorders and cameras)
- Objects and material to touch, to smell, to taste

In addition the museum educator may use the following aids for his/her teaching, to help explain and expand knowledge beyond the museum object:

- Charts
- Diagrams
- Maps
- Overhead transparencies
- Slide sets
- PowerPoint and similar computer presentations
- Texts
- Lesson plans
- Films
- Museum teaching and learning website
- Reproductions and replicas
- Teaching Kits (museum in a suitcase, mobile teaching units with various materials and media)

museums, e.g. rural or remote areas. They aim to make members of the public aware of the value of the museum and its services with the aim that they will be eventually attracted to visit the museum in the future.

Buses or vans, staffed by museum personnel or perhaps trained museum volunteers or local teachers, can be used to transport mobile units containing objects and educational material related to the museum's mission and organised in the form of exhibitions or educational activities of all kinds, such as workshops, museum theatre or kits of handling specimens. The educational value of the programme is guaranteed by the conceptual input and professional management by the museum educators.

Education departments in museums employ trained and committed persons (teachers and other educators, designers, craftspeople and other specialists) who are able to work with the varied target groups. It makes sense to send these experts outside the museum to work in the different institutes of the neighbourhood, community centres, with minority groups or in schools.

Local libraries, town halls, schools, community buildings or other public venues can all serve as temporary spaces to host these shows, but the bus or truck itself can be designed as a mobile exhibition room. Teaching programmes are often designed in conjunction with such local community organisations that may provide staff members to work with the travelling exhibition or other outreach programme. However, when original specimens are included in such programmes, proper professional procedures of security must be followed.

Another form of outreach is the development of loan services, which can provide a smaller scale version of the "mobile museum" or "museobus" just described. For this purpose kits of original material or e.g. teaching packages in the form of miniature versions of educational displays.



Fig. 9. Museum Bus from National Museum in Gaborone arriving at a remote village in Botswana for Outreach program



Fig. 10. Teaching with Museum objects in classroom in remote village in the Kalahari desert in Botswana

Loan kits need to be stored, advertised to their potential users, administered, and kept in good condition. In addition many museum loan services of this kind also offer

schools and other users a delivery and collection service. Thus a loan service can involve a significant workload and therefore cost, which needs to be taken into consideration when planning such a service.

Fieldwork

Following contemporary ideas of education which place an emphasis on learning through experience, the school field trip can be adopted as part of the museum education programme as well. All the collections in the museum originated from outside it, in many cases locally, so why not follow them back to their origins? Such projects can give a lively experience, giving insight into e.g. archaeological excavation and archaeological methods at the site where museum objects have been found.

During archaeological, geological or biological fieldwork, students and volunteers may be able to undertake collecting and categorising specimens, so that the participant becomes actively involved in the learning process with the result of sustainable knowledge. Museum-organised excursions to monuments and sites, to other museums and places to meet interesting personalities such as artists in their studios or scientists in their laboratories or field stations, can be aimed not only at school groups but also at interested adults. In these cases the museum educators are acting as programme designers, relating the museum to the outside world.

Informal Education

Events and Leisure Time Activities

As well as being educational, museums are a great place not only for education but also for enjoyment. The museum buildings may be beautiful or otherwise of great interest in their own right. The collections and exhibitions can create an atmosphere full of imagination and emotion

which can be enjoyed by the audience. Thus, cultural and entertainment activities and events can be integrated into the programme. Other forms of the arts contribute to a broader concept of culture. For instance, programmes including poetry readings and musical performances, theatre or dance can be enhanced and inspiring by being presented surrounded by museum objects.

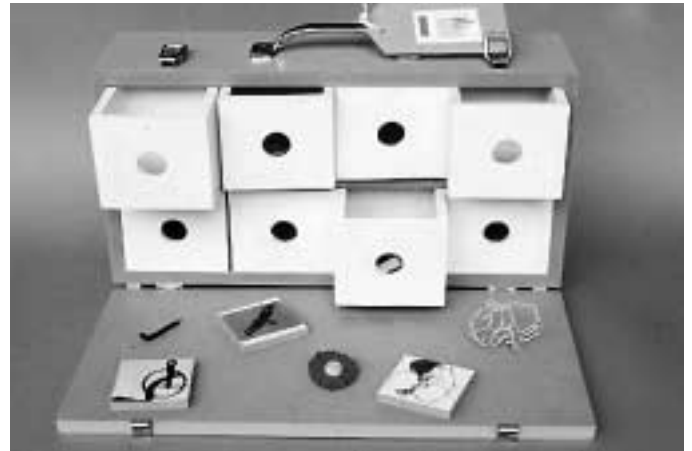

Fig. 11. Museum-Box for individual families visiting museums: games to discover artworks, Wilhelm Lehbruck Museum Duisburg, Germany

Another means to attract a new public to the museum is to invite well-known artists for a performance and as a result attract their fans. Also, conferences and symposia involving the curators and other specialists are often organised on topics of museum interest: these can deepen knowledge and promote discussion of arguments.

Once the museum becomes known for such varied and attractive programmes, it should attract more and more social groups, e.g. institutions, companies, associations and work groups or student groups. Given its expertise,

the museum staff can offer to design events especially for the needs and interests of such groups, and this could become an opportunity for the museum to make some money and attract a yet wider public. However, the museum has to consider carefully in what way any particular event relates to its own mission and objectives. This is not just a matter for museum educators and public relation officers: such questions go to the heart of the museum's objectives and policies, and it is likely that the director and senior management, possibly the governing body, will need to be involved in setting policies and guidelines for such programmes.

Today, both young people and adults tend to choose quality leisure activities, and look for rewarding and interesting ways of spending their time. Museums are able to meet such needs through active learning. They offer opportunities to engage in an enjoyable way with knowledge-related concepts.

Museum educators therefore need to design a wide variety of both formal and informal programmes that are meaningful and at the same time entertaining, so that even after a day at school or work, participating in workshops, courses or events at the museum provides them with experiences that enhance their quality of life.

Museum Management

Gary Edson

Executive Director, Museum of Texas Tech University, Lubbock, Texas

Most museums exist for the public's benefit, and, to be successful, all aspects of their operations should reflect that obligation and commitment. Any organization operating in the public interest must manage its affairs properly, but museums as custodians of the cultural, natural, and scientific heritage of a people, region, or nation have a special responsibility to function as nearly as possible above reproach. Museums operated or maintained as part of a governmental structure are normally required to function according to the management system of the governing body. Within this limitation, however, the museum should maintain at the same time proper operating systems and procedures which follow accepted museological practices.

Directors provide the leadership, vision, and guidance that are a part of good management.

In some national traditions, management is used to describe the level of authority within the institutional structure where important decisions are made. The most senior manager may be known by other names such as director or chief executive officer (CEO), and it is that person who normally makes many key decisions about the way the museum is organized, the services it provides, and the people it serves. In other traditions, "management" in one way or another is regarded as an important part of the work and responsibilities of most professional staff, and probably the more senior technicians as well, not just of the director and his or her deputies and perhaps one or two administrative departments, such as Finance and Personnel. For example, in the United Kingdom, the government now

classifies nearly 30% of all the country's workers as having significant management responsibilities, and formal management training has been an important part of the national qualification structure for museum curators and other museum professionals since as long ago as 1964.

The director is usually hired or appointed by the governing authority, such as a board of trustees, board of directors, the Minister of Culture, or a regional or city government. The powers of the director will depend very much on relevant national or local laws and regulations. Some directors have the authority to make day-to-day operational decisions including the hiring and disciplining of staff, while under other systems this responsibility remains with a government or city personnel service.

It is very important for all with management responsibilities in this wider sense to understand the administrative and legal systems and structures applying to their circumstances, as well as the detailed laws and regulations under which they must work. In practice these will vary greatly from country to country, and several decades on from decolonisation it is very common to find that most of the administrative and legal principles and practices established by the former colonial power are still in place, and still significantly affect both museum management and professional practice.

Across the Arab world there can, for example, remain major administrative, legal and even philosophical differences between former French colonies and mandates such as Algeria, Syria or Lebanon, and former

British territories such as Iraq or Israel/Palestine, while similar differences are seen across Sub-Saharan Africa, the Caribbean etc. There are also big differences from country to country in the language used: the very word “management”, now universal in English-speaking countries is much more likely to be called “administration” or perhaps “gestion” in a country with a French, Spanish or Italian tradition of public service.

EXAMPLE OF POSSIBLE PRACTICAL EXERCISE

Exercise 1: In relation to your own museum, investigate and summarise the main national and local laws and regulations affecting both museum operations and museum management (including financial and personnel management)

A key role of museum management is assisting the organisation, regardless of its size or complexity, in achieving consistent results so the institutional mission can be articulated and fulfilled. Of all the factors that contribute to sustained success in museums, one of the more important is creating a cohesive and effective team. Sustaining such a team requires leadership, vision, and a commitment to the value of team effort. The most powerful function of an effective manager is that of inspiring others to be part of the team. The transfer of power from one or a few to many involves the delegation of tasks and the sharing of responsibility.

Effective museum management is a responsibility that embraces all the resources and activities of the museum, and involves all the staff. It is a necessary element in the development and advancement of a museum. Without proper management, a museum cannot provide the

appropriate care and use for collections, nor can it maintain and support an effective exhibition and education programme. Public interest and trust can be lost without qualified management, and the recognition and value of the museum, as an institution in the service of society, can be jeopardised. It needs to be a reflection of a high level of social development with personnel with a range of educational and decision-making skills.

The modern museum must be an informative, professional, systematic (in its collection care), enjoyable, and socially active institution, and arguably traditional methods and practices of management are becoming increasingly obsolete. To meet the many new challenges, museum management needs to understand and apply contemporary management principles drawn from research, and “best practice” in business and public service management across a wide range of fields, including economics, law, psychology, sociology, information and communications technology, and building services management. There are many different models to be considered, not least in relation to the legal and cultural approaches of the particular country, but the concern for the management process now enjoys equal importance in most countries.

Key aspects of good management are: (1) selecting the right personnel for the job, (2) determining the work to be done, (3) deciding the way the work is to be accomplished, and (4) managing the relationship between the persons doing the work and the other elements of the museum. These activities may be accomplished either directly or indirectly, depending on the size and scope of the museum, but they are, however, fundamental to the management process. Museums in every country must address many of the same issues (or opportunities) regardless of the institution’s size, funding source, collections, or visitorship.

To better understand the museum management process, it may be important to gain greater insight into the way museums operate, and in particular who or what authorizes the museum and to whom do they report.

Different types of museums based on their authorising, managing and funding agencies or organisations:

1. Government - those museums that are established and run by local, regional, or national governmental agencies.
2. Private - museums funded and operated by individuals or private organisations, possibly for commercial profit
3. Museums of not-for-profit foundations, trusts and societies (known as “independent museums” in Britain)
4. University museums attached to colleges or universities and usually established and maintained for the educational purposes of the university, though many have an important public role as well.

The museums and similar facilities of religious organisations and establishments usually fall in group (3) above, except in those cases where they are the responsibility of a government ministry for religion or a State-financed religious body, in which case they are probably best regarded as government museums.

Management Structure

A crucial matter for management is to document the structure under which the museum is authorized, governed, and supported. This very basic process is valuable for existing as well as newly formed museums. Often the management structure is based on previous practices but lacks clear documentation. A simple diagram or organizational chart can be used to demonstrate lines of authority and information exchange.

Most museums have a management structure that includes at least three components - administration,

curation, and operations. All elements of the museum may be the responsibilities of one person, or they may accommodate many people. This tri-parted organizational structure allows distribution of various tasks. It can be expanded to facilitate increased activities while maintaining direct lines of communication and an easily

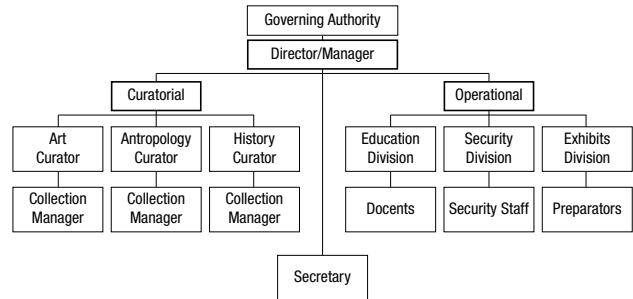

This simplified *hierarchical organizational structure* places the director/manager just below the governing authority and the rest of the museum staff below. The “top down” structure has few members of the staff reporting directly to the director/manager. There are only two persons in “middle” management positions.

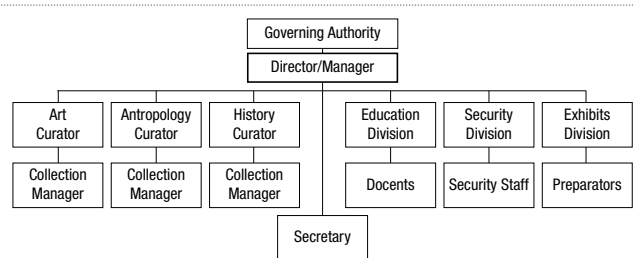

This simplified *horizontal organizational structure* places the director/manager just below the governing authority. It increases the number of staff having direct access to the director/manager, and consequently increases the number of persons in “middle” management positions.

comprehensible reporting procedure. Budget oversight, fund raising, and public relations, and marketing are often a part of institutional management reporting directly to the director/manager. The important issue is to have a clearly defined structure with established lines of communication. All members of the museum staff should know where they fit into the organisation, and a simple diagram can show their relationship to other staff members. The organizational chart is a map that defines the system and describes the flow of museum work, and demonstrates the organizational attitude toward the institution.

In the most common organizational structure, the governing authority is at the top with the director/manager immediately following. The rest of the staff is arranged below according to their relationship with the primary divisions of the museum. This arrangement is known as a *hierarchical structure* that can result in an authoritative or top down approach to institutional management. A second arrangement often called a *horizontal structure* spreads the line of contact with the director/manager to give all staff equal access.

A third alternative that is proving increasingly common is the *matrix structure*. Staff, particularly senior staff, are given both “vertical” responsibility for a particular academic or other professional specialisation and its staff as usual. But then in addition they have responsibility for managing a special theme which cuts across all or most of the museum and its staff structure, probably through an interdisciplinary internal working group or committee. For example the senior curator of archaeology, responsible for managing all archaeological staff, collections and services, might also lead a standing working group responsible for developing and maintaining the strategic development plan for the whole service, while the senior curator of natural history might have museum-wide responsibility under the

director for information and communication technology policy and its implementation.

Regardless of the details of the organisational arrangements, all elements ultimately converge on the director, who is the link between the governing authority and the staff. The actual structure will vary, but it should be clearly defined and care should be taken to involve staff in a range of decision-making roles. One way to promote this exchange is to have a management advisory committee. This will allow members of the staff to meet regularly with the director and other senior managers to discuss issues related to operational activities.

Teamwork

As already indicated, the museum management methods and structures tend to reflect the prevailing practices of national law, organisation, concepts of business, and levels of development. However, it is now widely recognised that regardless of these influences the organisational and management structure of the museum needs to promote a spirit of teamwork, open internal communication, and a generally accepted sense of purpose. Good museum management is therefore also about building teamwork, developing the institutional vision, and creating an environment where all staff members can work effectively and efficiently together in order to meet institutional goals. Team building extends far beyond the museum’s administration or personnel office. All managers, supervisors and leaders throughout the staff hierarchy have a very important responsibility to keep each person in their team involved and feeling appreciated, so they will willingly contribute their best efforts for the good of the museum. In short, every member of the staff should understand that they have a meaningful role in making the museum a successful contributor to the constituency it serves.

Beyond being good practice, teamwork encourages open communication and reduces misunderstandings. As a result, individuals work toward and accept new ideas. The potential for change is heightened, and institutional renewal is stimulated. There are many positive results of staff empowerment. An environment of openness and mutual respect is a hallmark of good management, and this must begin with the director himself or herself. In museums, as in all other areas of working life, when managers lose sight of the mission of the museum, and become obsessed instead with issues related to the organization as an entity separate from its purpose they, and their organisation, are probably heading for management failure.

A basic element of management and team building is trust, which is more than a notion of legal or ethical action. Trust is the foundation of positive relationships, both inside and outside the museum. It facilitates a sense of intellectual and emotional security based on mutual respect, honesty, and loyalty. Trust promotes open exchange, constructive assessment, and creative achievement. These elements influence the ability of a museum to accomplish its goals. A shared commitment to respecting individual qualities, maintaining open communication, and promoting the institutional mission is essential for a functional, forward thinking, and professionally oriented museum.

Public Responsibility

The museum should have as a part of its documentation, some form of written constitution, statute, or other document that states the museum's legal and financial status. It should confirm that the museum is not organised to make a profit for the benefit of the owners (except in the case of private museums), and that it is intended to serve the public need. The not-for-profit concept maintains the idea that any surplus income

LEADERSHIP STYLES OF DIRECTORS AND OTHER SENIOR STAFF

TRADITIONAL: "SOLO LEADER"

Plays an unlimited role: the Solo Leader interferes in everything

Aims for conformity: the Solo Leader tries to force all staff to agree with and adopt the leader's own ideas

The Solo Leader collects admirers and sycophants, and rejects anyone with new or different ideas of their own

Treats all staff as subordinates who must follow the Solo Leader without question

Lays down objectives: the Solo Leader makes it plain what everyone is expected to do and how they should do it

MODERN: "TEAM LEADER"

Chooses to limit the leader's own role to particular team roles: delegates the other necessary roles to others

Builds on the diversity of the staff: the Team Leader positively values differences between people and sees these as a strength of the organisation

Actively seeks talent within the organisation: the Team Leader does not feel threatened by people with special abilities

Understands that a key role is to develop and advance colleagues: the Team Leader encourages the growth of personal strengths

Creates a sense of mission for the organisation: the Team Leader projects the vision which others can act on as they see fit

(Adapted from the research of R.A. Belbin (1993). *Team Roles at Work* (London: Butterworth-Heinemann)

generated by the museum is used exclusively for the support of the institution and not for distribution to individual subscribers. (However, it has to be recognised that governments and civic authorities in many countries around the world regard all museum income as state revenue – in effect taxation – and still do not allow the museum to retain and reuse self-generated income from admission charges, publication sales etc.)

This idea of the not-for-profit nature of the museum seems simple, but the concept is sophisticated because it is based on the practice of philosophical ownership, which is a very important aspect of the nonprofit sector. The governing authority may change and the staff may change,

but the “public” as an ill-defined entity continues to “own” the museum as a holding place for cultural, natural, and scientific heritage. The stakeholders of the non-profit organization are the public, and the governing authority of the museum represents them. The governing authority, whether a governmental or other public body or the trustees of a non-governmental museum, has fiduciary responsibility for the museum. They can make decisions and determine programs, exhibitions, and collections, but should not receive benefits as individuals beyond knowing they have acted as good stewards and responsible trustees.

A particular challenge for a museum and therefore the director is to identify a coherent constituency served, usually though not necessarily its visitors, and then actively seek to involve that constituency as fully as possible in the museum development and activities. (See the Marketing and Visitor Services chapters). The museum’s constituency therefore has a major influence on the management and organisational structure of a museum.

Mission Statement

There may well be a general understanding of what is presumed to be the museum’s basic mission based perhaps on the name of the museum, the nature of its collections or the role assigned to it by the government or other governing authority. It can be assumed that fundamentally the mission of a history, art, or science museum is to deal with discipline-related objects. However, it is now widely recognised that the museum’s mission needs to be defined and published more explicitly, in the form of a Mission Statement, which among many other things will define the limitations of the collection and delineate the role and public identity of the institution. The mission statement should be simple but carefully written, describe what the museum is, what it does, how it operates, how it collects, where it operates, where it collects, and why it collects.

The mission statement should be reviewed regularly and when circumstances warrant, it can be updated, refined, or revised.

BUILDING A MISSION STATEMENT

The mission statement outlines the aims of the museum and might

- include a reference to your institution’s historic achievements and concern for responsibility
- define the purpose of the museum
- summarise the aims of the museum
- include a declaration or summary of the principles by which the museum proposes to operate.

EXERCISE: Working in small groups of perhaps four or five staff from different backgrounds and specialisms, draft proposals for a new Mission Statement for your museum. Some of the groups might be asked to take a more traditional approach to this, asking the questions who?, what?, when?, where?, and why? in relation to the purpose and mission of the museum as it is today. Other groups might be asked instead to consider a “vision” approach, looking at what the museum should become in the future. The different groups should then present each of the proposals to all the staff for wider discussion.

Though a mission statement is not normally a legal document, it is important for management and staff to acknowledge, endorse, and abide by the established mission of the museum.

Policies

A mission statement is a basic document for all museums as a declaration of purpose, but it is necessary to go

further than this, by considering and defining both operational policy statements and medium-to-long-term policy or development plans. Policies provide the framework for achieving the goals of the institution – its mission. Many of the institutional policies may well have been formulated externally, for example by the governing authority, such as the government or university in the case of government or university museums respectively.

Where there are special national laws and governing authority policies that apply to the museum, copies of these documents should be gathered together, for easy access, carefully studied and implemented by the museum board, director and relevant staff, according to their different responsibilities. Where there are such special laws etc. these will form the core of the museum's policy documentation, but even then there will be a need for clear statements of supplemental policies that address specific museum issues, 1) to define the framework for institutional decision-making, actions, and other matters, and 2) to define a course of action for the museum that is considered to be expedient, prudent, or advantageous.

There are three types of policies that museums should formulate:

1. Philosophical policies: which address ethical issues
2. Resource development policies: which guide the allocation of major resources,
3. Working procedures: which are concerned with operational matters.

In many organisations, the governing authority, hopefully in consultation with the director, has typically been largely responsible for generating the first and second types of policies, while the third is usually developed by the staff through consultation. However, nowadays in forward thinking museums, staff input into the policies regarding museum philosophy and ethics is regarded as essential, while decisions on the allocation of

financial and other resources without staff support may be counter-productive.

A good guiding principle is the modern concept of “subsidiarity” (already written into the European Union's fundamental constitutional treaties and to its employment charters that apply throughout its 25 member states). This insists that decision-making and responsibility should always be delegated to the lowest possible level within any government or employment hierarchy. If policies are designed to meet specific needs, then the persons most qualified to identify and take responsibility for those needs are the individuals with the most detailed knowledge of the organization – the staff concerned. It is also very important to ensure that both procedures and internal attitudes make sure that policy recommendations may emanate from staff at any level of the organisation: the director and heads of curatorial and academic departments are not the only people to have good ideas about the museum's operations and way forward.

Financial Management

Most museums are subject to national financial and accounting laws and control to a great extent, and to a governing authority that determines the financial practices of the institution within these legal constraints. The authority may differ and the level of financial oversight may differ, but few museums have complete and unrestricted control over all aspects of their finances. Regardless of the level of flexibility or the source of funding, all museums have an obligation to be accountable for the money allocated to them. The process of budget development, fund accountability, and financial planning is generally described as financial management, and while the guidelines may be carefully structured by the governing authority, the implementation rests with the museum director/manager and subsequently with the staff.

Developing policy statements and eventually a policy manual

Policies are essential to good management, and it is important to establish sound policy documents that reflect the values and beliefs of the museum, the expectations of staff, collections care and use, fiscal matters, physical plant use, and other issues that directly impact upon the ability of the museum to fulfil its mission. Well-defined policies help management and staff make proper decisions and outline the framework within which they can operate.

Furthermore, policies, and publicly available documents reassure the public that an institution has given careful consideration to its actions.

Museum policies may cover a number of issues. The following are examples of topics that are often defined by policies:

1. Acquisition
2. Accessioning
3. Deaccessioning
4. Collection care and use
5. Loans
6. Exhibits
7. Public programming and education
8. Human resources
9. Financial resources
10. Staff evaluation
11. Health and safety of staff and visitors
12. Facility (premises) maintenance
13. Facility (premises) use
14. Natural disasters and hazards

EXERCISE:

Additional policies may be required to meet the specific needs of a particular museum. Together with the mission statement, the policies and procedures define the levels of accountability the museum has for the collections and the public it serves.

1. In relation to your museum, which of the areas of policy in the checklist above have no policy statement or document at the present time?
2. Are all the current policy documents for those areas that are already covered up to date, or do they need revising?
3. Are there any special aspects of your museum's work or responsibilities which are not covered by the checklist, which ought to have a policy statement or document?

Financial requirements and regulations

Museum staff with responsibility for financial policy and control need a working knowledge of the law and the financial regulations that apply to the museum, to their work within it, and to any special finance or public service laws or rules applying to the conduct of the museum staff (e.g. anti-corruption measures such as restrictions on accepting gifts or favours). In addition there may be some special laws or rules about issues such as:

1. the use of income for ticket sales
2. the use of income from the museum shop
3. items that may be sold in the museum shop
4. pay (compensation) for workers
5. providing medical and/or social security insurance and services for staff
6. taxation
7. purchasing and accounting processes
8. corrupt practices and conflicts of interest

EXERCISE:

Find out which are the key financial laws and regulations applying to the museum and the work of its staff, and create a list and brief summary of these, together with a folder readily available to all staff containing copies of these.

Financial management is viewed by many as one of the most difficult aspects of museum management – something to be left to the accountants or bookkeepers in the museum's administrative offices or perhaps the Ministry. In reality it is essential that all staff helping to prepare budgets or control projects and expenditure have an understanding of both financial principles and practical budgeting and expenditure control, and both the budget document and the internal financial control procedures need to be simple and usable.

In the simplest terms, an annual budget is a management tool and planning document stated in

money terms. However, budgeting is more than a matter of balancing expected revenue income with expenditures. It indicates the money expected to be available from the various sources (government grants, admission charges, trading, donations and sponsorship), the money needed (for continuing operations - by projection, and for planned improvements or other changes according to the development plan for the year), and the difference between the two. The budget also allows management to determine the most appropriate alternatives for the allocation of resources, whether for new developments or as a result of changes in policies or priorities. The budget is therefore a statement of intent that is used to guide an institution's activities and which empowers the museum's management to decide how to use financial resources most effectively.

The relationship between the mission-oriented goals and financial resources is critical, and budget formulation must be seen as an integral part of the planning and management process. As an instrument of managerial control, once the budget year commences, the budget is used to track actual spending and receipts against planned targets. Signs of differences between expenditures and the projected budget may signal the need to slow spending or increase income, or to shift resources from one category or financial commitment to another. Differences in spending or in revenues that amount to more than incidental departures from the planned amounts require senior management's attention. Also, in these circumstances it may well be that an early report to the governing authority will be required, since in most administrative systems, whether governmental or not-for-profit nongovernmental, the director or other budget manager and controller is forbidden to spend more than the amounts authorised without the approval of the Ministry, Board or governing or regulating body.

Most museums receive income from different sources. Often the primary support comes from the government, but even in that case, additional income may come from admission charges, the gift shop, donations, or food service, though in very many countries government and civic museums and similar cultural bodies are still not allowed to keep their admission charges or any other income that they earn, but are instead required to pay everything over immediately to the finance ministry or town hall.

In the case of museums outside direct government control, or where traditional government regulations have been changed, museums may have several self-financing opportunities, such as:

1. Admission charges
2. Gift shop
3. Food service
4. Marketing
5. Tourism facilities and services
6. Voluntary contributions
7. Corporate sponsorships
8. Consolidation and merger
9. Publishing
10. Fees for travel company tours

These days, most museums seem to be facing financing challenges, particularly reductions in governmental subsidies and ever increasing operating costs. This situation may change, increase, or decrease depending on the museum and the host country, government, or organisation.

The accounting system used by the museum will undoubtedly reflect the requirements of the governing authority. The process should identify whether specific funds are restricted, that is, to be used only for specific purposes, or unrestricted, allowing greater flexibility and decision-making by the museum director/manager and staff.

The museum's *operating budget* deals with the day-to-day financial activities of the museum over the approved

accounting period (normally a continuous period of 12 months – usually linked to the national or governmental accounting and tax year). This allocation or allotment may be based on the expenses of the previous year or determined by the museum's activities. It is prepared annually for showing expected revenues and expenses for the current year. It reflects the relationship between anticipated income and projected expenses. Though in determining the overall operating budget for the coming year the governing authority may lay down the amounts or proportions to be allocated to certain categories of expenditure, a measure of management level decision-making generally remains, affording the director much flexibility within these limits.

The normal museum budget usually details all the authorised expenditures (and any revenue income targets) of the organisation, and thus the organisation's entire financial picture. In contrast with this a *project budget* relates only to a particular project or activity, usually of limited duration, ranging from a major building scheme, through to a temporary exhibition or other special event.

When they are written and approved, budgets are developed as "*projections*" (or "forecasts"), usually based on the best estimates of museum management using past records. After the money is spent or received, the final accounts are re-defined as "*actuals*". Projections are made when the budget is being developed, and actuals are the result of accounting for the funds received and expended, when the project is completed, or at the end of the budget year, when the actual expenditure may be the same as the projection, though the two may be different. Some government and other accounting systems and rules permit in certain conditions the movement of funds from one account to another (often referred to as "virement") to meet the requirements of the museum, but other systems do not allow that flexibility.

It is important to understand that budgeting must be an on-going process, not something done once a year and ignored the rest of the time. A budget is a working document that should be reviewed monthly by the director, other appropriate staff members such as departmental heads, and (probably) members of the museum's governing authority. This scrutiny is important because neither income nor expense can be predicted with total accuracy. Regular review is the only way museum management can know where it stands financially in time to make necessary controls on expenditure or projects. For effective budget comparisons between years the financial or fiscal year should remain the same unless there are compelling reasons to change.

Six rules for planning a budget:

1. Be specific in making projections.
2. Do not be too optimistic in your projections.
3. Make the budget realistic.
4. Establish minimum internal budgets.
5. Distinguish between fixed costs (e.g. permanent staff, building costs, services) and programme or special project budgets.
6. Do not underestimate overhead expenses.

A "Balance Sheet" for a museum is a statement of the overall financial position on a specific date, detailing among other things all of the organisation's financial assets, such as money in the bank, the value of premises and equipment, together with details of what the museum owes on that date, such as any loans and unpaid bills. Though a model very familiar from the world of business, in a growing number of countries, governments and the regulatory authorities for not-for-profit bodies now require government departments and services and non-

governmental bodies to adopt business accounting systems and rules including the preparation and publication of an annual balance sheet and financial report.

Museum Ethics and Management

There are a number of ethical issues that relate to the museum's policy, management and particularly its use of money and other resources, not least its collections. Certainly, there are national laws addressing accountability, however the issue of ethical responsibility is not limited by national or political boundaries. In order to meet accepted standards of institutional ethics, every museum should have a financial management policy that among other things defines who has authority to expend institutional funds, the nature of materials or objects that can be purchased, and the method of budgetary oversight. Records should be kept of all expenditures, funding sources, and every adjustment to the budget. Regular reports of the institution's financial status should be made available to the proper authorities. An open (transparent) budgeting process is the best way to avoid problems and suspicions.

A museum's public responsibility revolves around the ethical correctness of its activities including the care and use of collections, as well as proper institutional management. Ethical responsibility is evidenced by interaction inside and outside the organization and the way a museum conducts its activities. An ethical museum is one in which all participants acknowledge the core values and where those values are defined in the context of the museum's mission.

Planning

Effective museum planning should be a holistic activity that takes a large view of the museum's history, mission, collections, staff, facilities, funding, community support,

Planning I - The planning process

In the simplest terms, a museum needs to plan to reaffirm or to modify its mission — why it exists, what its purpose is, and what it does, and to agree on its vision – where it wants to be and what it wants to do in the coming years. The ultimate product of the planning process is a guide to govern the activities of the museum. It is not the purpose of the plan to decide what should be done in the future, but to decide what should be done now to make desired things happen in the future.

Planning is likely to include some or all of the following:

1. **Financial Planning:** These are issues related to the current and future funding needs of the museum and its ability to secure sufficient resources to support activities for the execution of its stated mission.
2. **Community Needs and Involvement:** Planning for the changing needs of the community to enable the museum to develop effective responses appropriate to its mission and priorities.
3. **Human Resources Planning:** These issues concern the recruitment, training, and retaining of sufficient qualified personnel with adequately diverse backgrounds to fulfill staff and volunteer service needs.
4. **Organisational/Structural:** These issues evaluate the museum structure to determine the best configuration to meet current and future museum and community needs through the provision of quality, cost-effective services.
5. **Communications/Marketing/Visibility:** These issues ask how the museum can make itself more visible and inform the public about its mission and services, and consider what resources will be needed to execute the processes of gaining greater visibility.
6. **Contribution to National Agendas:** Whether or not the museum is part of a national museums or antiquities service, the museum's institutional agenda should support increased awareness and advocacy of national issues such as conservation, funding, accountability, and standards.
7. **Service Effectiveness:** These issues relate to evaluation of services, programs, and exhibits and the results, to measure museum effectiveness in meeting the needs of targeted populations, and ensuring that marginal services will be enhanced or discontinued.

Planning – II – issues to be considered:

Elements of the museum that should be considered in the planning process:

- Mission
- Organization
- Decision making
- Fund raising
- Resource allocation
- Performance evaluation
- Organisational effectiveness

Evaluation

The final stage in the planning process is self-evaluation. It is an important way to determine the effectiveness of the museum and a valuable method for deciding the value or purpose of the institutional mission. Having established its goals through its planning process the museum needs to develop strategies for achieving and evaluating those goals and objectives.

For example, an institutional self-evaluation should aim to help the museum and its staff to:

- Identify needs in society
- Define its relation to the mission of the museum
- Evaluate its capabilities as a museum
- Assess its external environment
- Set objectives for the museum
- Select strategies for the museum
- Design curatorial, exhibition, educational and other public programmes for the museum
- Determine a future budget for the museum
- Evaluate the overall performance of the museum

SWOT Analysis

One of the methods for analyzing the institutional assets is called SWOT. This process is not an end unto itself, but a method for gathering information to be used in the planning process. This technique calls for an examination of the institution's:

- **S**trengths
- **W**eaknesses
- **O**pportunities
- **T**hreats

EXERCISE:

Meeting in small groups of staff, share ideas about the museum and consider them in the four categories.

audience, political status, local and regional threats, and other environmental and social potentialities in making decisions that will guide the museum into the future. This planning process allows the museum to assess, redefine, and implement its mission, programming and exhibitions, and the audience served. There is a close link between the planning process and marketing because the planning must precede the marketing, and the marketing analysis of a museum is a part of the planning process.

Planning helps develop successful management as a basis for strong governance by the supervising authority, sound management by the director and staff, effective funding and utilisation, and developing constructive programme evaluation by all participants in assessing the effectiveness of the museum in fulfilling its mission. Every museum in the world can be improved, and effective planning is an important part of the quality assurance and continuing improvement process.

Without a continuous programme of planning and evaluation, the museum's effort may well be haphazard with unpredictable outcomes. Planning should focus on achieving the most appropriate "fit" between an organization and the environment in which it operates. In this context the environment means those conditions that exist both inside and outside of the organization that influence its operations.

Concluding Comments

Employment by a museum is a public trust involving great responsibility, and the roles of the senior management including the director are among the least well-defined responsibilities in the contemporary museum. This ambiguity is due to the wide range of managerial duties that include various museum activities as well as the technological, political, and social capabilities that are necessary to guide the museum in uncertain and demanding times. The director must be a public representative, service advocate, and museum professional all at the same time, and also be capable of securing essential resources for the museum while maintaining the integrity of the institution. He or she needs the scholarly and administrative skills to promote the mission of the museum, as well as excellent communication skills, particularly the ability to explain both major and minor but critical issues that may not be understood by the public.

The management process for a museum is often challenging but always rewarding for those persons committed to serving the interests of the public, protecting the commonwealth of the people, and promoting goodwill and understanding. Good management is about institutional sustainability, professional ethics, respect, loyalty, honesty, and dedication. Museum directors and all other professional

To be a successful leader of the institution, the museum director should keep the following key points:

1. envision institutional goals
2. affirm institutional values
3. motivate the staff
4. manage institutional responsibilities
5. achieve workable unity
6. explain challenges and opportunities
7. serve as a symbol,
8. represent the museum and group externally, and
9. renew staff and institutional commitments

and administrative staff with managerial responsibilities must perform their duties with integrity and in accordance with the most stringent ethical principles as well as the highest standards of objectivity.

Managing People

Patrick J. Boylean

Professor Emeritus, City University London

Museum personnel: the key to museum effectiveness

The employees of the museum, whether paid or volunteer, are the institution's most vital asset. Regardless of the importance of the collections, without the museum staff who curate and conserve the collections and display or otherwise make these available to their public, even the museum's most important treasures will be of little real value or use, while without proper preventive conservation (as a very minimum) the collections will almost certainly deteriorate until they could eventually be totally lost.

Similarly, while good security arrangements are very likely to involve the use of both physical and electronic barriers and devices, these also depend on effective staffing for their proper operation and monitoring. Larger museums, at least, also need a wide range of administrative and other professional and support staff to work in important areas such as buildings, financial and human resources (personnel) management, exhibition and design work, and in marketing and public relations.

Understanding personnel management

Even where specialist personnel or human resources managers are employed by the museum it is essential that all the more senior staff of the museum should also understand both the fundamentals of good personnel management and leadership. This should be a requirement for directors and heads of department and section heads

responsible for supervising other staff. In particular, since the great majority of personnel management decisions are made at the "front line" by professional and supervisory staff who are not personnel specialists, all senior and middle level staff regardless of their specialisations and main duties need to have a reasonable understanding of the museum's official personnel procedures and any relevant national law.

Also, every member of staff has the right to understand their own terms and conditions of employment, together with any general staff rules. As far as possible all of these should be written in simple language, and copies should be easily available for employees to consult at any time.

The other chapters of this *Handbook* seek to present "best practice" guidance that is relevant to almost any museum or similar institution anywhere in the world. In contrast with this, however, the personnel principles, rules and procedures adopted by a museum, including employment contract terms and working conditions, will usually have to be based closely on the national laws and regulations of the country relating to employment, together with the employment principles and rules of the employing ministry or other governing authority in the case of public museums and related bodies.

It is important to recognise that there can be major differences in these laws and rules from country to country. Even several decades or more after the end of colonisation strong differences based on the legal systems and traditions of the former colonial or mandate powers often still survive in the different national legal systems and in the principles

and rules of both general employment, and especially those relating to public services.

Big differences between traditions of employment and contract law, and therefore in personnel management practice and rules still persist between countries with a Civil Law (Roman Law) tradition developed under former French administrations, as in Algeria, Lebanon, Syria or Tunisia, compared with those of the English Common Law systems of former British colonies and mandated territories, such as Iraq, Jordan, most of the Gulf States or Israel and Palestine.

PRACTICAL EXERCISE TO IDENTIFY KEY FACTORS IN RELATION TO EMPLOYMENT TERMS AND CONDITIONS

1. Prepare a list of the main national laws and rules governing employment terms and conditions in the country
2. If yours is a public museum, also summarise the main government regulations or agreements controlling employment conditions for your institution
3. In addition to these do you have a Staff Handbook or Staff Agreement setting out the detailed employment procedures and conditions?

The main categories of museum work and museum employees

Again, national traditions play a major part in determining the nature and range of jobs found in a museum. In some traditions there will still be only a very narrow range of museum employees, with just two predominant categories: highly educated specialists working primarily with the specialist collections or research programmes of the museum – what have been termed “scholar-curators” – and the security, building maintenance and other support staff.

However, in other museum traditions, perhaps even in apparently very similar countries or museums, there can be a very diverse range of specialist staff, covering perhaps twenty or more specialist professions. These other specialisms include scientific conservation and restoration, field research, documentation, education and interpretation, and visitor services specialist personnel, together with a wide range of specialists in a range of managerial, administrative and financial duties. (See also the section on organisational structures in the *Management* chapter of this *Handbook*).

A good indication of the potential range and diversity of the museum profession today is seen in the list of specialised branches of the profession recognised by the International Council of Museums (ICOM) and its International Committees (see Box 2).

Personnel information, involvement and fairness

While each type of museum employee will require experience or training relating to their specific role and duties there is some basic information and understanding that apply to all staff. (See Box 3).

However, successful staff management requires much more than good leadership from the Director and proper management of employment procedures by specialist Human Resources or Personnel Officers. There needs to be a strong understanding of, and commitment to, good employee relations and fair treatment of all employees by all staff at every level of responsibility. This has been shown by a great deal of independent survey research on what creates and maintains an effective organisation and good staff relations, (see Box 4):

Recruiting and retaining high quality staff

Fair and equal staff management procedures are both a practical necessity and an ethical obligation. Fairness must

BOX 2:

THE MAIN SPECIALISED BRANCHES OF THE MUSEUM PROFESSION FOUND IN ICOM'S VARIOUS SPECIALIST INTERNATIONAL COMMITTEES

1. Museum directors and chief executives
2. Curators working with specific types of museum or museum collections (ICOM recognises International Committees and Affiliated Organisations covering no less than 25 such specialisations)
3. Conservator-restorers and other specialised technical personnel
4. Registrars and other documentation specialists
5. Museum teachers and other education, communication and community liaison staff;
6. Museum-based researchers including field archaeologists, ecologists, geologists, ethnographers, social historians and other external fieldwork staff
7. Museum architects, designers and interpreters
8. Exhibition personnel
9. Audiovisual and new technologies specialists
10. Museum librarians, archivists, documentation and information specialists
11. Museum security specialists
12. General and specialised management and administration personnel, including those responsible for financial, personnel, legal and buildings management
13. Public relations, marketing and other commercial activities
14. Staff training personnel, including the museum training officers and the teaching staff of museological training institutions

begin with a clear commitment to equality of opportunity, which ought to be expressed in a written Equal Opportunities Policy, which should cover equality and fairness in recruitment, promotion, day-to-day supervision and management, pay and other benefits, pension rights, and the training opportunities. This policy should require the use of agreed procedures in relation to all stages of the recruitment of a new member of staff, or in considering an application for promotion within the Museum.

BOX 3:

BASIC INFORMATION ALL STAFF SHOULD UNDERSTAND REGARDLESS OF THEIR JOB OR SENIORITY

ICOM's Training of Personnel Committee has advised museums to ensure that every individual museum worker understands the museum's role in society, and their own roles in the particular institution. It is recommended that the initial training or briefing for newly recruited staff should explain the significance of employee's work in relation to the overall aims and programme of the museum. The aim should be to ensure that, in relation to their own job, every employee should be able to answer the following questions as they apply to their own museum:

1. **Museums:** why do we have them and what is their function in society?
2. **Collections:** how do we get them, how do we study them and care for them, and what do we do with them?
3. **Museum organisation:** who does what in the museum and how do they do it?
4. **The museum and its public services:** why do we provide them, how do we organise them, and how are they used?
5. **Physical facilities:** how do we provide maximum access to museum facilities while safeguarding the collections?

Once a staffing structure has been agreed for the museum (see the *Management* chapter), each staff position needs to be properly analysed in order to create a Job Description for each post which tells both those applying for a vacancy and all existing staff what are the key features of the job, including purpose, conditions of employment, key tasks and main responsibilities. After the Job Description has been agreed there should be a further analysis of what qualifications, skills and

BOX 4:

CORPORATE HEALTH AND EFFECTIVENESS

Management researcher Brian O'Neill (*Professional Manager* January 1993) has found that to be successful and effective an organisation needs the following:

1. A common sense of direction and purpose
2. Well-designed jobs
3. Staff who feel they are being treated fairly, with their value properly recognised and appreciated
4. A participative style of management
5. Everyone to be kept informed of plans and events
6. Each employee should feel a valued member of a team
7. Well-designed working places and facilities
8. A shared understanding of roles
9. Everyone to be trained for the job
10. Fair opportunity for promotion
11. Leaders and supervisors who visibly show they care and are supporting
12. Staff being involved in planning change from the beginning
13. Opportunities for staff to use their skills
14. Opportunities for staff to contribute ideas.

EXERCISE: Working in small groups, discuss frankly the present state of your own museum or other organisation (e.g. Section of a Ministry), using this checklist and identify at least five priority areas for improvement.

experience are needed in order to be able to do the job: this is called the Person Specification. The Job Description and Person Specification are very important, since together they should be the key to the selection procedure that follows.

The Person Specification in particular should be used to assess and score each person applying for the vacancy position or promotion, and will therefore be the basis of

the final offer of appointment. Examples of Job Descriptions and Person Specifications for two typical museum positions are shown below (a senior curator position in Box 5 and a conservation officer in Box 6).

It is then necessary to decide how to assess the applications received against the Person Specification. A wide range of assessment methods are in use across the world (see Box 7) and it is necessary to agree in advance which combination of these should be used in any particular case.

Once the successful candidate has been chosen and has accepted, the appointment needs to be confirmed in writing. In some countries this will involve the drawing up and signing of a formal contract of employment in a particular form laid down by law. In other countries a less formal procedure is acceptable. Either way, it is important to ensure that both the employer and the new or promoted employee agree on the terms and responsibilities of employment. As a minimum, the agreed written statement should include the basic information set out in Box 9.

However, the recruitment process does not finish when the new employee starts work, or when someone takes up their new position after promotion. It is most important that whoever is responsible for the personnel function, whether a specialist human resources manager, a general administrator, or perhaps the director, follows up the appointment with a planned programme of initial training to introduce the new person to their duties and responsibilities, and to ensure that any necessary additional training, whether formal or informal, is provided without delay.

It is also very desirable that, in addition to support from Personnel, the new employee also has a nominated member of the professional or technical staff within their own area of expertise to act as a "mentor" or guide and

BOX 5: SAMPLE JOB DESCRIPTION – I

JOB TITLE :Conservation Officer

NORMAL WORKING BASE :Regional Museum Conservation Centre Annexe

GRADE (SALARY AND WORKING CONDITIONS) : .National Civil Service Grade Y

RESPONSIBLE TO :Collections Manager

RESPONSIBLE FOR :4 members of staff (2 Assistant Curators, Conservator, Documentation and Clerical Assistant), plus students and volunteers from time to time

JOB PURPOSE :Responsible for the conservation and appropriate documentation of the Service's collections; support for conservation in other relevant areas of the Service; store development and management, including monitoring of environmental variables; Health and Safety legislation and procedures; Emergency Planning for the Service; management of the Section.

JOB ACTIVITIES :

1. Customer Services

- a) Ensures that the needs of customers are determined, provided for and reviewed according to agreed procedures and including the special needs of people with disabilities.
- b) Manages and develops the advisory work of the Section in relation to collection and information sources in response to enquiries from a wide range of customers.
- c) Manages and develops a wide-ranging interpretative programme targeted on the needs of the customers, the Service and other associated organisations, utilising the available resources to their best advantage.
- d) Oversees access to the use of collections and information resources by customers of all kinds through on-line (Web) systems, loans, visits and other means.
- e) Contributes to visitor services initiatives as appropriate.
- f) Maintains statistics on the use of object and information resources and enquiries generally.

2. Maintains the Resource Base

- a) Responsible for the acquisition, preparation, conservation and documentation of specimens relating to the defined subject and collecting area, and maintaining these collections in appropriate condition for their well-being and for customer access.
- b) Responsible for the collection, storage, interpretation and evaluation of information relating to the museum's agreed geographical territory through fieldwork, research and other programmes.
- c) Represents the interest of the Museum on a variety of local and national forums and in government enquiries as the need arises.

- d) Develops fieldwork programmes in conjunction with other relevant parts of the Museum and the government service.
- e) Manages the Section library.
- f) Produces fully researched texts relating to the subject and the collections for internal and external publication.

3. Management Functions

- a) Plans and organises the work of the section, ensuring work programmes are completed to agreed schedules and outputs are achieved.
- b) Contributes to the Service's Annual Plan.
- c) Manages delegated budgets according to Departmental requirements.
- d) Participates in the management of the Service generally and takes responsibility for projects and initiatives as determined by the Management Team.
- e) Arranges Section meetings and other team meetings as appropriate to the effective working of the Section and the Service.
- f) Manages the staff of the section and, as appropriate, including contract staff, student placements, volunteers and specialists from other organisations.
- g) Assists in managing any relevant joint arrangements with other organisations that are agreed from time to time, and contributes as necessary to their specification and costing.
- h) Contributes to income generation for the Service as appropriate.
- i) Supports and contributes to appropriate training programmes.
- j) Supports the Service's quality assurance initiatives and encourage staff involvement.
- k) Any other duties commensurate with the grade of the post as instructed by the Director or Assistant Director.

BOX 5: continued. PERSONNEL SPECIFICATION FOR SELECTION AND APPOINTMENT

Attributes Sought

Essential requirements

Desirable in addition :

1. Experience

- Curatorial practice in the subject area
- Use of Information technology
- Strategic planning experience
- Established publication record
- Field research experience
- National/Local knowledge
- Experience of answering enquiries from the public
- Liaison with national and international organisations
- Interpretative programmes.
- Quality initiatives experience
- Experience in preparing project budgets and grant applications

2. Qualifications

- University degree in a relevant academic discipline
- Postgraduate degree
- Museology or equivalent postgraduate qualification or training

3. Motivation

- Committed to the job and to the aims of the Museum
- Must be able to take a strategic view

4. Attitude & Temperament

- Must be a good team worker
- Organisational and leadership skills
- Good communicator, both verbally and in writing, and with a wide range of people
- Works methodically and takes care of details
- Able to chair and participate effectively in meetings

5. Appearance & Health

- Reasonably fit: able to undertake relevant fieldwork in the subject
- Normal health: with some adjustment a person with some disabilities would be able to do the job

6. Special requirements

- None
- Current driving licence would be useful

(Date prepared/last revised: xx/xx/200x)

BOX 6: SAMPLE JOB DESCRIPTION – II

JOB TITLE :Conservation Officer

BASE :Regional Museum Conservation Centre Annexe

GRADE (SALARY AND WORKING CONDITIONS) : .National Civil Service Grade Y.

RESPONSIBLE TO :Collections Manager

RESPONSIBLE FOR :One Technician, plus students and volunteers from time to time

JOB PURPOSE :Responsible for the conservation and appropriate documentation of the Service's collections; support for conservation in other relevant areas of the Service; store development and management, including monitoring of environmental variables; Health and Safety legislation and procedures; Emergency Planning for the Service; management of the Section.

JOB ACTIVITIES :

1. Advisory and Liaison Work

- a) Advises on matters relating to conservation, including proper care, preparation, conservation, storage and display of all items permanently and temporarily in the care of the Service.
- b) Advises on matters relating to conservation, including the proper care, preparation, conservation, storage and display of museum objects in general.
- c) Liaises with other specialist conservation staff, both internal and external, on general conservation matters.
- d) Liaises with other conservation staff, and the staff of other Sections, as appropriate, on matters of environmental monitoring and control.
- e) Liaises with external specialists, obtaining and exchanging information and advice on matters relating to conservation.
- f) Liaises with suppliers and contractors as appropriate.
- g) Answer enquiries on conservation matters from customers and Service users of all kinds.

2. Monitoring of Specimens and Environment

- a) Specifies, plans, orders and manages the installation of environmental monitoring and control equipment in stores and display areas.
- b) Monitors the performance of all relevant environmental control systems and liaises with contractors and suppliers on maintenance matters.
- c) Monitors the condition of all specimens permanently and temporarily in the care of the Service.
- d) Maintains an overview of storage facilities and requirements for the Service as a whole.

3. Treatment of Specimens

- a) Carries out diagnosis of, and records, the condition of all specimens requiring, or submitted for, conservation or related treatments.
- b) Determines the appropriate conservation or related treatments required

by specimens.

- c) Carries out, or commissions for outside experts when appropriate, the necessary conservation or related treatments.
- d) Records all treatment applied.
- e) Manages the Service's requirements for conservation work, maintaining a work programme and reporting on progress.

4. Other Duties

- a) Maintains inventories of equipment, and of other conservation-related stocks of chemicals and other consumables as required.
- b) Manages the implementation of Health and Safety Regulations across the Service.
- c) Maintains stocks of chemicals, consumables, storage items and equipment for conservation and collections management, and proper records of these for both safety and audit purposes.
- d) Organises and maintains workspaces, stores and displays as required.
- e) Ensures that expenditure on stocks is within budget; keeps records of such expenditure as required.
- f) Writes reports, papers or articles for internal use, publication or communication on specimen conservation and related matters as required.
- g) Provides, with others, professional training and information exchange in the field of conservation as appropriate.
 - i) Contributes to income generation for the Service as appropriate.
 - j) Services any relevant joint arrangements; contributes as necessary to their specification and costing.
- k) Undergoes specialist training, as the need arises, in order to carry out specific conservation functions.
- l) Any other duties commensurate with the grade of the post as directed by the Director or Collections Manager.

BOX 6: continued. PERSONNEL SPECIFICATION

Attributes Sought

Essential requirements

Desirable in addition :

1. Experience

- Specimen conservation.
- Documentation of processes.
- Environmental monitoring.
- Preparing objects for display.
- Management of collections storage.
- Environmental control and monitoring systems.
- Computer literacy.

2. Qualifications

- Relevant degree or degree level diploma in conservation or relevant experience.

3. Motivation

- Commitment.
- Must work on own initiative.

4. Attitude & Temperament

- Team worker.
- Organisational skills.
- Methodical approach.
- Good communicator – literate and articulate.
- Interest in broad conservation issues.
- Interest in new conservation techniques and in information technology.

5. Appearance & Health

- Normal health
- Must be able to lift and move medium-heavy objects safely. Some disabilities could be accommodated but good vision (including colour vision) and lifting strength is essential

6. Special requirements

- Current valid driving licence.

(Date prepared/last revised: xx/xx/200x)

BOX 7:

EXERCISE

Analyse one existing job within the Museum and prepare both a Job Description and a Person Specification for this.

advisor during their first few months in their new position. There should also be a formal review of each new appointment after a new months, including an informal interview with the employee, to make sure that all is going well, and that there are no hidden problems.

Recruiting a new member of staff is a very costly exercise in terms of time, and perhaps financially also if there are advertising and similar costs to pay. Inevitably there will be a period of perhaps several months during which the new employee is still finding their way before they reach their maximum potential and performance in the new job. High staff turnover is both wasteful and often a sign that there could be serious problems in the way that the museum is being managed and operated.

Continued from page 150

BOX 8:

**RECRUITMENT AND PROMOTION SELECTION
METHODS AND APPROACHES**

1. **Short-listing candidates**
2. **Rejecting and recording candidates who are not short-listed**
3. **Information-gathering process:**
 1. group briefings, visits etc.
 2. individual briefings, visits etc.
 3. observed (or led) discussion groups among candidates
 4. individual or group projects: practical exercises; management games etc.
 5. one-to-one interviews
 6. panel interviews
 7. testing: psychometric, psychological, physical, specialised aptitude tests etc.
 8. inspection of portfolio of work, documentation of evidence of competences etc.
 9. other testing, e.g. graphology
10. **Interview techniques: especially questioning**
 - a. "closed" questions - fact gathering & checking
 - b. standardised "open" (e.g. problem-solving) questions asked of all candidates
 - c. other "open" questions
 - d. information exchange - candidate's questions etc.
4. **Choosing the successful candidate on the basis of the Person Specifications, and negotiating final terms and conditions (e.g. commencing salary, starting date)**
5. **Notifying unsuccessful candidates**

Consequently, every effort needs to be made to retain good staff once they have been recruited. The director and other senior staff, including the human resources specialists, need to ensure that both new and longer-serving staff feel comfortable and valued in their role so that they are happy to stay with the institution for the long term.

BOX 9:

**MINIMUM REQUIREMENTS FOR A STATEMENT OR
CONTRACT OF THE TERMS OF EMPLOYMENT**

1. Name and address of employer
2. Name of employee
3. Job title (or short description)
4. Date of commencement of appointment
5. Date on which employment ends (if for a fixed term)
6. Details of pay: initial pay rate, period and method of payment, also how pay is calculated or reviewed (e.g. by reference to an official or government pay scale or a trade union negotiated collective agreement)
7. Details of the normal hours of work and related conditions (e.g. reference to collective agreement on flexible working hours)
8. Arrangements for holidays and holiday pay
9. Arrangements relating to incapacity for work due to sickness or injury including any sick pay rights etc.
10. Terms and conditions relating to pension arrangements
11. Length of notice due to and from the employee
12. Information on disciplinary and grievance rules and procedures
13. Rights and conditions relating to trade union recognition (if applicable)
14. Full details of where employees can consult official documents relating to the employment (e.g. collective agreements on pay and conditions, disciplinary and grievance codes etc.).

**Staff management, training and professional
development**

It is generally accepted these days that in order to ensure effective operation and service there need to be regular reviews – and ideally objective measures – of the performance of both the institution overall, and of individual staff within this, though there is so far no generally accepted standard or procedure for this within the museum sector. This is too specialised a topic to be covered in detail in a general over-view such as this, but there is a growing body of case studies which could be looked at. For example, the government funds of each of the English national museums and galleries under the

Department of Culture, Media and Sport now operates on a formal three year funding contract which incorporates in each case explicit performance measures and provision for the publication of annual performance reviews of these, while the American Association for State and Local History (AASLH) is developing a model scheme for use by its (mainly small) member museums and historic sites.

Staff training and development is also a very important part of the continuing personnel management process. Since 1986 ICOM has insisted, through its Code of Professional Ethics, that staff training and retraining is an important ethical issue for both the institution and for the individual museum professional. In the present rapidly changing world it is no longer acceptable for a professional, technician or administrator to undertake training and gain qualifications at the beginning of their careers, when they are probably still only in their 20s, and then rely on this training for another thirty or forty years. Very many professions are now strongly committed to the concept of Continuing Professional Development (CPD) under which, in order to retain professional status and recognition, the professional must undertake a significant amount of formal additional training or retraining within a given period.

For example, the UK-based Museums Association now awards its highly regarded professional Associateship and Fellowship for only five years at a time, rather than for life as used to be the case. Each member is then required to keep a record of all their formal training and informal staff development activities, such as attendance at professional meetings or undertaking some new professional or management activity, for discussion and review before their qualification or professional status is renewed.

ICOM also offers guidance on the minimum specialist and general knowledge and competence standards for museum work in the *Curricula Guidelines for Museum*

Professional Development (latest edition 2000) which covers five broad areas of competencies—general descriptions of knowledge, skills and abilities (KSA's) needed to work effectively in today's museums. The ICOM *Curricula Guidelines* "tree" model shown below (Box 10) aims to illustrate the shared and functional competencies required by museum workers in order to understand and perform their jobs properly. The shared "General" and "Museology" competencies, which it is considered that all professional museum workers should possess, are shown as the roots and trunk of the tree of competencies. The three major areas of functional competencies identified as those needed to perform specific key activities within museums, i.e. "Information and Collections Care and Management Competencies", "Public Programming Competencies" and general "Management Competencies" are shown as interrelated branches and leaves of the *Curricula Guidelines* "tree".

Disciplinary and grievance procedures

The principle of fair and equal treatment of all employees must always apply not just to the recruitment of museum staff, but also to all aspects of staff management. For this reason it is important that there is a fair and understandable procedure that will be followed should there be any complaint about the behaviour or performance of any member of staff. Also, any member of staff who has a grievance or complaint about any work related matter that affects them should similarly have the right to put forward their complaint and to have this investigated fairly and without undue delay.

As there can be important legal implications and consequences if someone is, for example, dismissed improperly or without good cause, the museum's codes or rules for investigating and responding to both disciplinary complaints and staff grievances will need to

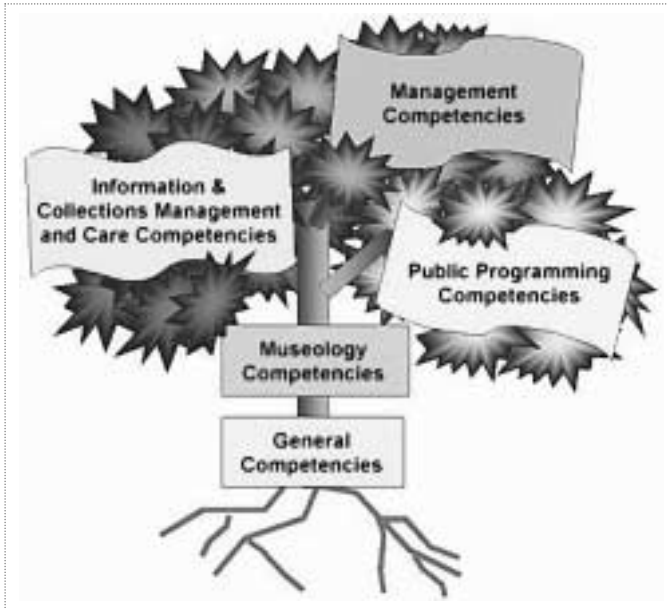

Box 10: ICOM Curricula Guidelines for Museum Professional Development:
(full details at <http://museumstudies.si.edu/ICOM-ICTOP/index.htm>)

relate closely to all national labour laws (and perhaps government service rules). However, these are likely to include some universal principles of good personnel management as summarised in Box 11 (Disciplinary Procedures) and Box 12 (Dealing with Staff Grievances).

Health and Safety at Work

One of the most important management responsibilities is to ensure that so far as reasonably possible, the museum and its activities provide a safe and healthy working environment for all who use the premises and services, both staff, whether paid or unpaid, and all visitors and other users. Typically, health and safety responsibilities are coordinated as part of the institution's personnel function and where there is a specialist Health

BOX 11:

GENERAL PRINCIPLES FOR DISCIPLINARY PROCEDURES

These:

1. Should be in writing
2. Should specify to whom they apply
3. Should provide for matters to be dealt with quickly
4. Should indicate the disciplinary actions which may be taken
5. Should specify the levels of management which have authority to take the various levels and forms of disciplinary action
6. Must ensure that immediate superiors do not have the power to dismiss without reference to senior management
7. Must provide for individuals to be informed of the complaints against them
8. Must provide for individuals to be given an opportunity to state their case and answer allegations before decisions are reached
9. Should give individuals the right to be accompanied by a trade union representative or fellow employee of their choice
10. Should ensure that, except for "gross misconduct" as defined in the Disciplinary Code for the organisation, no employees are dismissed for a first breach of discipline
11. Must ensure that disciplinary action is not taken until the case has been carefully investigated
12. Must ensure that individuals are given an explanation for any penalty imposed
13. Should provide a right of appeal and specify the procedure to be followed

Underlying principles that need to be applied throughout:

14. *Fairness in application of disciplinary rules:* management must be consistent, even-handed and unbiased (e.g. have other employees, perhaps of a different grade, been guilty of a similar disciplinary offence, and if so have they been treated differently?)
15. *Representation:* in the case of serious matters being investigated by a formal disciplinary hearing, the employee accused must be allowed assistance and representation.

Clear and consistent procedures, based on principles of natural justice, and allowing:

16. Prior notification of the nature of the disciplinary offences alleged
17. Sufficient notice of the formal hearing (usually not less than seven clear days)
18. Separation of the roles of complainant (e.g. supervisor) and the members of the disciplinary panel. (In the case of very small organisations it may be necessary to bring in "outside" independent persons as members of a disciplinary or appeals panel because most of management have been too closely involved in earlier stages of the case)
19. Adequate opportunity during the hearing for the employee to hear full details of all allegations and to reply to these (including the right to call material witnesses)
20. Promptness in all stages of investigating and pursuing disciplinary action

and Safety Manager, this post is likely to be located within the Personnel or Human Resources Management section of the museum. If the museum does not have a specially trained full-time Health and Safety Manager, then an effective alternative needs to be made. This will probably mean that these duties will have to be undertaken by an appropriate existing member of staff at a fairly senior level, who will probably need specialised training in the duties of the post.

However the health and safety function is organised, there will always be the need for close cooperation with all other parts of the service, and particularly with the Premises and Security Department, since many potential hazards relate to the construction and operation of the buildings, and with the specialist laboratory staff, such as that of the Conservation Department, because of the necessary use of special and potentially hazardous chemical substances and equipment.

Beyond this, however, health and safety must be regarded as the responsibility of absolutely everyone. The Director and other senior managers carry the ultimate responsibility, and in a growing number of countries the top management of any workplace face the possibility of personal criminal liability in the event of any serious safety or health failure. Similarly, the heads of all departments and specialist sections, and supervisory staff in e.g. conservation laboratories, each have responsibility for ensuring that hazards are kept to a minimum within their areas of responsibility. In addition the museum needs to have a very active programme of both general health and safety training, and special instruction and training in the proper and safe use of particular processes or equipment.

However, every employee has also a responsibility to contribute to maintaining safe and healthy working conditions for both other members of staff, visitors, and not least for themselves, and to comply with all necessary safety

BOX 12:

GENERAL PRINCIPLES FOR GRIEVANCE PROCEDURES

Definitions: Successive levels of grievances

Dissatisfaction: . Anything that disturbs an employee, whether or not expressed in words

Complaint: Spoken or written expression of dissatisfaction brought to attention of supervisor and/or staff representative

Grievance: A complaint that has been formally presented to a management representative and/or staff representative

Grievance Procedure principles

1. All employees have a right to seek redress for grievances relating to their employment
2. Each employee must be told how to do so
3. Management should establish, with employee representatives or trade unions concerned, arrangements under which individual employees can raise grievances and have them settled fairly and promptly
4. Except in very small establishments where there is close personal contact between employer and employees, there should be a formal written grievance procedure
5. Individual grievances and collective disputes are often dealt with through the same procedure. Where there are separate procedures they should be linked so that issues with wider application can be passed from one to the other, (e.g. individual grievance can become trade dispute)
6. A Grievance Procedure policy should provide that:
 - a) the grievance should normally be discussed first between employee and the immediate superior
 - b) if not satisfied at this stage there should be personal hearing by more senior management representative (e.g. Departmental Head), and the employee should have the right to be accompanied by an employee representative or other worker if he or she so wishes
 - c) there should be a final right of appeal to higher level (e.g. senior management; Governing Council of the Museum)
7. The aim should be to settle the grievance:
 - a. fairly
 - b. as near as possible to point of origin
 - c. simply
 - d. rapidly

rules. The obligations of both the institution collectively and individual staff members are summarised in Box 13.

Finally, but by no means least, as part of its health and safety work programme, the museum needs to have an

BOX 13:

RESPONSIBILITY FOR HEALTH AND SAFETY IN THE MUSEUM AND ITS ACTIVITIES

The employer's duties include:

1. Making the workplace generally safe and without risks to health
2. Assessing the risks to your health and safety and recording the significant findings of this
3. Making arrangements for implementing the health and safety measures identified as being necessary by the assessment
4. Drawing up a health and safety policy statement, including details of the health and safety organisation and arrangements in force, and ensuring that all staff are aware of this, and know what they should do if they face a risk or danger
5. Nominating someone competent to assist with health and safety responsibilities
6. Setting up emergency procedures
7. Making sure that work equipment is suitable for its intended use, so far as health and safety is concerned, and that it is properly maintained and used
8. Considering in advance the health and safety consequences of introducing new equipment, materials or ways of working, and of building alterations
9. Providing adequate first-aid facilities and arranging for the regular training and retraining of designated first aid staff
10. Making sure that the workplace meets accepted health, safety and staff welfare requirements, e.g. for ventilation, temperature, lighting, and for sanitary, washing and rest facilities
11. Taking all necessary precautions against danger from fire or explosion, including the proper control and use of flammable or explosive laboratory and other chemicals, and electrical systems and equipment
12. Avoiding hazardous manual handling operations, and where they cannot be avoided, reducing the risk of injury by the provision of necessary special equipment and staff training
13. Providing free of charge to all staff any necessary protective clothing and equipment for their safety and protection, according to the nature of their work, such as hard hats, eye protection, safety footwear and lifting aids
14. Providing necessary safety and other warning signs, barriers and alarms, and ensure that these are maintained

Every employee also has responsibility for health and safety, and in particular must:

1. Take reasonable care for their own health and safety at work and that of others who may be affected by what they do or do not do
2. Cooperate with the employer and all designated staff on health and safety
3. Undertake all necessary safety training arranged by the employer, such as first aid training or special training in the safe operation of specialist equipment
4. At all times use correctly all equipment and material provided by the employer, including personal protective equipment, in accordance with training or instructions
5. Not interfere with or misuse anything provided for their health, safety or welfare.

active programme of risk assessment, involving as many staff as possible. The aim should be to identify both hazards and risks, to evaluate each, and to seek ways of eliminating these, or where this is impossible, to reduce each to an acceptable level of risk. Box 14 below summarises the national risk assessment process recommended to every employer, whether public or private, by the United Kingdom's Health and Safety Executive.

BOX 14:

HOW TO ASSESS RISKS IN THE WORKPLACE: FIVE STEPS IN RISK ASSESSMENT

HAZARD: means anything that that can cause harm (e.g. chemicals, electricity, working from ladders, etc.)

RISK: means the chance, high or low, that somebody will be harmed by the hazard

STEP 1: Look for the hazards

Walk around your workplace and look for anything that could reasonably be expected to cause harm. Concentrate on significant hazards that could result in serious harm or affect several people. Ask other employees what they think. The instructions or data sheets for equipment and materials supplied by the manufacturers of these can also help you spot hazards and put risks in their true perspective, as can the museum's records of past accidents or ill-health.

STEP 2: Decide who might be harmed and how

Don't forget the possible risk to members of the public, such as museum visitors, to specially vulnerable people such as young workers, new and expectant mothers, the disabled etc. who may be at particular risk, and to workers who may not be in the workplace all the time, such as maintenance contractors or part-time cleaners.

STEP 3: Evaluate the risks and decide whether the existing precautions are adequate or whether more should be done

Consider how likely it is that each hazard could cause harm, and whether more can be done to reduce the risk. Even after all precautions have been taken, some risk usually remains. What you have to decide for each significant hazard is whether this remaining risk is high, medium or low. Your real aim is to make all risks small by adding to your precautions as necessary. Give priority to any remaining risks which are high and/or those which could affect most people. In

taking action ask yourself (a) can I get rid of the hazard altogether? (b) if not, how can I control the risks so that harm is unlikely? In controlling risks apply the principles below, if possible in the following order:

- a. try a less risky option
- b. prevent access to the hazard (e.g. by guarding)
- c. organise work to reduce exposure to the hazard

STEP 4: Record your findings

Your real aim is to make all risks small by adding to your precautions as necessary.

If you find that something needs to be done, draw up an 'action list' and give priority to any remaining risks which are high and/or those which could affect most people.

STEP 5: Review your assessment and revise it if necessary

Sooner or later you will bring in new equipment, substances and procedures which could lead to new hazards. If there is any significant change, add to the assessment to take account of the new hazard. Don't amend your assessment for every trivial change, but if something introduces significant new hazards of its own, you will want to consider them in their own right. In any case, it is good practice to review your assessment from time to time to make sure that the precautions are still working effectively.

EXERCISE:

Using the guidance notes above, carry out a risk assessment for either your own working area within your museum, or, working with colleagues in a group, prepare a risk assessment for the whole building.

Marketing

Paal Mork

Head of Communications and Marketing, Norsk Folkemuseum, Oslo

During recent decades, museums have put a greater emphasis on attracting the visitors' attention, and marketing has therefore become an essential museum management tool for museums in a growing number of countries. Important reasons are that in many countries government financial support has been reduced, while the competition for people's leisure time is tougher. Society in general is also faced by an increasing flow of information, and getting visibility is more challenging than ever.

Museums that focus on the audience in all aspects of their operations have a greater potential to gain popularity and new visitors. Communicating with the audience is not a one-way process. The truly successful museum will not only communicate its mission to its audience, it will also receive feedback from the audience and then use this information to adapt the needs and wants of the audience in its development programmes.

I believe that museums in many parts of the world, particularly those in developing countries, have a great potential for increasing visitors numbers if more emphasis is put on a marketing orientation. In a more stabilised political situation, we can assume that more travellers with cultural interests will find their way to what have been over recent decades politically troubled regions and countries of the world, such as the Middle East and countries like Afghanistan or Iraq. "My clients are thirsty for the knowledge that Iraq has", Geoff Hann of Hinterland Travel says, while museums in Iraq or other countries that have recently suffered conflict will probably also have a potential to be meeting places for

friends and families. In the longer term they might also be venues for reconciliation between divided communities, as is now happening in post-conflict Northern Ireland. But this all requires a positive attitude towards marketing and audience services.

This chapter provides an introduction to the key topics of modern museum marketing. I will start with the marketing mix, then describe the strategic planning process and end up with a brief introduction to brand-building.

1. Introduction to marketing

A common mistake both in business life and in museums is to regard marketing solely as the process of promotion and sale. "Selling is only the tip of the marketing iceberg", the famous Professor in Marketing, Philip Kotler (2003, p. 9) says. Modern marketing is characterised as the holistic process, ranging from designing the product, segmenting the market, managing the promotion and finally researching the customer's satisfaction. A commonly used definition is that of the American Marketing Association (1985): "Marketing is the process of planning and executing the conception, pricing, promotion and distribution of ideas, goods and services to create the exchanges processes that satisfy individual and organisational objectives" (Lancaster 2002, p.3).

Production orientation

In the early days of industrialisation, manufacturers were focussed on making the best possible products. In a general shortage of goods, the customer would buy them

without requiring special products and certain design. Henry Ford said about his Model T car that, “you can have any colour you want; as long as it is black!” (Lancaster 2002, p.7). No one even thought of asking for a clear blue metallic one with cream leather interiors!

Sales orientation

During the 1950s and 1960s, markets became filled up with most industrial products and the sales rates decreased. The orientation was then shifted towards the sale of the products. The production went on as before, and to assure that the products were sold, sales strategies were developed to convince customers to buy even more goods.

Marketing orientation

With a marketing orientation the customer becomes the main focus. Instead of making products to sell, the manufacturer considers the needs and wants of the customers and makes products to satisfy them. Production is based on needs of the market. Marketing orientation not only includes a process of promoting products to the customer, but also a communication and research to find the needs of the customer. This orientation characterises most modern marketing. The development is reflected in the international travel industry. In the 1970s and 1980s, tourists were satisfied by being loaded on huge charter aircrafts and guided around in common groups or they sat on a beach with thousands of others. However, nowadays the trend is very much towards independently tailored tours and unique experiences.

Societal marketing concept

A further development is also emerging, called the societal marketing concept. This argues that production should also take care of the environment and social needs. As the French oil company Total puts it: “Civil Society expects companies, especially the biggest ones, to manage the environmental impact of their operations

and industrial risk, as well as to plan for and manage their direct and indirect social and societal impacts, wherever they are located”. (Desmarest 2003, p.2)

The current orientation of museums in relation to marketing theory and practice

Many museums are still production oriented. In such cases the choice of exhibitions is decided by the curators alone, based on their personal interests and topics of research. The facilities for visitor services have probably been neglected, since the senior curators may never visit these areas anyway and almost certainly rarely encounter the ordinary visitors to the museum. Typically, the museum programmes are built around long-term plans where only internal factors are taken into consideration.

And when, as a consequence, the management sees visitors disappearing, they hire a marketing manager to promote the old exhibitions in accordance with the sales orientation approach. But very often, the true problem is lack of attractive exhibitions and other visitor facilities. Simply intensifying the promotion and sales efforts can hardly solve that problem: you need to have a relevant and worthwhile “product” to sell first. A successful museum is one that integrates marketing fully into the strategic planning and budgeting process. All audience-oriented efforts are then done with the visitor in mind, and visitors’ wants, needs and behaviours are regularly researched and new programmes developed in accordance to them.

For example, the Norwegian Broadcasting Company was the only authorised TV channel in Norway until 1991. The company was production oriented and the producers decided what programs they wanted to make and when to broadcast them. After deregulation, the company had to adapt to a situation of competition, and started producing and transmitting programmes based on viewer ratings, changing over to the principle of

marketing orientation. As a consequence, the company remains the most popular TV channel in Norway despite all the new competition.

The marketing mix

The marketing orientation depends on a set of key variables in the process from product design to sale. These variables are called the marketing mix, and a common way of sorting them out is based on E. Jerome McCharty's "4Ps of Marketing": Product, Price, Promotion and Place (Kotler 2003, p.6). The 4Ps emphasises that everything from shaping the product to the promotion is marketing.

4Ps of marketing

Product Price Promotion Place

Product

The product is the object or services the customer wants or needs and it is the essential part of the marketing mix. If the product is not needed or wanted no other efforts will make it sell. From the point of view of the general visitor the museum's "products" in these terms are mainly the main galleries, the special exhibitions and the other parts of the museum open to the public. But for other visitors this also means the research facilities, the service areas and places to meet friends and relatives, such as a museum restaurant or cafe. All of these areas have to meet the visitor's satisfaction, because if the museum is not attractive, it will not gain and maintain popularity even if you offer free admission and spend a fortune on advertising. This was the big mistake of those who tried in the past to build marketing success from the production and sales orientation approaches to marketing. The same

mistake has been made in many museums around the world. The exhibitions were "production" based, and not made to satisfy the needs and interests of visitors: in these circumstances promotional activities could not save the museum. Through surveys and interviews with focus groups, the audience can make an impact in the early phase of the exhibition planning and development, and the resulting exhibitions will then be much more related to the audience's preferences.

Price

In the product industry, price is an important tool to win competition and gain profit. For museums, price is a widely used tool to encourage certain target groups. The entrance fee should not be the same for every visitor. If the museum wants to make profit in the travel industry, it can be smart to offer the tour operators reduced prices. Sponsors and donors are happy to receive free tickets for employees and important contacts. Maybe it would be an idea to cooperate with other museums to launch a common ticket valid for different museums? In Europe a strategy of free entrance to museums is gaining popularity. The idea is to encourage groups that normally do not visit museums or cannot afford a museum visit to come.

Promotion

The need for promotional activities can vary a lot. A museum showing unique treasures known to most of the world can have a steady flow of visitors with hardly any promotion, while the neighbouring museum with less attractive collections have to struggle for every visitor. The promotional activities are described in detail later in this chapter.

Place

For the product orientated industry, the placing and the distribution of the products are essential. An advertised product that is not in stock will make the customer disappointed. Most museums have a fixed location, and

“place” is rarely the same as distribution. “Place” in museum marketing terms is commonly characterised as the visitor’s transportation to the museum. If the museum is placed way out of town with poor transport connections or in an area that is not considered as safe, it could be an idea to organise transport from a downtown location for the visitors. In very different circumstances both the Getty Museum, Los Angeles, and the Zuider Zee Museum in the Netherlands provide visitor parking away from the museum, with free transport, by tramway and by boat respectively, to the museum itself. Museum bus services (or even museum ferry boats in Amsterdam) that stop at the city’s museums are common around the world. If the museum receives educational or tour bus groups, bus parking is needed. It is a good idea to offer travelling exhibitions, so that even people from smaller cities and towns or other regions can appreciate the museum collections.

2. Strategic market planning

The marketing mix needs to become part of the museum’s philosophy and long-term goals in a strategic plan. The strategic plan points out an overall management structure for all activities of the museum. It defines the mission and describes how and by which objectives the mission shall be accomplished. The plan will of course also deal with topics that are not related to marketing, like collection management and research, but I will not discuss these matters here. The strategic plan has to be continuously evaluated and adapted to changing circumstances. An audience-oriented museum will direct the targets in the strategic plan towards the preferences of the public, and the plan will be market-oriented. As a supplement to the strategic plan, the museum can develop a separate marketing plan and plans for other activities.

Mission and Vision

“Mission” describes the purpose of the organisation. The

Marketing-related issues of the strategic plan

Mission and vision	The purpose and ideas of the organisation
Situation analysis	Internal and external factors analysed in relation to strengths, weaknesses, opportunities and threats
Objectives	The organisation’s main targets for the coming period
Market segmentation	The division of recipients in target groups
Promotion	The efforts of informing the market
Control	A final analysis of all objectives in relation to their achievement

main objectives of museums, to collect, conserve, study and communicate, are often listed on equal level and without any strong priorities. A general and describing mission, formulated in the early days of the museum, will not encourage the museum to further development. If the museum wants to specialise in a certain field, or move towards a marketing orientation, a reformulation of the mission can be required. Through a reformulation process, the management can see and understand more clearly what the objectives and future challenges of the museum are.

“Vision” reflects the primary priorities of the museum. It describes or summaries the ideal situation that the organisation wants to become. A vision could for example be that a museum wants to be the most comprehensive museum on national modern art, or the best facilitated place to experience national archaeological treasures.

Situation analysis

Every museum’s success is depending on a set of internal and external factors. In the strategic planning process it is essential to know the limitations and possibilities both inside the organisation and in the world around. These factors can be sorted out in a “SWOT” analysis, analysing the Strengths, Weaknesses, Opportunities and Threats facing the museum and the environment.

Internal factors

Strengths and weaknesses

External factors

Opportunities and threats

Internal factors

In the SWOT analysis all internal factors are analysed in relation to whether they represent a strength or a weakness to the organisation. Internal factors can be such as the competence of the staff, the quality of the collections, the financial situation, the museum site or the condition of the museum buildings. A museum will always have certain strengths and weaknesses. It is important not to let the weaknesses overwhelm the planning process. Some weaknesses can even be turned into strengths. The looting of the Museum in Baghdad in the 2003 conflict initially weakened even further a museum that had already been in very serious difficulties for more than a decade due to the national and international economic and political situation. However, the events of the spring of 2003 gave the museum a unique international promotional position: the situation can be turned into a strength, since the whole world heard about the museum and its severe problems.

External factors

Using the SWOT analysis techniques, external factors are analysed in relation to which Opportunities and Threats they represent for the museum. External factors are of course the visitors, but also possible cooperation partners, and not to forget the competitors: other museums, heritage sites, different leisure activities including sports facilities, as well as – increasingly – leisure-orientated retail shopping facilities. The political situation, governmental regulations and also the macro environment, like political upheavals, demographic shifts and economic cycles are all external factors. All

these factors should be analysed and divided in groups that represent opportunities for the museum on the one hand and threats on the other. Examples of current threats for museums serving international visitors in the Middle East are political unstable situations and regulations of the tourist market due to religious regulations. If tour operators could overcome these limitations and offer tours to the region, this would represent great opportunities for these museums.

Objectives

The objectives are the specified targets set for the museum during a certain period. They are one of the most important and also one of the most practical parts of the museum's strategic plan. Concrete targets are easy to understand, follow and measure. There are numerous examples of museums that have failed in setting up their key objectives. The result can likely be that the curators are planning an exhibition in a hall scheduled for total renovation while the marketing department is running a different campaign.

While the mission describes the overall aims of the organisation, the objectives describe how to accomplish the mission. And while the vision describes the ideal situation the organisation is stretching out for, the objectives break it down to realistic and time limited efforts. Objectives should be SMART – Specific, Measurable, Achievable, Realistic and Time-related (Lancaster 2002, p. 239). The strategic plan must contain realistic objectives for the whole organisation. And when the plan is evaluated after a given period, the attainment of each objective is measured. A museum where the vision is to become the best place to experience and understand national archaeological treasures, could have the following key objectives in a five-year period:

Five year plan for launching new offerings

Year 1	Market research and Planning Process
Year 2	Create funds for the new development
Year 3	Build a centre to encompass the new facilities
Year 4	Develop the new facilities
Year 5	Launch the new offerings

Market segmentation

No museum can be everything to everyone. Some offerings will suit some people better than others. In the strategic plan, the audiences should be broken down to specified target groups. This is called market segmentation and provides an understanding of whom the offerings are made to suit. Market segmentation is introduced here and will be discussed further below.

Promotional activities

If the strategic plan is followed up with a marketing plan, the promotional activities might only be briefly introduced in the strategic plan. The promotional activities are discussed in detail below.

Evaluation

After a defined period, the strategic plan is evaluated. The objectives must be analysed to see if they are achieved or not. Maybe external or internal factors have changed, and the course has to be adjusted. The strategic plan should include a set of success criteria, and after a certain period their fulfilment is analysed. To ease the evaluation, the objects of the strategic plan have to be measurable. “The visitors’ services will be improved”, is rarely a good objective, since it is difficult to control if the visitors’ services are sufficiently improved. Quantitative data like visitors numbers and economical status are easy to control. Qualitative data can be more of a problem. A good idea is to break the objectives

down to controllable tasks, such as: “The visitors’ service will be improved by introducing a new information system”. The audiences’ judgements must also be researched. It is of little use to see visitors’ numbers rise or fall if you do not know why. Opinions can be measured by surveys where visitors are interviewed or are asked to fill in a questionnaire. Surveys should also include non-visitors to find out why they are reluctant to visit the museum. (See also the Visitor Services chapter)

3. Target groups

Forgetting about the often very diverse population of the city, region or country served (with its wide range of ages, education and ethnicity) is a common problem in planning the exhibitions and other public programmes of museums. As has already been suggested, exhibition topics often seem to be based on the fields where the curators have their expertise and special interests, and not on what is most attractive for the audiences. The curators who claim they will make an exhibition for “everyone” are probably only aiming it at themselves and their closest colleagues.

All offerings have to be made with certain target groups in mind. A text for well-educated adults will not be readable for children. A European tourist will probably not understand texts which are only in Arabic. And while tour groups may only spend 20 minutes in a museum, individual visitors may spend hours. It is important to bear in mind that target groups are not only the visitors who come through the museum door. It is just as much the government or regional authorities that fund the museum, potential sponsors, donors and cooperating partners.

Market segmentation

Segmentation of markets can be done in several ways. The museum should develop the segmentation that is

best suited to distinguish between the different variables of the potential audiences. Some common ways of segmentation are described below (Kotler 1998:125).

Market segmentation

Geographical segmentation	Segmentation in accordance to the visitors place of origin.
Demographic segmentation	Segmentation in accordance to the visitors age, sex, education etc.
Psychographic segmentation	Segmentation in accordance to the visitors social class, lifestyle, personality etc.
Organisational segmentation	Segmentation in accordance to organisations connection to the museum.

Geographical segmentation

Some museums mainly cater for local visitors, others receive many international travellers. A museum focussing on local visitors should put the emphasis in a changing programme, to achieve repeat visitation. A museum that attracts travellers can permanently exhibit some must-see attractions, since most guests are first-time and perhaps even once-in-a-lifetime visitors.

Demographic segmentation

People of different ages have different priorities at the museum. By diversifying the audiences in variables like age, sex, family constellation, occupation education and social class, target groups can be sorted out on a demographic basis.

Organisational segmentation

As mentioned above, the cooperating partners of the museum are also target groups and should be segmented on an organisational level. They can be segmented in types of organisations, like governmental organisations, authorities, research partners, sponsors, donors etc. But they can also be sorted in accordance to their support of the museum.

Target audiences

Some target groups can be especially worth considering for museums that want to develop their marketing approach. Below I have suggested a range of such groups together with ideas for approaching them.

Families

Many museums around the world are putting greater emphasis on the family market. Parents are happy to educate and entertain their children through a museum visit, and they can all enjoy common experiences. Museums are also well suited areas to meet other family members and relatives for a day off. But it is a market of strong competition. Families can meet in parks, where they do not have to pay entry to the museum, or they can go to more entertainment-oriented offers. To reach for the family market, museums must be made to suit the family needs.

First of all, the museum has to be open on the national or religious rest days, when families have leisure time, for example Fridays in Muslim countries, Saturdays and Sundays in most other countries of the world, as well as during the local school holidays. It is also an idea to arrange family programmes like storytelling or guided tours for children on these days and during school holidays. However, more extensive adaptations should be made to suit family groups: looking at the exhibited objects is only one of the reasons for families to visit the museum. Just as much, they are there to meet others and share experiences, so good informal meeting facilities are needed to attract this market. A good café is also a very frequent request, though family groups also look for areas where they can just sit down, relax and have a chat. Special rooms or spaces where children can engage in creative play or make copies of the museum objects have been a great success in many museums.

To reach the family market, advertisements of the special family programmes would probably be the best channel.

But I would believe that most museums cannot pay for extensive newspaper advertisements. If the museum offers guided tours to schoolchildren, the calendar of family events can be distributed to the children, and maybe the local newspaper will cover family events, encouraging families to come for the next show. Another possibility is to build a good relationship to important members of certain families and mail out information to them.

The travel industry

The Arab countries and the Middle East have many remains of very early stages of the western civilisation. Such a broad choice of unique cultural treasures offers an excellent opportunity to gain profit from tourism. Egypt has taken the full advantage of this market for more than a century, and the tourism industry is today a considerable source of income. Other countries of the region have for various reasons not put the same efforts in this market. This will also influence the museums. If the government gives tourism more attention, it is easier for museums to gain more visitors from this segment. With a stable political situation and acceptance from religious forces to open up more areas to foreigners, museums will probably have a great potential to attract more tourists. The travel industry is a stable source of income to many museums, and hopefully this can be the future situation in more countries.

Tour groups have special requirements. Most tour organisers want their groups to visit the most famous treasures in the shortest possible time, other organisers want to go in depth and the groups spend much time on certain topics. The Norsk Folkemuseum in Norway distinguishes the offers for tour groups in accordance to the time available for the visit. If the group has 20 minutes available, the tourists can see the main attraction, a 12th century wooden church. With 45 minutes, the tourists can join a more comprehensive

guided tour, and with 90 minutes they can even enjoy storytelling, folk dancing and a snack.

To be successful in the travel market, it is vital to provide the tour operators with sufficient information about the museum. Geoff Hann has many years of experience with organising tours to the Middle East. I asked him about museums in Iraq, and he said that the problem is that nobody knows where they are. One good idea might be that all museums in the same country cooperate to produce a handbook for the travel industry. This could contain a description of the museum, main sights, opening hours and service facilities. Distributed to tour operators that are eager to initiate tours to the region, this would benefit all parties. But the museum can start initiatives today if you wish to start by sending information to travel guide publishers and to tour operators that arrange tours to the region. This information can contain general information about the museum, press releases and personal letters to inform about tourist related offerings.

Pilgrims

Pilgrims are a special kind of tour group and number some tens of millions a year worldwide, but is a potential market which tends to be neglected by museums. Also, while most categories of tourists quickly vanish when security and safety are threatened, the flow of pilgrims is probably more stable. Even at the height of the armed conflict in Bosnia-Herzegovina in the 1990s, more than a hundred thousand pilgrims a year continued to travel right through the middle of the war zone to visit the recently established shrine to the Virgin Mary at Medjugorje, Herzegovina. Museums in locations receiving significant numbers of pilgrims should treat these as potential museum visitors, and special offers could be made in cooperation with tour operators making arrangements for pilgrims.

Schools and colleges

School classes are frequently seen in museums all over the world, and a museum visit is often regarded as part of the education. For the museum, it is vital to have a professional approach to the school system. Educational programmes should be developed in accordance to the school plans, and classes should be invited regularly. It is no doubt that a person that has a positive childhood experience from the museum is more likely to visit the museum as an adult. Also, through the school children, information about the museum's events can be distributed to their families. It is quite common for children who visit a museum or a particular exhibition as a school visit to return a few days later bringing their family and friends. (See the Museum Education chapter)

Sponsors

Sponsors are private companies that offer the museum funds or services and expect something of equivalent value in return, in contrast with philanthropists who support the museum as an act of good will. The museum's obligations to the sponsor can be anything from a connection to national values to a reception in the exhibition hall.

In recent years, we have seen a flourishing private industry establishing in markets that earlier has been neglected due to various conflicts. An example is the growing corporate industry of former Soviet republics. A way for global companies to receive local recognition is to offer sponsorships to local organisations.

According to the societal marketing orientation as mentioned above, international companies that establish in new markets will probably be interested in securing social, environmental and even cultural values. A market of potential cultural sponsorships will occur. Museums should continuously analyse these opportunities and follow up all establishments of companies that traditionally have supported cultural activities.

The best way to approach a market of potential sponsors is to make personal contacts. The museum should thoroughly analyse the profile of potential sponsors, and provide them with distinctive and attractive offers of sponsorship and the benefits available in return, based on their individual needs.

4. Promotion

Promotion is the distribution of information about the museum's offerings to the audiences. It is important to bear in mind that this is a communication process that requires action both by sender and receiver. While the museum is sending a message through a chosen channel, the receiver must actively accept to receive it and act upon it.

Model of communication process

(Lancaster 2002:69)



The traditional communications mix consists of advertising, public relations, direct marketing and different ways of sales. I would like to add the Internet as a certain form of communication.

Advertising

Advertising is a paid published message in the commercial media – newspapers, magazines, radio and television – controlled by whoever pays for it. The advertisement has

to create interest by a broad audience to justify the paid amount. There are different types of advertising. Image-building advertising promotes often only the name and trademark of a company. Product advertising is promoting an exhibition or another general offer at the museum. Classified advertising attracts the audience to a certain event. I would believe that most museums (unless they have a good sponsor) are most acquainted to product and classified advertisements. These advertisements encourage the audiences to immediate action.

The Advertising Objectives

(Kotler 1998:222)

The Target:	Who must we reach?
The position:	What are the offering's merits and its point of difference from competitive offerings?
Response desired:	What audience response is being sought?
Time horizon:	By what period should objectives be achieved?

To convince the recipient, the advertisement needs what marketing experts call a "Unique Selling Proposition" (Kotler 2003, p.310): an offer that is attractive enough to draw the recipient's attention. According to marketing theory, only one message can be transferred effectively at one time, so it must be so strong that the recipient remembers the product or service advertised and prefers it to other competitive offerings. Therefore, if an event is advertised, it is better to promote one main happening, rather than try listing all the museum's activities.

According to the DAGMAR marketing model (Defining Advertising Goals for Measured Advertising Results) (Lancaster 2002, p.74) the recipient is passing through the following steps before the aim of the advertisement is accomplished:

- From unawareness to awareness
- To comprehension
- To conviction
- To action

These steps also require different kinds of advertising. At the first stage the audience is unaware of the museum. Image-building advertising or other ways of promotion is necessary to give the audiences knowledge about the museum. At the level of comprehension the museum is known, and product advertising is used to promote certain advantages to stimulate the audience's preferences for the museum. At the level of conviction, the recipient has a positive attitude towards the museum; he only needs a reason for the visit, like a certain event, an exhibition or a family programme. If all levels are successfully fulfilled, the recipient might go to action, the desired result of the advertisement.

Public relations

Modern public relations is a sophisticated process where the aim is to build up knowledge and attitudes. It is defined as the deliberate, planned and sustained effort to establish and maintain mutual understanding between an organisation and its public (Lancaster 2002, p.82). The use of public relation in the communications mix requires a free and independent press. If the press is dominated by a certain view or meanings are controlled, the general theories of public relation might not suggest suitable methods.

The impact of professional public relations on the corporate industry has increased through the recent years. Today most companies have communications managers on top management level that handle all press-related issues. These managers have an image of being honest, informative and available 24 hours a day. Their mission is to develop a positive personality of the company, so that even crisis can be handled in the most positive way.

For museums, public relations is a channel of growing importance. While advertising is ideal for promoting a certain event, public relations is excellent for image-building. A great advantage of public relations is the high credibility. While most people are sceptical to what is said in an advertisement, they believe in what is written in the newspaper. And it is cost effective, as the museum only pays distribution costs. While many museums cannot afford to advertise, they can still receive newspaper coverage. But the competition for coverage is hard, and the editorial boards have become more reluctant to what they accept as a good story.

Addressing the press

A public relation effort in its simplest way starts with sending a message to the press. Unless it is really big news, it will probably get no attention at all. Professional public relations efforts are needed. The list below can give some useful ideas to help the message come through.

Public relation efforts should be part of well-planned campaigns. A newspaper article can call on people's attention or provide background information, but opening hours and special offers are better filled in through advertising, posters or direct marketing. Public relations efforts should be selective. Big stories require big campaigns. Small stories should not be paid the same attention.

Press releases can be distributed broadly to inform the press, but a good relation to certain journalists is better built up by providing them with exclusive information. Press releases should be short (maximum one page), well formulated and the important issues mentioned first. All releases must include a date and contact details for the PR manager.

Be available. Be prepared to provide any information at any time, and send out information regularly. Plan the send-outs to suit the deadline of the most important

media. The beginning of the week is the best time to suggest new stories.

Suggest different angles to different media. Newspapers, TV and radio are different in form and need distinctive presentations of the information. The museum needs to have talkative experts ready for interviews and provide well-formulated background material. Remember that not all experts perform well on TV and that lots of information can soon be too much for a journalist with a tight deadline.

Do not give up easily, but realise when enough is enough. A letter, fax or e-mail might not result in action. If the story is good, always follow up by phone calls. If you are turned down, try to suggest another angle. But do not start arguing. That will cause trouble next time you make contact.

Direct marketing

Direct marketing are the promotion efforts that are directed towards a specified group or even specified individuals. While advertisements and public relations hit broad and uncontrolled, direct marketing is controlled and directed toward specific targets.

Direct marketing typically involves sending letters out to museum friends, other contacts, visitors and potential donors, and generally depends heavily on a database for storing and categorising information about target groups. To encourage important and influential people to spread knowledge about the museum is also a sort of direct marketing.

Mail-outs are probably the most common sort of direct marketing. According to a survey among performing arts presenters, direct mail was considered the most effectual way of promotion (Kotler 1998, p.248). A museum can customise this channel, so that different groups receive different offers. School children are invited to the school programmes, while repeat visitors receive the calendar of events.

Organised direct mail operations can be initiated with the mail-out of invitations to new exhibitions. Build up a comprehensive database of important persons in companies, politics, the local government and the authorities. Even if they do not come to the opening show, they observe that the museum is active. Then information about shows and events can be distributed to selected categories. Finally certain individual bodies can be invited to support the museum.

Personal contacts can be a vital promotional channel for museums. In a country where the access to a free press makes advertising and public relations difficult, it can be of great importance to stay in contact with certain “ambassadors” that encourage people to visit and support the museum. Such important persons can be politicians, top managers of companies, local authorities and family leaders. Build up a good relationship by inviting them to special events, offer special service at the museum and keep them updated with mail-outs of information.

The database for direct marketing is not a simple list of names and addresses. It should be categorised based on certain criteria, like type of organisation, visitor preferences, contributions to the museum, geography and so on. The database is easily stored and made accessible through a computer programme.

The Internet

The Internet, and particularly the World Wide Web and e-mail, is a unique channel for communicating with the audience. Enormous amounts of easy accessible information can be distributed at a minimal cost. The Internet is international and largely independent of local and national regulations, particularly if a museum’s website is on a foreign server. Even a very simple website can be interactive, with the audience and the museum having a two-way communication. A website is easy to construct and publish: a high-school student and a

global company use basically the same methods for publishing. Internet services have developed very quickly since they were opened up for free use by general users in 1993, and will probably play a much more comprehensive role in the future.

To receive international recognition for a museum’s website, it is a good idea to join the international top level domain for museums, “dot museum” (.museum). The domain is supported by ICOM, and on-line registration is at <http://www.musedoma.museum>.

However, the Internet also has its limitations. While advertisements and direct marketing reaches out to the public, such as all readers of a newspaper or all watching a television programme, the public has to actively look for the information on a website. However, subject to any legal restrictions such as privacy rights, e-mail can be a very effective medium for circulating information to interested people who agree to the inclusion of their e-mail address on a museum mailing list.

It is said that the ideal selling situation is the seller on a market who cries out his offerings to the huge crowd visiting the market. Compared with the Internet, this seller cries out his offerings in a virtual office. But the office building is several hundred stories high, and each floor has thousands of offices. The chance that someone pops in at the office to hear the offerings is fairly limited. To make sure that visitors find the way to the website, over the past few years all kinds of search directories have been offering to list a museum’s website as a paid service. The problem is to distinguish the good services from those who are only in it for the easy cash, and in fact the latest developments in Web search engine technology make such services less necessary.

All together it is becoming vital to be visible on the Internet, even if this is nothing more than a simple page with basic visitor information plus an e-mail address. For

tourists, particularly those from abroad, a check on the Internet is often the first step in holiday planning. If the museum is visible on the Web, it is more likely to receive attention. Though Internet provision is extremely variable across the developing world, access and affordability are increasing all the time. Even if it is not possible to provide an Internet service immediately, it is important to have a strategy for the museum's website development, and to get the museum on the Web as soon as possible.

5. Building a Museum "Brand"

Quite simply explained, a brand is just the name of a product. But the brand is also something more than a label, a name or a special package. The brand creates a worldwide recognition of a certain product. A brand associates the product with certain values in addition to the product itself. A Mercedes is not just a car, it has a profile of luxury, and you anticipate you can drive it through snowstorms or through the desert and arrive safely on the other side. Most people associate a set of common meanings with large global brands. These meanings will also be connected to the people that use the brands. If you drive a Mercedes, people assume you are rich and well situated. Brand equity is the term used for the brand meanings, and they can be of enormous value for the manufacturer. They form an important part of the profile of the manufacturer and their range of products. But the manufacturer can never fully control the values of the brand. The consumers will inevitably create their own meanings. Coca-Cola is in a way identified as an American icon, and whatever the USA does is likely to have an influence on the image of the company, whether they like it or not. Brand-building has been an essential business strategy in the corporate world for a long time. In the recent years it has also become an

important issue in the cultural sector and non-profit organisations.

Controlling the brand equity

Building a strong brand for a museum can be seen as a process of four steps. The process start with the least desired position, where the audience hardly know about the museum. On top is the most desired position, where the museum has a huge group of loyal contributors, who not only use the museum themselves, but recommend it to others. The following description is based on David Lane Keller's model of Customer-Based Brand Equity (2003. p.75). It is a tool for building strong brands based on the customer's point of view.

The museum brand building process

- 1 **Identification** The audiences identify the museum, the name and the type of museum.
- 2 **Meaning** Exhibition and visitors profiles and general attitudes will form the audience's meaning about the museum.
- 3 **Response** Visitors will make judgements, and develop certain feelings about the museum.
- 4 **Relationship** Some visitors recommend the museum to others, work as volunteers and maybe let the museum become a part of their lifestyle.

This process has to be followed step by step, and the museum can only rise to a higher level when the steps underneath are achieved. You can not expect the audience to have an opinion about the museum without knowing of its existence, and you can not expect the audience to become loyal visitors without having positive feelings about the museum.

Identification

First the audience must know about the museum, the name and what kind of museum it is. Every day you can

see the labels of internationally known brands in different situations. In international sport events, certain logos are posted all over the sport arena and even on the players. This is to assure that people keep the name of the company in mind at all times. I do not mean that your museum should buy the sponsor rights of an international sport event. But to strengthen the identification of the museum, you should make sure that the audience has the museum in mind as often as possible, and in as many different situations as possible.

When they want to visit a museum, your museum is the one they think of. When they want to study or meet friends and relatives, your museum is a nice place to do it. To achieve this situation, the identification of the museum has to be carefully built up. If it is a new museum, a name and a logo that identifies the museum must be created. If it is an existing museum, the main objectives can be promoted in a slogan. Many museums have had their name and logo for a long time, like the British Museum. To change it can be a risk. A well identified brand is a great advantage in the brand-building process. Many large companies have failed in an attempt to launch a new brand. If the museum already has a well-known brand name, it might be better to put new content to it than to change it. This can be achieved by adding a good slogan. The Boston Museum of Science added the slogan "It's alive" to illustrate their new profile (Kotler 1998, p.261)

Meaning

Secondly, the audience must know certain features connected to the museum, such as exhibition and research profiles, visitors services, pricing policies etc. At this level the visitors will even make their own meanings about the museum, based on experiences and user profiles.

The basis for these features will be the exhibition profiles and the research topics. A museum of modern

art can focus on experimental and maybe provocative modern art and attract visitors that prefer such challenges. Or it can focus on broadly accepted and well-known artists, to attract huge audiences. Other features include the level of service. A family-focussed museum must have facilities for children. A research-focussed museum needs facilities where researchers can study the collections of the museum. The museum will also be measured on its reliability and stability. The museum must be open when it promises to be, and the objects must be exhibited in an accessible and attractive way. All members of the staff are ambassadors for the meanings, and must reflect the desired level of service.

All these features are tools to create meanings of the museum. But the visitors will also create their own meanings, a general attitude of the museum. In general marketing, these meanings are based on who the users of a product are, in which situation the product is used and the personality and history of the manufacturer. These meanings are formed by the identification and features mentioned above, but also of the general opinion and personal experiences.

Such meanings are clearly seen in the modern car industry. Volvo has had safety as their main profile and their loyal customers appreciated it. But in peoples minds, the safe, somewhat heavy and maybe slow car was by no means regarded as exciting. Volvo is now changing its attitude towards a more sporty orientation. The car is still profiled as safe, but it is also loaded with horsepower and a great sound system. Probably this is a way to reform people's opinions and to attract more excitement- and leisure-oriented families.

The user profile is also essential for the brand-building of museums. If the museum has a profile of high-level research, school children might not dare to contact the museum. And if the general opinion is that the museum

only shows dull old exhibitions, it will probably not be chosen for a Friday tour with the family. Museums that are personalised with exciting offers and good service are more likely to receive attention.

Response

If you manage to create a general meaning of the museum, you can expect the audience to judge the museum and create certain feelings about it. While the brand meanings are more connected to the general features and comprehension of a product or service, the brand response is more related to the manufacturer's specific level of quality, uniqueness and the customers' considerations and their personal feelings.

To reach the third level of the brand-building model, the museum must express a trustworthy level of quality. The exhibitions and publications of research results must be scientifically correct, and all staff must be well skilled. It is essential that the audience trust the statements of the museum. The museum will then be treated with respect and receive strong recognition. But it is not enough to offer high quality. The museum must also have an active approach towards the audience, so that they consider using the museum. On the contrary, the museum might end up in a passive situation, where it is highly recognised, but sparsely visited.

To achieve the desired situation, the museum needs some kind of superiority – something that is unique and attractive. It can be some unique treasures, exhibitions based on excellent research, or simply the best café in town. The visitors will also develop certain feelings about the museum. Feelings and experiences are highly used in modern marketing. As the quality and design of products are less differentiated, the feelings that arise by using a certain brand have become essential. Cultural treasures can create very strong feelings. Just imagine the tourist who has travelled through insecure areas to experience the walls

of Babylon or the pilgrim who finally encounters the mosques of Kerbala. If the museum manages to implement strong feelings about some key objects, they can serve as icons for the museum.

Relationship

The highest and most desired level of brand-building is to have a group of loyal visitors that visit the museum regularly, recommend the museum to others and support the museum both economically and by voluntary work. They might even let the museum become a part of their lifestyle. In modern corporate marketing, more emphasis is directed towards this group. It is considered as five times more demanding to gain a new customer than to keep an existing one. Many museums have already operated for years in this segment with their friends associations. The museum friends pay an annual amount to show their loyalty and they might support the museum with extra funding and voluntary work. If the museum has this kind of loyal visitors, you should take good care of them and encourage them. They are your most valuable visitors. They know the brand and what it stands for.

Museum Security and Disaster Preparedness

Pavel Jirasek

Department for Protection of the Heritage, Czech Ministry of Culture

“So little for this picture? Come on, it’s a museum piece!”



Photo: Jiří Černý

Security is everybody’s business

One of my long-time friends, a museum worker and museologist par excellence, used to begin his lectures on

collection building with a memorable sentence: “Without collections there would be no museums. But remember: it’s not the same the other way around!” Many people everywhere across the planet feel a need to collect various objects. To satisfy it, they need not set up a museum. On the other hand, museums are obliged to build collections; with them it is more than just a sign of interest in cultural objects of one type or another. Of course, museum-based collection-building is not an end in itself. If a museum collection is to be used effectively and communicate the information it contains to visitors, it must not only be continually developed, but, above all, preserved for future generations. Of course, museum-based collection-building is not an end in itself, and this does not mean that a museum collection should be kept intact under all circumstances and that no object should ever be permanently removed from it.

However, this should happen only as a result of a clear collection-building strategy of the museum, not because of external influences that may substantially damage or even completely destroy the collections, regardless of the museum’s strategic decisions. Such a disaster destroys the museum itself. To prevent it, museums use special security systems.

Note: the loss of some objects whose value in financial terms is not too significant compared to the value of the collection may nevertheless be an immense loss of scientific or cultural value of the collection as a whole.

All museum staff (not only guards, but also curatorial and technical staff and management) form part of its

security system and the same applies to every operation taking place in the institution and all resources used by it. Nobody, not even any of the visitors, can be allowed to opt out of the security procedures. A museum is simply a special institution entrusted with the custody of immensely important objects for the present time, and which are at particular risk from theft, vandalism, fire, water, chemicals etc. Everyone who is in any way connected with it must respect this fact and cooperate with the security procedures. The security system also includes external relations of the museum with its principal partners (e.g. fire brigade and police).

In addition to the collections, the museum must, of course, also ensure the protection of its visitors and employees, of its other property and its reputation.

A museum can be a high risk location, and the risks are high in all these categories. The collections in particular are threatened by vandalism, fire, water, chemicals etc.

Moreover, individual objects from the collections may be traded with great profit, since the demand for articles of this kind is constantly rising. Museums accumulate such objects in great quantities and in a comparatively small space. This, of course, substantially increases the risk of theft. It is especially important to note that security systems in every area of activity are at greatest risk from the inside, i.e. by a lack of discipline, non-observance of basic rules, indifference and, sadly, through staff assisting criminals either directly or by providing information. Museums cannot exclude this risk: indeed there have been proven cases of theft, burglary and even armed robbery where staff involvement has been proved or at least strongly suspected. Consequently a few changes in the way people behave may be more effective than sophisticated and costly electronic systems.

If the basic rules of security are observed, the risks are minimised. However, any system is subject to the well-

known rule that a chain is no stronger than its weakest link. The collapse of the weakest part of a system may cause the collapse of the whole. Unfortunately, the weakest link is usually discovered only after something unpleasant has happened. This chapter will focus on the prevention of such incidents, it will tell you how to build an adequate museum security system, how to tackle certain kinds of risks and how to act in emergency situations.

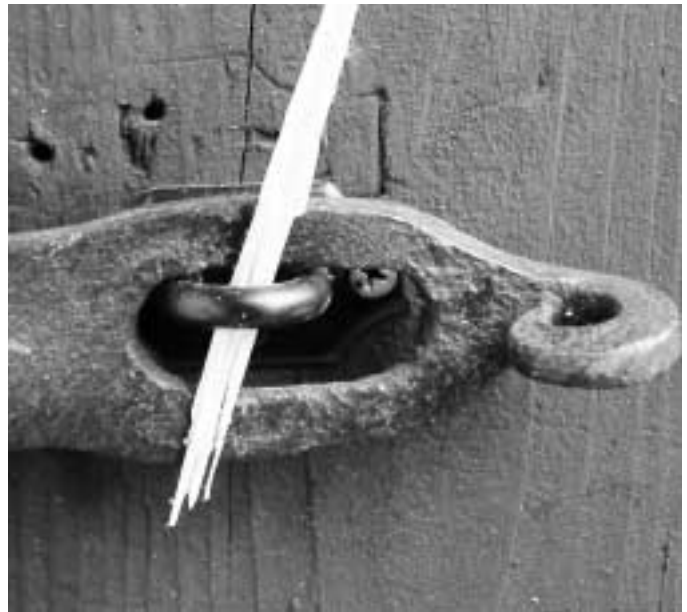

Photo: Pavel Korda

Defining a security policy and building a security system

The security of a museum can be ensured only through a clearly defined security policy and its proper application. However, the effectiveness of a security system depends on the acceptance of a number of

Some basic definitions of terms used in this chapter

1. Museum security is the immediate capacity of a museum to fulfil one of its basic tasks, i.e. protect its employees, visitors, collections, other movable and immovable property and reputation.
2. Risk analysis is a process in which the museum management identifies the frequency and seriousness of dangers threatening the museum (its employees, visitors, collections, other movable and immovable property and reputation). The outcome of risk analysis is the assessment of each of the risks – for the purposes of this chapter, on a five-grade scale:
 - a. negligible
 - b. low
 - c. medium
 - d. high
 - e. catastrophic
3. Acceptable risk is a risk whose frequency and extent cannot cause a major loss to the organisation (e.g. damage of an object that forms part of a collection, health damage etc.). The level of acceptability, i.e. the extent of acceptable loss, is defined by the organisation itself on the basis of moral criteria and the laws and regulations of the country.
4. Security policy defines, on the basis of risk analysis, the required level of the museum's security (the acceptable level of individual risks).
5. Security management of a museum includes all management instruments, measures and procedures having impact on the level of the institution's security.
6. Strategic plan of museum protection includes all planned activities aimed at fortifying the organisation against various kinds of risks (ensuring security of the museum) on the required level and with clearly defined priorities.
7. Emergency plan contains a written summary of measures and procedures used in accident and emergency management, i.e. a summary of planning, methodological and information documents used for decision making, management and co-ordination in such situations. The emergency plan must exist in a written form; it should be drawn up by the director of the organisation. In the case of a museum of a public authority the plan must be in accordance with the emergency plans of the country, region or municipality, which are usually drawn up by an authorised department of the Ministry of the Interior or of the regional government, where such plans exist. Other museums, such as those of foundations, societies or universities, should aim to follow similar national or local standards and procedures in consultation with the emergency services.
8. Museum security system includes all technical means and organisational measures aimed at ensuring the required level of security.
9. Operational card of the prevention and protection plan is the documentary material containing basic information on the museum premises, necessary for the intervention of special forces neutralising the consequences of an accident or emergency.

measures and on the approach of all museum staff to their implementation.

The security of the collections and of the museum itself is a variable depending on a number of external and internal factors. As I mentioned in the previous section, the risks characterise the seriousness of danger threatening the museum. The implementation of a security policy through the strategic plan of museum protection should minimise the risks.

Who is responsible for security policy and its enforcement?

1. The director of the museum should define its security policy, which must be based on risk analysis.
2. A staff member designated as security manager should be authorised by the museum director. The responsibilities should include analysing the risks for all buildings and premises owned and managed by the museum, or leased by it for exhibition or storage of cultural goods. The risk analysis might also be carried out by an expert company with well-established supplier reputation, perhaps a specialist consultancy in the field or possibly the museum's insurance company. A simple risk analysis may be carried out with the help of the form provided in Annex 2 of these guidelines at the end of this chapter.
3. All staff, and particularly all managers and supervisors in every department, must be responsible for implementing and enforcing the security policy.

Risk Analysis and the Security Plan

The director of the organisation or the security manager determines the acceptable risk for all identified dangers and all buildings and premises (the five point scale given under (2) in Box 1 may be of use here). In practice this means that for some buildings (e.g. a store housing building material which is a safe distance from the main museum) a medium risk of fire may be acceptable, while for others even a low fire risk must be excluded (particularly exhibition rooms and collections storage areas). The comparison of this planned risk level with the

actual results of risk analysis then determines the priorities in the elimination of individual risks and provides a basis for the strategic plan of museum protection.

In implementing the strategic plan for the museum, the director or security manager adjusts or develops the security system of the museum as appropriate.

Thus the basic principles for building an effective museum security system depend on a continuous risk analysis, its evaluation and the incorporation of its conclusions in the form of concrete measures into the everyday operation of the museum. As already pointed out, it almost goes without saying that this should be part of the duties not only of the security personnel, but of all museum staff.

Though it will normally be the security personnel who take appropriate steps to tackle the actual or expected security problem in accordance with the management's orders, everyone must know what to do and who to inform in the case of an actual or suspected security or safety emergency. This means that training in security procedures and response to actual or threatened security failures or other emergencies must be part of the museum's programme of training and continuing professional development of every staff member, regardless of their status or job.

Today, risk analysis is a separate discipline, focused on by specialised companies or expert teams of government institutions. Sophisticated modern analysis systems include as its integral part the modelling of system behaviour for purposes of emergency management, which enables us to monitor the behaviour of individual subsystems as well as of the security system as a whole. Also, one must take into account not only emergencies which will occur with a high level of probability, but also those with a minimum probability level, but potentially

catastrophic consequences. Everything is thus based on the identified level of risk. It is very significant that the insurance industry is now one of the major funders and sponsors of longer-term environmental risk research and publication, such as that of the Benfield Natural Hazards Risk Assessment Centre in London University.

The catastrophic impact of, for example, a tornado or earthquake occurring in the given area perhaps once in every ten or fifty years must not, of course, be neglected in developing the museum security arrangements. However, there are dangers whose destructive effect on objects in museum collections is not immediate, but which are still very significant. Such influences include e.g. aggressive atmospheric pollution or light, whose long-time negative effect may be comparable with that of a dramatic natural event lasting just a few-minutes (see the Conservation chapter).

For each of the dangers the level of acceptable risk must be determined, i.e. the museum must decide how serious a risk of the occurrence of a particular situation it is willing to accept. Of course, some dangers occur quite independently of the museum's will and behaviour. However, it is possible to adopt preventive measures for each of the situations and thus to limit substantially their potential consequences. By preventive measures I mean the building of the museum security arrangements, or, more precisely, the individual sub-systems of the security system, whereby the strategic plan of museum protection may be implemented.

Implementing the strategic plan for museum protection

On the basis of risk analysis the museum management may start building the security systems and procedures – provided that it knows what should be protected against what, what can or, on the other hand, cannot wait and what

The most significant potential dangers that need to be assessed. Risk analysis must take into account all dangers that may significantly damage the collections or the museum itself

1. Risk from natural disasters

- floods - both from rivers and the sea (coastal erosion, tsuamis and storm surges)
- drought or a limited supply of water
- strong wind storms and tempests
- lightening and excess voltage caused by atmospheric forces
- extensive forest fires
- extensive infestation by pests and vermin (insects, rodents, fungi...)
- earthquakes
- volcanic eruptions

2. Technical breakdowns

- damage to the structure of the museum building
- fire in the building
- loss of key utility services: electricity, gas, phone and security connections
- water supply failure
- breakdown of heating or cooling systems
- failure of fuel supply
- breakdown of air conditioning systems
- breakdown of monitoring systems
- stoppage of waste disposal
- stoppage of transport services needed for essential supplies and for key staff to get to work
- chemical contamination
- leakage of fuel or chemicals

3. Accidents

- any damage of the collections
- loss of critical data such as collections documentation, whether manual or computer-based
- damage to the building, interior furnishings and equipment
- injury to or death of a staff member or a visitor
- cumulative effect of any of the above

4. Illegal activities

- unauthorised entry of persons
- burglary
- theft including thefts committed by staff members
- robbery or other unauthorised presence of an armed person
- arson
- attack on the building during civil riots
- explosion or a threat of explosion
- assault, including sexually motivated crimes
- breach of the peace or other objectionable behaviour
- wilful damage of museum property, including vandalism and graffiti
- alcohol or drug abuse on the museum premises
- extortion of money by blackmail
- terrorist attack

5. Armed conflict risks

- bombing and shelling damage
- destruction of electrical and electronic systems, including security and building control systems and computers and computer data by electronic warfare attacks
- military occupation or other illegal misuse, whether by the attacking or defending forces
- requisition of the building, equipment and vital supplies by the government or an occupying force for war purposes or as part of aid to the civilian population
- looting, whether by military forces, irregulars or the civilian population
- loss of key museum personnel due to call up or volunteering for military service, or to death or injury
- inability of staff to get to work because of the security situation or restrictions on movement imposed by the military
- attack by irregular forces or insurgents
- greatly increased risk of general crime, including theft, burglary and robbery due to general disorder

This list is not exhaustive, but it illustrates the diversity of potential dangers.

level of protection is needed in individual cases. In short:

Implementation of the plan = satisfactory security management of the museum.

Establishing or updating satisfactory museum security management is likely to include the adoption and implementation of concrete improvement measures and

solutions, more specifically the following:

- organisational changes in the museum;
- installation of new technical equipment;
- implementation of appropriate procedures and precise definition of tasks for each museum department and possibly also for each employee of a department.

However, it is always necessary to make sure that individual measures are mutually consistent – that one does not impede or cancel the effect of another.

There are many general solutions for museums, many of which do not differ significantly from one another. However, one must always take into account the specific features of individual museums, e.g. the location of the buildings, interior layout, the nature of the collections etc. To ensure effective protection of people and property, one must proceed from simple (and not too costly) measures to more complex ones, gradually approaching the optimal security conditions defined by the security policy (what is to be protected against what and how much).

What follows is an example of how the museum security system may be built like a chain of subsystems with mutual logical and functional links, beginning with the simpler ones and ending with the most complex:

1. Mechanical barriers

These include in particular solid walls of the building, doors, locks, fire door, bars, fences, alarm glass, showcases, safes, safe rooms etc. All this makes up the basic level of protection of the collections against destruction; all other systems are only complementary.

Solid doors, adequate locks and their proper use are the most important elements of museum security.

2. System of organisation of guards (also known by various other names, including warders, attendants and museum assistants in different countries and museums)

The management should set down rules of conduct for these. The number of guards or attendants depends on the



Photo: Dana Einhornová

number, size and character of the buildings and exhibition rooms, the number of visitors and on the value of the collections. Security closed circuit television systems and

electronic alarms are a suitable complement to a guard or an attendant, but cannot replace their services.

3. Organisational measures concerning the behaviour of the staff and visitors

These measures must be continually updated, as exhibitions change, visitors are offered various services etc. In many countries there is the power to make special laws or regulations under the criminal code concerning the behaviour of visitors within public museums, and perhaps non-governmental museums also.

4. Measures to ensure security in display and exhibition rooms

These are measures reducing the risk of accidents and injuries of both staff and exhibition visitors (arrangement of objects, types of showcases etc.).

5. Intruder Detection System (IDS)

This is a higher protection level, which is, however, effective only in combination with mechanical barriers and other subsystems of protection, typically for out-of-hours protection or for protecting areas not open to the public. This will be discussed later along with automatic fire detection and alarms in a separate section.

6. Access Control System (ACS)

This exists in one form or another in every museum, and is important for internal control of staff behaviour. In its simplest form it is the giving out of keys against signature or other written record. Contemporary sophisticated systems are usually based on electronic readers. After reading the information provided by the entering person (magnetic, IR or other cards or an electronic device on the key chain), the equipment sends the signal to a central computer, which checks the right of entry. If the system is electronic-based including monitoring from a central control room, it substantially reduces the risk of theft by the museum's own employees. It either works independently of other systems, or is interconnected with



Installation of motion detectors in historical interiors

Photo: Pavel Korda

intruder detection system and automatic fire alarm. The access control system may also be complemented by a metal detector at the museum entrance.

7. Closed Circuit Television (CCTV)

As a suitable complement to the intruder detection and fire alarm subsystems, this protects the collections as well as visitors and staff. It is used in particular for alarm confirmation and in furnishing evidence of illegal activities. At present institutions are gradually moving away from large monitoring desks with a number of monitors to a new type of system, which switches the monitor on only in case of an alarm incident. Such incident is then reported to the control room staff (which also receives the image of the "alarm monitor") and digitally recorded in a quality mode on a data storage medium. The existence of the central control room is the necessary precondition for full exploitation of CCTV possibilities. The cameras should be located at least in those parts of the interior where all visitors have to pass. The CCTV subsystem is needed to

eliminate false alarms of peripheral subsystems of the intruder detection system. It is also important because of its preventive, psychological effect.



Outside camera in a special case, ambient temperature -20°C
Photo: author

8. Internal communication and reporting of emergencies

This subsystem protects in particular attendants in exhibition rooms. It is based on the use of emergency call equipment – mobile, with radio data transmission, or stationary. Another option is the use of walkie-talkies. Contemporary subsystems can distinguish between non-standard situations, not immediately threatening the life or health of the attendant on one hand, and immediate assault on the other. They also enable a comparatively precise localisation of the place from which the signal has been sent.

9. Measurement and regulation of critical physical quantities (temperature, humidity, intensity of light and UV radiation)

This subsystem is used in museums mainly to monitor the environment in which collections are kept. It is also

an outstanding tool for studying the long-term effect of physical influences.

10. Measurement of technical quantities (water, gas, dust fall)

This subsystem helps identify an oncoming incident with potential catastrophic consequences.

11. Internal and external lighting

This is important for prevention and useful when monitoring buildings located in remote places.

12. Protection against excess voltage caused by atmospheric forces

It is important for all light-current electronic systems. It ensures protection of systems and computers against surge on the mains input and the protection of individual system elements etc. The protection against damage has a substantial economic effect. A quality protection against excess voltage consists of three elements – avalanche diodes, varistor and surge arrester. Experience from recent years confirms the major importance of this subsystem. Many cases have been reported in which costly protective subsystems (worth many thousands of dollars) have been completely destroyed during a thunderstorm, while the installation of protection against excess voltage would have cost merely 5-10% of the price of the destroyed equipment.

13. Internal monitoring centre (Control Room)

The importance of this is self-evident: in a number of cases it is the basic precondition for the proper operation of other subsystems. However, to be able to play this role it requires 24-hour staffing and its own operational rules, it must not be accessible to people who do not work in it and must have adequate security protection.

14. Transmission of alarm data from the monitoring centre to the relevant intervention forces

The transmission of information on the occurrence of an emergency forms the basis of the security system. The



Photo: Pavel Korda

(mostly data) transmission of information to intervention forces (police, fire brigade...) should take place independently of the staff in the internal monitoring centre (control room); in case there is no such centre in the museum, the information should be transmitted directly from the detection system centre. It is advisable to use several independent types of transmission. If the only transmission channel used is e.g. a phone line, there is a risk as it is not very difficult to put it out of order. The more advanced contemporary equipment uses parallel transmission via a phone line and wireless transmission on several secret frequencies.

15. Textual and visual documentation of cultural objects, their registration and entry in the inventory

The textual and visual documentation of collections is important not only because it enhances their capacity to provide us with meaningful information on nature and society; it becomes virtually priceless in case of a police inquiry seeking to recover a stolen object, as well as in case

of restoration, the making of replicas etc. It is advisable to use e.g. the OBJECT ID international standard for information exchange.

If the object in question has been stolen, it is also important to state whether the value of the object justifies the launch of a nationwide or international inquiry, and subsequently check whether such inquiry has indeed been launched. Otherwise the police effort might be limited by the boundaries of the relevant city or region. The textual and especially visual documentation is a key factor in any inquiry. At present, museums are beginning to use various sophisticated designation techniques, such as micro-dots, DNA registration etc. for purposes of future identification.

16. Emergency plan including evacuation plan for both people (staff and visitors) and collections

A well-thought-out emergency plan is a must for any museum security system. (This is discussed elsewhere in this chapter.)

17. Co-operation with intervention forces (otherwise known as emergency services)

The persons taking part in rescue operations in case of an emergency can have different interests, The priority of the museum is to save the collections and critical data while the firemen want first of all to localise the fire, the priority of the police in case of a crime is to find and arrest the perpetrator etc.). It is advisable to discuss the plan and the rules to be followed in case of an intervention in advance, to make sure that the individual actors do not hinder one another's efforts.

18. Co-operation with relevant national and international organisations and agencies

Today there are already many international agencies monitoring the trade in cultural objects and co-operation with them brings positive results. Still, when an important object is missing from a collection it is always necessary to contact the local or national police first, according to local

arrangements and the agreed procedures. To help with the success of the inquiry, the police should get not only textual documentation, but also a photograph of the object in question. It is also advisable to check whether the police ensured the launch of an international inquiry, either through the national office of Interpol and through the Secretariat General of ICOM.

19. Priorities for conservation and restoration

In a discussion about other security subsystems, conservation priorities may seem an issue that has little to do with the rest of the problems debated. Still, conservation, preparation and restoration are crucial for the protection of any collection. They are, however, costly activities for which no museum ever has as much money as would be ideal. This is why every museum should have a plan of priorities.

An Intruder detection system (IDS)

This, together with mechanical barriers and the system of guards and museum attendants, guarantees a higher qualitative degree of protection. In designing the intruder detection system, one must always keep in mind that the time needed by the criminal to reach by the shortest possible way the object of his interest must be longer than or at least equal to the time needed (from the moment of detection) for signal transmission, alarm confirmation and subsequent intervention.

In practice this means that after detection of the intruder's entry on the guarded premises, the intruder must be confronted with one or more mechanical barriers, which it will take him long enough to overcome. This simple rule is the cornerstone of any IDS system. If it is not observed, even the most expensive electronic system is reduced to the role of a scarecrow.

However, this is frequently not the case. Since collections are often kept in historical buildings, these

usually have an outside fence or railing (if anything at all). Combined with an internal electronic security system protecting the interior and shell of the building, i.e. with space detectors, glass break detectors or window and door opening detectors, the outer railing – and therefore also the intruder detection system – does not make any sense. The critical time begins to run only after the criminals get over the railing, which is not a serious problem, taking into account their present-day sophisticated technical equipment. What would make sense would be interior bars, which the criminals would have to break through after their intrusion has been detected.

If the installation of bars is not possible, there are other possibilities, e.g. outside detectors (underground pressure detectors, outside infrared barriers that close the building from the outside). This, of course, is a costlier option, which requires links with outside cameras to eliminate alarms caused by other factors than criminal intrusion. Another complication is the fact that this modern and effective technique requires outside fences or railings, which make the immediate surroundings of the building inaccessible when the premises are protected. With many buildings, especially in built-up urban areas, such a solution is therefore out of the question.

It always pays to have the intruder detection system designed and installed by a company with a high level of expertise and to choose a tried and tested top-quality technology. This will not only ensure effective operation of the equipment, but also exclude two otherwise common problems – false alarms and nuisance alarms (caused by mistakes of the attendant staff).

The protection of the premises against burglars is complemented by the protection of the objects themselves. Here, too, the usual solution involves a combination of a mechanical barrier (glass showcase, alarm glass or alarm foil showcase) and an intruder



Photo: Czech Police

detection system. The present-day producers of showcases usually equip them with glass break or opening detectors or enable an easy installation of such equipment. What is important is the choice of detection sensors with regard to

the construction of the showcases, the type of lighting used and the nature of the exhibits. A rather difficult problem is the protection of objects in public libraries. The most effective solution is the designation of books with microchips, which activate the alarm on passing through the monitored zone.

IDS components should be selected with utmost care. Each of the components has specifically defined conditions of use. Especially when selecting sensors for use in non-heated or even open space, one should always check the temperature range for which the equipment is designed, as well as other characteristics. It is advisable to use sensors based on different principles of detection.

Automatic fire detection and alarm system (FAS)

These usually form the top of the imaginary pyramid of protective devices. It is because in case of fire the property losses are final, nothing can be recovered, but also because any fire poses a major threat to human health or even lives.

It is good to have the automatic fire detection system installed together with the intruder detection system because the cable routes may run along the same directions, saving money. Ideally the FAS can be combined with an automatic extinguisher system. However, this may pose a problem in historical buildings, since the extinguisher system interferes with the appearance of the interior much more radically than the detection system. In a compromise solution the components of the extinguisher system might be installed only in a few selected critical places of the building.

Which extinguishing substance to use is also a key decision; traditional media such as water seem to work the best. One can also recommend the water-mist fire extinguisher with an extensive range of cover, low water consumption and a comparatively low damage of interiors and collections during use.



Testing a unique water cannon (water-mist fire extinguisher)
Photo: author

The same rules as for IDS also apply to the installation of FAS, i.e. the better the technology and the greater the expertise of the company, the fewer false alarms you can expect. FAS are installed in all types of institutions

(museums, libraries, monuments): they may have software links with other subsystems, but must always operate independently.

Consideration of the nature of the material is especially important in libraries. In museum exhibition rooms one should pay attention to the combination of the sensor with the lighting of the exhibits. If the light is not duly screened off and the warmth it produces approaches in its intensity the heat range of fire, it may give rise to false fire alarms. A direct link to a fire guard control desk enhances the effectiveness of the automatic fire detection system. Each of the independently operating subsystems reduces the potential negative impact of security risks, but the most effective is the combination of several subsystems.

The Emergency Plan

One final element of a successful and effective security system in the Emergency Plan, which brings together all the key elements and the supporting information that might be needed should a serious emergency occur, despite all the risk assessment, planning and staff training.

Final recommendations and further help

I tried to fill this comparatively limited space with as much information as possible, offering at least a sound introduction to the vital importance, and at the same time complexity, of the task of ensuring the security of a museum or a collection. The Appendices that follow offer a model Emergency Plan, which can be adapted to the particular circumstances of almost every museum, and which may help you in achieving this difficult but vital task.

Finally, let me once more repeat the words that are crucial for any effective museum security system: "Security is everybody's business." If this message is true for your museum, you are halfway there. If you are interested, the

International Committee on Museum Security of ICOM can help you with your security problems and provide you with the necessary professional contacts in the field.

Appendix 1: A Model Emergency Plan

Part A

This part of the emergency plan should serve not only the museum, but should also be made available on request to the contractual or public service intervention forces that would be called in to deal with an emergency in the museum (police, fire brigade etc.)

Core

(1) The core part of the museum emergency plan drawn up by the director or security manager should include:

- a) name of the organisation;
- b) name of its statutory representative or the person responsible for emergency management (e.g. security manager);
- c) address of the organisation, phone and fax, e-mail, contact to a 24-hour security service (if the museum has one);
- d) definition of the museum's responsibility and powers in emergency management, based on legal regulations (e.g. the right to supervise the whole process of evacuation of the collections etc.).

(2) In part A of the emergency plan of the museum the author must also include the following:

- a) a list of buildings in which the objects of the museum collections are located, including phone and fax numbers, e-mail or also a mobile phone contact of the person responsible for the management of the building;
- b) the manner of protection of the buildings and objects against dangers ensuing from emergency situations;

- c) name of every member of the emergency team, phone number and e-mail address (if available) at which they may be reached (the phone calls and e-mails may be directed to the 24-hour security monitoring service of the organisation, which will then ensure further contact);
 - d) a list of persons responsible for the protection of individual buildings and collections, phone number and e-mail address (if available) at which they may be reached (as above);
 - e) description of the operation of individual museum buildings.
- (3) The author of the emergency plan must update the information contained in paragraph 4 and pass it on to the contractual or official intervention forces.

Annexes

(4) Annex 1 of the emergency plan, the only annex of its part A, contains the operational card of the museum. The operational card of the emergency plan must include:

- a) name and address of the museum;
- b) number of permanent staff;
- c) name of the contact person responsible for security of the museum premises (including phone number), a list of persons responsible for the protection of individual buildings, collections or sub-collections deposited on the premises, including phone numbers (both mobile and home) and e-mail addresses, if available (the phone calls and e-mails may be directed to the 24-hour attendant service of the organisation, which will then ensure further contact);
- d) information on critical spots (location of pressure gas bottles, stored chemicals etc.);
- e) location of main gas, water and electricity shutoffs with relevant instructions;
- f) location of the main control panel of the intruder

- detection system, fire alarm, and possibly other elements of the museum security system;
- g) nature of the deposited material with regard to its handling (volume, transportation requirements), priorities for evacuation etc.
 - h) description of suitable access to the premises, including information on the quality and bearing capacity of the communication routes and individual floors of the buildings;
 - i) lay-out of the premises with designated escape routes (on the reverse side).

Part B

This part of the emergency plan is designed only for internal purposes.

(1) The director of the museum or an authorised staff member appoints an emergency management team. The list of team members including contacts makes up an integral part of the emergency plan.

(2) The director of the museum or an authorised staff member also draws up a simple and clear list of instructions for the museum staff in case they are confronted with any of the following situations (instructions are given separately for each of the incidents):

1. Risk from natural disasters

- Floods - both from rivers and the sea (coastal erosion, tsunamis and storm surges)
- drought or a limited supply of water
- strong wind storms and tempests
- lightning and excess voltage caused by atmospheric forces
- extensive forest fires
- extensive infestation by pests and vermin (insects, rodents, fungi...)
- earthquakes
- volcanic eruptions

2. Technical breakdowns

- damage to the structure of the museum building
- fire in the building
- loss of key utility services: electricity, gas, phone and security connections
- water supply failure
- breakdown of heating or cooling systems
- failure of fuel supply
- breakdown of air conditioning systems
- breakdown of monitoring systems
- stoppage of waste disposal
- stoppage of transport services needed for essential supplies and for key staff to get to work
- chemical contamination
- leakage of fuel or chemicals

3. Accidents

- any damage of the collections
- loss of critical data such as collections documentation, whether manual or computer-based
- damage to the building, interior furnishings and equipment
- injury to or death of a staff member or a visitor
- cumulative effect of any of the above

4. Illegal activities

- unauthorised entry of persons
- burglary
- theft including thefts committed by staff members
- robbery or other unauthorised presence of an armed person
- arson
- attack on the building during civil riots
- explosion or a threat of explosion
- assault, including sexually motivated crimes
- breach of the peace or other objectionable behaviour

- wilful damage of museum property, including vandalism and graffiti
- alcohol or drug abuse on the museum premises
- extortion of money by blackmail
- terrorist attack

5. *Armed conflict risks*

- bombing and shelling damage
- destruction of electrical and electronic systems, including security and building control systems and computers and computer data by electronic warfare attacks
- military occupation or other illegal misuse, whether by the attacking or defending forces
- requisition of the building, equipment and vital supplies by the government or an occupying force for war purposes or as part of aid to the civilian population
- looting, whether by military forces, irregulars or the civilian population
- loss of key museum personnel due to call up or volunteering for military service, or to death or injury
- inability of staff to get to work because of the security situation or restrictions on movement imposed by the military
- attack by irregular forces or insurgents
- greatly increased risk of general crime, including theft, burglary and robbery due to general disorder.

In case of each of these potential incidents, the instructions should ensure an adequate flow of information, i.e. they should state to whom and how the information about the incident should be immediately reported. They should also describe how to proceed in neutralising the consequences of the incident and define tasks for individual staff members (and possibly also for external intervention forces).

The list of emergency situations may, of course, be extended on the basis of risk analysis (Article 3), with regard to the location of the museum premises, taking into account all incidents likely to occur.

The instructions should be distributed to every staff member, ideally in the form of a small booklet.

Model instructions are contained in Annex 3 of the material (Drawn up on the basis of the booklet “Staff Emergency Procedures”, The Getty Center, May 2000).

The list of instructions forms an integral part of the emergency plan.

(3) The director of the museum or an authorised staff member must also draw up a written summary of information on contractual partners for the purposes of emergency management. The material will include contacts on basic co-operating units (police, fire brigade, special army forces) and a list of contractual partners (particularly restorers, conservators, transport providers and other specialists). The afore-mentioned information material makes up an integral part of the emergency plan.

(4) The director of the museum or an authorised staff member also draws up a written time schedule of emergency management, containing information on the accessibility of the units of the Integrated Rescue System, accessibility of contractual partners, deadlines for the implementation of concrete measures in cases of expected emergencies (e.g. floods) etc. The time schedule makes up an integral part of the emergency plan.

(5) The director of the museum or an authorised staff member must also draw up an evacuation plan for people, collections and other property of the institution. The evacuation must contain information on:

- how the evacuation will be announced;
- evacuation places and emergency survival facilities for visitors and staff;
- evacuation places and emergency storage facilities for

- collections and other property of the institution;
- evacuation priorities;
- how the evacuation will be organised;
- technical support of the evacuation;
- requirements for the handling of objects from the collections;
- how the evacuated objects and possibly also other property of the institution will be designated and identified;
- designated staff members bearing full personal responsibility for the evacuation;
- evacuation routes (plan).

The evacuation plan makes up an integral part of the emergency plan.

(6) The director of the institution designates an easily accessible and clearly designated storeroom of evacuation equipment. The storeroom must contain:

- first-aid sanitary material;
- detergents and disinfectants;
- vessels with distilled water;
- personal protection equipment (gloves, protective clothing, overalls, masks, respirators, protective helmets and glasses, working shoes and wellingtons etc.);
- packaging material and manipulation equipment corresponding to the nature of the evacuated collections and other property (wrapping paper, lockable evacuation boxes and transport crates, waterproof packaging materials etc.)
- basic stationery;
- emergency salvage and rescue technology, equipment, tools and other aids etc.

All the above must be available in sufficient quantities, corresponding to the character of the museum premises. An exact description of the location of evacuation material storerooms forms an integral part of the emergency plan.

(7) The director of the museum or an authorised staff

member draws up an emergency report form by means of which emergencies will be reported to the management of the institution. A model report form is provided in Annex 4 of the Handbook.

The emergency report form makes up an integral part of the emergency plan. It must be available to every staff member of the institution.

(8) The director of the museum or an authorised staff member draws up an annual plan of checks on preventive measures. In addition to obligatory inspection and checks on technical equipment, he should review at least once a year the readiness of each independent unit (or even of the whole organisation) to face emergencies by simulating a selected emergency (training exercise). At the end of each year an authorised staff member submits the results of the checks and training exercises to the museum management for discussion. The annual plan of checks on preventive measures and the results of the checks and training exercises are regularly annexed to the emergency plan.



Fire drill

Photo: Pavel Korda

(9) The director of the museum or an authorised staff member informs every staff member about the contents of the emergency plan and his or her personal tasks and responsibilities in an emergency situation. The staff member confirms the fact by his or her signature on a protocol. The protocol is kept by the organisation until his or her employment ends or is terminated.

(10) In case of need, the emergency plan must be updated to correspond to the actual state of the organisation. Information on the modifications is passed on to those staff members whose role in emergency management has changed.

(11) The emergency plan is issued, supported by an order of the museum director confirming its implementation.

**Annex 2 to the Methodological Instructions:
 Simple risk analysis form**

TYPE OF EMERGENCY	FREQUENCY OF OCCURENCE	PROBABILITY LEVEL (1 to 5 /P/)	SERIOUSNESS OF CONSEQUENCES	DEGREE OF SERIOUSNESS (1 to 5 /C/)	RISK R = P x C	DEGREE OF RISK (/1 - 5/)	RANKING against priorities
<i>Disasters within relevant distance from the building</i>							
Floods							
Windstorms and tempests							
Extensive fires							
Heavy air pollution							
Earthquakes							
Infestation by insects, rodents etc.							
Excess voltage caused by atmospheric forces							
<i>Illegal acts</i>							
Common theft by visitors or staff							
Burglary							
Vandalism							
Improper behaviour by visitors, including physical violence							
Arson							
Unregistered entry							
Presence of armed persons							
<i>Accidents and failures</i>							
Injury of a staff member or a visitor							
Accident resulting in a leakage of chemicals							
Air conditioning failure							
Power etc. failures: electricity, gas, heating oil, district heating system							
Water supply stoppage							
Security alarm systems failures							
Security communication systems failure							
<i>Other emergencies inside the building</i>							
Fire							
Flooding from the water piping or heating system							
Excess temperature							
Excess humidity							
Excess light intensity							

Number of objects in the collections that are in serious danger of being stolen (number of pieces and percentage), i.e. T1 =< T2 + T3

number of pieces	%
------------------	---

Annex 3

Fire

If a fire occurs in your area:

1. Remove visitors (and employees) from immediate danger
2. If possible, confine the fire by closing doors
3. Notify Security Control Room/Fire Brigade at [Insert telephone number] and/or nearest automatic alarm pull station. By using walkie-talkie or phone give the following information:
 - a. location of the fire
 - b. the severity of the fire
 - c. your name

Do not hang up until the Security Control Room/Fire Brigade does so first.

4. Attempt to put out a small fire with a fire extinguisher if it is safe to do so.
5. Evacuate your area if you are unable to put out the fire. Go to an Evacuation Assembly Area

Additional information:

6. Disconnect electrical equipment that is on fire if it is safe to do so. Pull the plug or isolate at the circuit breaker or fuse box.
7. Never allow the fire to come between you and the exit.
8. Assume that smoke and/or fumes are hazardous.
9. Do not break the windows unless absolutely necessary or escape, since oxygen feeds a fire. Before opening any door touch it near the top. If the door feels hot or if smoke is visible, never open the door.
10. Do not use elevators (lifts).
11. Take any important small personal possessions (e.g. keys, purse) if you evacuate, but do not attempt to save possessions at the risk of personal injury. Leave behind anything big or heavy that will slow or obstruct your escape. If you are the last to leave close the doors behind you but do not lock them.
12. If the area is smoky, stay low to the ground underneath the smoke and heat. Crawl if necessary.
13. If your clothes or those of someone else are on fire, stop, drop to the ground and roll over and over to put out the flames.
14. Do not return to the site of the emergency until instructed to do so by the Fire Brigade or Security.
15. If you are trapped in a room:
 - a. call for help in any way possible: shouting phone or cell phone.
 - b. wedge cloth material along the bottom of the door to keep out smoke.
 - c. close as many doors as possible between you and the fire.
 - d. if windows open and you must have air, open the window. Do not break the window as it will become impossible to close it again if this becomes necessary.

All fires, no matter how small or how easily extinguished, must be reported to Security who will then notify the Fire Brigade

Annex 4 – Report form

Reported by:		
Name and surname:		
Department/section:		
Employed as:		
Date and place of the emergency:		
Date (day, month, year)	When the emergency occurred (from/to)	Where it occurred
Emergency:		
Type of emergency (e.g. common larceny)		
Cause of the emergency		
Damage caused by the emergency:		
Health damage		
Damage of the collections		
Other property damage		
Damage of the building		
Reaction:		
Reported to (person):		
Reported on (date and time):		

I hereby confirm that all information provided above is complete and correct.

Date

Signature

Illicit Traffic

Lyndel Prott

Former Director of Cultural Heritage Division, UNESCO

Introduction

A very important aspect of the duty of all museum directors, curators and other professionals is to protect the heritage from theft, clandestine excavation and illegal export. Theft may occur from exhibited materials, but often also from museum store rooms, which are subject to less frequent inspection. Clandestine excavation is a concern when a museum is responsible for a culture whose remains have been discovered. Unattended or unwatched sites attract unauthorised diggers who may cause a great deal of damage to objects and to the site by digging trenches, using poles or detaching elements from standing remains. Damage to context, especially the confusion of strata, or deliberate falsification of the claimed provenance in order to cover the tracks of the thieves, may ruin the site for archaeological interpretation. Thefts from excavation team storehouses are also common. Illegal export may involve not only stolen or illegally excavated objects, but also those subject to an export ban or restrictive licence because of their importance to the national heritage. The exporter may be the owner, but there may also have been another illegal transaction involved, such as an unauthorised transfer of ownership. In any of these cases, the heritage accessible to citizens and scholars of the country of origin is diminished.

Prevention

The first important step in managing the situation is to have a security plan. This should cover physical security (adequate exhibition cases or other protection, burglar

alarms etc.), trained security guards, a complete inventory and location list for every item in the collection, a priority list for the most important items to be protected in an emergency, and contingency plans for evacuation in case of emergency. There should be training for all museum staff in the security plan, including rehearsals for managing an emergency, and all should have the appropriate contact numbers for police and other backup services. In an emergency situation looting very often occurs.

As there have been many cases of thefts by museum staff, volunteers or contractors' workers with access to collections, or where inside information has been used to assist thieves, staff should therefore be checked for any criminal record before being employed, and casual and volunteer staff may need to be excluded from the most sensitive areas of the museum including detailed catalogues and inventories.

Inventories

In any security plan it is essential to know the contents of the museum. To this end the collection should be fully inventoried. Inventories must have enough information to allow verifiable identification of an object when found, seized by public authorities as suspect or offered for sale, either locally or abroad.

While some museums have inventories which are very detailed, they may not include the most essential information for identifying an object. A registration mark may quickly be removed. Also, it may be difficult or



The Song Dynasty Head

On 27 November 1996, thieves beheaded a stone statue from a tomb of the Song Dynasty (960-1279) to the southwest of Gongyi, a city in China's central Henan Province. The head was found in San Francisco in November 1997.

The head was easily identifiable as an exceptional Grade I object by the Chinese cultural relics authorities. The Chinese offered proofs with photographs of the intact statue originally taken to classify the tomb as a monument. The photograph of the statue, especially its historically damaged features, uniquely identified the missing head. It was returned to China in 1998.

impossible to physically mark some items, such as coins, medals, jewels, gemstones or cylinder seals. In any event, it is essential that each object has, at a minimum, 8 key items of identification and a photograph (or drawing or other image). These necessary elements have been agreed on by international museum, police, customs, insurance and data base experts and included in "Object-ID".

OBJECT ID CHECKLIST



Take Photographs

Photographs are of vital importance in identifying and recovering stolen objects. In addition to overall views, take close-ups of inscriptions, markings, and any damage or repairs. If possible, include a scale or object of known size in the image.

Answer These Questions:

Type of Object: What kind of object is it (e.g., painting, sculpture, clock, mask)?



Materials & Techniques: What materials is the object made of (e.g., brass, wood, oil on canvas)? How was it made (e.g., carved, cast, etched)?

Measurements: What is the size and/or weight of the object? Specify which unit of measurement is being used (e.g., cm., in.) and to which dimension the measurement refers (e.g., height, width, depth).



Inscriptions & Markings: Are there any identifying markings, numbers, or inscriptions on the object (e.g., a signature, dedication, title, maker's marks, purity marks, property marks)?

Distinguishing Features: Does the object have any physical characteristics that could help to identify it (e.g., damage, repairs, or manufacturing defects)?



Title: Does the object have a title by which it is known and might be identified (e.g., *The Scream*)?

Subject: What is pictured or represented (e.g., landscape, battle, woman holding child)?

Date or Period: When was the object made (e.g., 1893, early 17th century, Late Bronze Age)?

Maker: Do you know who made the object? This may be the name of a known individual (e.g., Thomas Tompion), a company (e.g., Tiffany), or a cultural group (e.g., Hopi).

Write a Short Description: This can also include any additional information which helps to identify the object (e.g., colour and shape of the object, where it was made).

Keep It Secure: Having documented the object, keep this information in a secure place.



Object-ID also provides an easy way to create an inventory record where none exists. It can be very quickly generated by trained volunteers with index cards and a pencil. There are also computer programmes available for immediate entry of data.

Once this data has been collected, it should be protected in some very secure site. If on the site of the museum, perhaps in a safe or buried under the floor. It is also very important to have duplicate copies away from the museum, and if possible outside the country. The existence of a duplicate copy of the inventory of the Angkor Conservation Centre in Cambodia, held at the French Institute of Far Eastern Studies, Paris, was a key element in tracing items stolen from that centre which had been found outside the country. Similar international or regional cooperation arrangements can be very valuable.

All this should be done well in advance of any emergency. Natural disasters are unpredictable and usually unexpected, internal and international conflicts may progress very rapidly to a stage where the emergency services are needed for humanitarian rescues and other tasks that are likely to be given a higher priority by the

authorities. Preparations should, therefore, be already well-planned and practised if at all possible in cooperation with the emergency services, so that a museum can be defended against looters even where immediate help is not available from enforcement agencies.

National Legislation

An important part of the plan to prevent illegal movement of cultural heritage items is to have adequate national legislation and regulations. These should make clear that unauthorised excavation is criminal activity and provide serious penalties by way of fines and imprisonment. Cultural items found during a house search, in a vehicle or on the suspected person should be forfeited if he or she is found guilty. A number of countries now provide for confiscation of any equipment used in such illegal activity, which is a substantial deterrent where motor vehicles, aircraft or earthmoving equipment is used.

It is advisable to provide that all undiscovered antiquities belong to the State. This facilitates recovery from other countries as all States recognize ownership rights, but not all enforce foreign export laws. Without this provision it is difficult to prove theft in a foreign court, since the requesting State has no evidence (photos or description) of the missing object. It is essential that these ownership laws be enforced in respect of undiscovered antiquities and that citizens not be allowed to appropriate State owned antiquities, since a foreign court may then refuse to enforce the ownership law against others.

Other provisions should require dealers in cultural objects to keep registers noting the provenance and previous ownership of any object in their possession as well of the purchasers' names and addresses. They all should have a clear duty to inform the purchaser of the details entered in the Register, as well as of any export limitations applying to the object. There should be

Familiarisation:

Run an exercise including museum, customs and police officers (who will all need to be familiar with Object-ID, the now accepted international standard for the exchange of key information on missing cultural objects).

Place a museum object on a table, give each participant a form and ask them to fill it out in respect of that object. Then read them out and note how differently police and customs officers may describe the object from museum staff. Make sure museum staff see that those from other services understand the terms which museum staff use.

Note also that the language used by the museum staff has to be

- Understandable by police and customs officers in your country
- Readily translatable into other languages (for international claims)
- Understandable by people in other countries who are not expert in your country's culture, or with special cultural or artistic names or descriptions.

provision for regular inspection of dealers' registers and prosecution if they are not being properly kept or false entries are found. An appropriate penalty is the loss of a dealer's licence and confiscation of any illegally acquired cultural objects found in their possession.

There may also be special penalties for museum guards or other staff, or site curators, who assist thieves or clandestine diggers.

Tourists and Visitors

Efforts need to be made to alert visitors to the country to the fact that its heritage is protected and to their duty, as a guest, to comply with the laws of the country. Posters should be placed at border entry points, particularly in airport arrival and departure areas and customs posts at land crossings and seaports. These should explain that illicit traffic is deeply damaging to the heritage of the local people and call for their willing co-operation. A leaflet explaining the rules and inviting compliance should be issued at the time of granting a visa.

In particular, visitors should be aware of

- the major categories of objects whose export, or export without a licence, is forbidden
- the criminal and civil penalties which apply, including the possibility of confiscation without compensation
- the fact that undiscovered antiquities are the property of the State
- that any object purchased should be accompanied by details of provenance, previous ownership and proof of purchase.

Tourists and others should be encouraged to buy good quality local handicrafts and museum replicas rather than seek original objects of archaeological or ethnological importance. Where possible, the authorities should set up good shops in the museums and airport departure lounges which specialise in these items.

Training

To properly prepare a security plan and carry it out, it is essential to train museum staff, police and civil defence officers, where these exist, because co-operation between them will be necessary. Integrated training seminars can be run at a regional or sub-regional level with the assistance of UNESCO or ICOM. At the national level, participants in one of the regional or sub-regional training sessions can use the publication issued by UNESCO "Preventing the Illicit Traffic in Cultural Property. A Resource Handbook for the Implementation of the 1970 UNESCO Convention" edited by Pernilla Askerud and Etienne Clement (Paris, UNESCO Division of Cultural Heritage, 1997) which was designed to help those planning seminars at the national level.

These seminars should be held regularly to continually widen the numbers of trained people and to ensure that museum staff and police develop a close relationship to rely on in times of crisis.

Detection

It is most important that crimes against cultural heritage do not go undetected, for this encourages successful wrongdoers to continue their criminal activities. Store rooms and exhibited items should be regularly checked against the inventory or Object-ID List. As well as checks for complete loss, there should be checks for possible substitution of copies for originals. Any losses should be immediately reported and a case description made out which should include the suspected date of crime (or earliest to latest suspected date); mode of entry (e.g. concealment of museum visitor after hours, breaking and entering), mode of crime (e.g. interference with burglar alarm or other detection device; opening of safe), and other information. The police should in all cases be contacted.

The best way to devise such a reporting system would be in cooperation with the local or national police. Interpol has had particular experience with crimes concerning cultural property items and will advise them on the development of an appropriate “scene of crime” report. The Object-ID record of the item or items should be attached. Where a heritage object is misappropriated for sale in a foreign market, it is essential that action be taken immediately upon discovery, since in the case of pre-planned thefts, experience shows that clandestine transportation is likely to have been already arranged in advance so it is likely that the stolen property will leave the country within as little as 12 hours. This means that the report and Object-ID need to be circulated internationally as soon as possible. This can be done by the national police section responsible for contact with Interpol. Interpol will then immediately enter the details in their data base, which is accessible by computer to all participating police and customs services, and help with other notifications or publicity.

Customs services can also play a key role in detecting objects leaving the country. Customs officers need to be included in training sessions so that they understand what are the most important and vulnerable objects in the country likely to be exported illegally. They may pick up clues when baggage or freight is presented for checking, and they also contact customs services in other countries to alert them to the issue. Customs officers also work closely with customs authorities in other countries, directly or through the World Customs Union.

Recovery

The steps already mentioned are very important because once an object has left the country, the chances of its recovery are very small. Nonetheless, many countries, when aware that important cultural property has been

Training Exercise

1. What are the most important objects in your museum? Make a priority security and rescue list.
2. What are the types of threat most likely for your museum? (Theft? Earthquake? Civil disturbance? Invasion? Flood?)
3. What type of security does your museum have? (Secure buildings? Burglar alarms? Guards night and day? Locked exhibition cases?)
4. How can security be improved?
5. Is there an INTERPOL Liaison Office in your national Police service? Is its INTERPOL membership payment current?
6. Who is the responsible contact officer in the police force for museum security and theft of museum objects? Does everyone have his contact details?
7. Who is the responsible contact office in the national customs service? Does everyone have his contact details?

illegally removed from their territory, will seek the assistance of international and foreign national authorities to have it returned and to take legal action against the wrongdoer.

This sends a warning to any dealer or collector who handles cultural material coming from that country that he or she must check that its provenance is legal, or run the risk of claims and litigation which may result in the loss of the object without compensation and also besmirch his or her reputation.

International Conventions

There are certain international treaties which are designed to help in the tracing and recovery of cultural objects which have left the country. These are

- the 1954 Protocol to the Hague Convention for the Protection of Cultural Property in the Event of Armed Conflict 1954
- the UNESCO Convention on the Means of Prohibiting and Preventing the Illicit Import, Export



International Co-operation

International co-operation can be generated through the use of databases such as Art Loss Register or Invaluable (Trace) (both based in the United Kingdom). It has become the practice of the art trade to check the database for any major purchase to ensure that it is not already registered as stolen. The catalogues of forthcoming auctions of the big auction houses are also matched to the database and have sometimes resulted in the location of a missing cultural object. IFAR Bulletins (USA) also advertise losses and UNESCO and ICOM may also give notice of selected items or of generally critical situations (such as the massive losses in Afghanistan, Cambodia and Iraq) when many thousands of objects have been looted. The greater the publicity given, the harder it will be for a dealer or buyer to claim that he or she did not know that the objects had been illegally handled.

and Transfer of Ownership of Cultural Property 1970

- Convention on mutual administrative assistance for the prevention, investigation and repression of Customs offences 1977 (Nairobi Convention) Annex 11
- the UNIDROIT Convention on Stolen or Illegally Exported Cultural Objects 1995
- Convention on the Protection of the Underwater Cultural Heritage 2001

The text of these Conventions is available at http://portal.unesco.org/en/ev.php-URL_ID=12025&URL_DO=DO_TOPIC&URL_SECTION=-471.html

Application of the Conventions

These conventions apply only between States which are a party to them. To find out if a State is a party to the Convention and the date on which it came into force for it, consult the internet site listed below:

- 1954 Convention and Protocols

<http://erc.unesco.org/cp/convention.asp?KO=15391&language=E>

- 1970 convention

<http://erc.unesco.org/cp/convention.asp?KO=13039&language=E>

- 1977 Convention and Annex 11

<http://www.wcoomd.org/ie/En/Conventions/EG0005E1.PDF>

- 1995 Convention

<http://www.unidroit.org/english/implement/i-95.htm>

- 2001 Convention

<http://erc.unesco.org/cp/convention.asp?KO=13520&language=E>

Some States will only apply these Conventions in respect of objects illegally moved after the date on which both States became a Party to them.

Over 80 countries are party to the Hague Protocol 1954, although not the United Kingdom and the United States. Major collecting and transit countries in Europe such as France, Germany, the Netherlands and Switzerland are party, so this is a very useful instrument if an object has been lost during or as a result of civil or international conflict.

There are now 104 States Parties to the 1970 Convention, including the United States, United Kingdom, France, Japan and Switzerland. Sweden and the Netherlands has announced its intention to ratify and Germany is studying the matter. All other European countries are party, so this covers the majority of transit and collecting States.

The much newer UNIDROIT Convention has 22 States Parties, but complements the UNESCO Convention and is recommended by UNESCO. It is important because it covers certain issues which are either ambiguous or not mentioned in the earlier Convention, and among many other things ensures that foreign owners can have direct access to the legal system and procedures of the country where the object is located.

The Nairobi Customs Convention now has 50 States Parties and 32 of them are parties to Annex XI which specifically deals with cultural property. Unfortunately they do not yet include any of the major art trading and transit States.

The newest Convention of all, the 2001 Convention on the Protection of the Underwater Cultural Heritage, has special provisions which will help in the recovery of objects from underwater sites which may never have entered the land territory of the State, but were in waters under its jurisdiction and subject to its law.

Altogether these five conventions cover the illegal movement and recovery of cultural heritage items in peace, in conflict, on land and underwater. They are important weapons for countries fighting the illegal trade.

Recovery where the Conventions do not apply

If neither State, or only one State, is a Party to the Convention, the rules of the Convention cannot be applied. In such cases the first step is to negotiate between institutions or individuals e.g. between a museum and private collector or between two museums. If these negotiations fail, an approach may be made on a government-to-government basis.

Litigation

While a number of countries have been able to recover illegally traded objects from other countries by litigation,



A gilded bronze bell, originally a sacrificial utensil of the Temple of Heaven, Beijing, was looted from the site by a British Officer in 1901. The bell dates from the late Ming Dynasty and is about 500 years old. The Temple of Heaven was first built in 1420, at the same time as the construction of the Forbidden City.

A descendant of the British Officer took the bell to India and gave it to an Indian Officer as a gift during the Second World War. On 22 July 1994, the Indian Officer, by then General Josh, returned it to the Chinese General Zhang Wannian when he was invited to visit China. In May 1995, a ceremony of return was held in the Temple of Heaven. Delegates of the Chinese government, Chinese Military and the Ambassador of India attended. The bell is now kept in the Temple of Heaven.

such action may prove to be very expensive. New Zealand's action in the United Kingdom to recover Maori carved wooden panels prohibited from export, which was unsuccessful, is estimated to have cost about £200,000 in 1983, while India's costs to recover the statue of a clandestinely excavated Siva Nataraja bronze statue in 1988, also in London, though ultimately successful, cost at least £100,000, although these costs were ultimately recovered from the purchaser. This is one reason why maximising action through the Convention procedures is important.

A government also needs to consider the time of its experts and administrators who may be involved for years in preparing litigation and possibly travelling overseas to give evidence. This is increased where the legal system is a different one (the differences between a Code-based [usually "Roman Law"] and Common Law based [usually English-derived] systems are significant) and where the language of proceedings and the social context are unfamiliar. Each legal system has its own rules on substance, conduct of proceedings and evidence, so that it is always necessary to employ local legal advice to some extent in another county.

The UNESCO Inter-governmental Committee

Where bilateral inter-State negotiations fail, the UNESCO Intergovernmental Committee for the Return of Cultural Property to its Countries of Origin or its Restitution in Case of Illicit Appropriation, established in 1978, will have competence. This applies where the requesting and requested States are members of UNESCO (Singapore is currently the only State which is not). The Statutes and basic mission of this Committee can be found on its website at http://www.unesco.org/culture/laws/committee/html_eng/statutese.pdf

There is a special form for the making of requests for return and Guidelines to help in its completion. These can be obtained from the

International Standards Section
Division of Cultural Heritage
UNESCO
7 place Fontenoy
Paris 75032
(email: ins@culture.unesco.org)

Forms must be completed at least six months before the next regular meeting of the Committee and include information about the circumstances of the loss, the condition of the object and a full description and history of it. The requested State then completes the file with information on the object and its condition as well as the history of the acquisition. The request is then considered by the Committee which makes Recommendations for the settlement of the dispute. The Committee is not able to take a decision, but acts as a mediator between the parties. The Committee normally meets once every two years in the northern hemisphere, in Spring (about 6 months before the General Conference).

Conclusion

Illicit traffic is an extremely complex problem which must be tackled from many sides. Museum staff have a key role to play as guardians of the national heritage. They can educate and provide the training information to help local people and the members of customs, police and administrative services recognize the significance of heritage objects, show them how to identify them as well as enlist these people in the fight against illicit traffic. Each museum needs to have a security plan, adequate and properly secured inventories and close working arrangements with the other services which will help them prevent and detect crimes against cultural heritage

Checklist

For museum staff, government officers who deal with international conventions and liaise with police and customs officers

1. Is your country party to each of the four conventions mentioned above?
2. If not, find out why and try to deal with the problem so that it can become a Party.
3. Has your country participated in the work of the Intergovernmental Committee?
4. If not, establish why and propose that an active programme of participation and/or nomination for membership of the Committee is undertaken.
5. Are the customs officers familiar with the major types of important cultural objects of your country so that they can be seized if identified at customs exit points?
6. Has your Customs Service ever taken action to collaborate with a foreign customs service to assist with the return of cultural objects?
7. Are the appropriate customs officers familiar with the 4 conventions and do they know who to contact in the foreign customs services of the major countries likely to receive illegally traded cultural objects from your country?
8. Do the police know the appropriate contact at the Interpol Head Office in Lyon? Are they familiar with the special form for action requested in respect of cultural items?
9. Have they ever notified the loss of an important heritage item to Interpol?
10. How can collaboration between police, the customs and the museum services be improved?

and to recover the objects taken. These are continuing tasks which must be performed again and again, and regular training and information sessions should be part of every museum's annual activities.

Brief explanations of some key terms as they are used in this book *(please refer also to the Glossary to the ICOM Code of Professional Ethics)*

Acid-free: A pH (acidity test) reading of 7.0 (neutral) or higher (alkaline) in a substance is a requirement for archival housing and storage materials, as acids can weaken cellulose in paper, cloth and board. Acids also weaken proteinaceous material.

Acceptable risk: A risk whose frequency and extent cannot cause a major loss to the organisation (e.g. damage of an object that forms part of a collection, health damage etc.). The level of acceptability, i.e. the extent of acceptable loss, is defined by the organisation itself on the basis of moral criteria and the laws and regulations of the country.

Access (in the context of Collections Management, Security etc.): The process of controlling who enters or leaves a secure collections storage or study area, when they may enter and leave, and where they may go and what they may do after they are inside.

Access (in the context of Visitor Services, Marketing etc.): Giving the general visitor or specialist the opportunity to use the displays, facilities and services of the museum, its research and study collections, and to meet staff. This also includes access at the appropriate intellectual level, and which is free from social and cultural prejudice.

Account: Individual record established for each category of asset, liability, fund balance, expense, or revenue.

Account payable: Debt or obligation due to suppliers or vendors for goods purchased or services rendered.

Account receivable: Money due to the organization from services rendered, donations or dues promised, grants awarded, loans made, or employee advances (not yet accounted for) due but not yet paid.

Acquisitions: Additions to the museum's collection, whether by donation, bequest, purchase, field collecting or exchange.

Advisory board (or committee): (a) Group of leaders with specific expertise responsible for providing counsel and advice to public service organizations. (b) Group of individuals, usually well known, influential, or prominent, whose public support and endorsement supplies credibility.

Advocacy: Investment in creating long-term relationships with the museum's current and potential future public. Having a loyal group of

visitors and supporting local community can provide persuasive evidence to politicians, businesses and the press that the museum is a successful organisation and worth investing in.

Annual report: Yearly report, usually focused on financial or organizational conditions, compiled and published by the organization's leadership.

Appraisal (collections management): The authentication and valuation of an object or specimen. In certain countries the term is used for an independent assessment of a proposed gift for tax benefit purposes.

Appraisal (personnel management): The periodic review, usually annual, of an individual employee by a senior representative of the employer, which examines past performance and future responsibilities, and training and other needs.

Audit: (a) Process to examine the records, files, and accounting documents of an organization, to ensure compliance with internal revenue codes. (b) Examination of financial records in accordance with procedures designed to ascertain the validity and accuracy of the financials.

Board of directors or board of trustees: Two or more individuals serving as the governing body of an organisation.

Brand: A name, term, sign, symbol, or design, or a combination of them, intended to identify the goods and services of one seller or group of sellers and to differentiate them from those of competition (American Association of Marketing). In practical terms, a brand is the name, logo or symbol of a product or a service, including a museum.

Brand equity: Brand equity is the added value the brand gives to a product. It can be of enormous value for the manufacturer or the provider of a service. The consumers or audiences can give the brand positive or negative value.

Budgeting: A process of determining the allocation and expenditure of existing or potential financial resources of a specific period of time. The budget is developed at the conclusion of the planning process where it represents the prioritized allocation of limited financial resources to accomplish stated museum objectives.

- Budget surplus or deficit:** The difference between budget receipts and expenditure.
- Accession (also Accessioning):** The formal acceptance of an item into a collection and its recording into the holdings of the museum and generally includes a transfer of title.
- Cataloguing:** Assigning an object to an established classification system and having a record containing such things as identification, provenance, accession and catalogue numbers and location of that object in the collection storage area.
- Charitable organisation:** Term in some countries used to describe not-for-profit organisations.
- Clandestine excavation:** unlicensed or otherwise illegal digging or removal of buried antiquities or other cultural heritage.
- Collection:** An identifiable selection of objects having some significant commonality.
- Collections care:** A holistic approach to the preservation and conservation of collections that involves all aspects of the museum, from the facilities in which collections are stored and used to basic policies and practices and the education and training of staff; collections care is the responsibility of all employees.
- Collections management:** Administration and care of collections with concern for their long-term physical well-being and safety. Includes issues of conservation, access and use, inventory and record keeping as well as administration of the overall composition of the collections in relation to the museum's mission and goals.
- Collection management policy:** A comprehensive written statement that describes what, why and how a museum collects. It is a public document that articulates an individual museum's professional standards about collecting and care of collections.
- Community relations:** Initiation and maintenance of communications and interaction with the community at large and with specific constituencies.
- Computerisation:** The process of transferring manual records of any kind (particularly catalogues of collections, and financial, personnel and marketing records) to computer storage and management.
- Condition report:** An accurate, written, and photographic description of an object or document state of preservation at a moment in time and updated each time the object is involved in any activity, such as going on loan or put on exhibit. Assists in planning for conservation treatment.
- Conflict of interest:** The existence of a personal or private interest which gives rise to a clash of principle in a work situation, thus restricting, or having the appearance of restricting, the objectivity of decision making.
- Conservator-restorer:** Museum or independent personnel competent to undertake the technical examination, preservation, conservation and restoration of cultural property.
- Consultant:** Someone providing services to an organization (usually for a fee) in a capacity other than that of "employee."
- Contract:** An agreement enforceable in law.
- Context:** the micro – and macro-environment of an archaeological find and specifically the spatial relationship of objects to one another and their physical surroundings which may enable the scientific establishment of the temporal relationships, especially from soil strata.
- Contribution (donation):** Transfer of money or property without the expectation of material return.
- Cultural heritage:** UNESCO defines the cultural heritage as "the entire spirit of a people in terms of its values, actions, works, institutions, monuments and sites". Within this definition UNESCO recognises in particular:
- the tangible cultural heritage:** including archaeological and other cultural sites, monuments, groups of buildings and whole historic cities, cultural landscapes, natural sacred sites, the underwater cultural heritage, museums, the movable cultural heritage of works of art and objects and collections of art, history and science, handicrafts, the documentary, digital and cinematographic heritage,
 - the intangible cultural heritage:** including oral traditions, languages, festive events, rites and beliefs, music and song, the performing arts, traditional medicine, literature, culinary traditions, and traditional sports and games.
- Deaccession:** The permanent removal of an object or collection from the holdings and records of a museum.
- Design:** An arrangement of forms and colours, or both, intended to be wrought out for use or ornament.
- Direct marketing:** Direct marketing are the promotion efforts that are directed towards a specified group or even specified individuals. While advertisements and public relations hit broad and uncontrolled, direct marketing is controlled and directed toward specific targets.
- Dealing:** Buying and selling items for personal or institutional gain.
- Documentation:** All paper and other physical records and electronic records of information relating to an object or collection; the term is also used for the process of creating records pertaining to each object in a collection.

- Due diligence:** The requirement that every endeavour is made to establish the facts of a case before deciding a course of action, particularly in identifying the source and history of an item offered for acquisition or use before accepting it.
- Designated funds:** Funds set aside for specific purposes by action of the governing board.
- Direct cost:** Expense specifically associated with and identifiable by program, project, or activity.
- Emergency plan:** A document or other statement containing a written summary of measures and procedures used in accident and emergency management, i.e. a summary of planning, methodological and information documents used for decision making, management and co-ordination in such situations.
- Employee:** One who performs services for compensation and whose working conditions are set by the employer. Everyone who works for the museum, full-time and part-time employees.
- Employee involvement:** Process through which people exercise increased control over their work to improve the effectiveness of their organizations.
- Endowment:** Money not expended, but held for investment, with the earnings available for program activities, either generally or as restricted by the donor. The principal sum is kept intact, with only its income being expended.
- Evaluation:** Monitoring or assessing the extent to which a program or organization has met its goals and objectives.
- Exhibition designer:** Professionally trained person who creates forms and solutions to a structure or space for exhibition use. Someone who invents and prepares useful, decorative or artistic design.
- Exhibition manager:** Person in charge of the coordination of the implementation of an exhibition project.
- Exhibition plan:** Written description of construction stages of an exhibition.
- Exhibition project:** Written and drawn description of a proposed exhibition.
- Expendable funds:** Funds available to finance the museum's programs and services. That portion of fund balances not already spent on fixed assets and available for use in satisfying obligations.
- Expenditure:** Actual spending of money as distinct from the budget or funding allocated. In most government and accounting systems this is usually divided into Capital Expenditure: money spent on permanent or long-term assets, for example to buy, build, improve, or rehabilitate physical facilities or equipment, and Revenue Expenditure: all other current expenditure, such as staff pay and expenses, premises running costs and regular maintenance, taxes, transport, exhibit and collections expenditure.
- Facilities management:** Directing and overseeing the housekeeping, maintenance, and structural aspects of a museum; may also include architectural assistance, space utilization, or security.
- Fiduciary:** The relationship of a person to a museum where that person is bound to exercise rights and powers in good faith for the benefit of the museum.
- Financial planning:** A systematic process of assessing and matching an organisation's monetary needs and actual or potential monetary resources.
- Focus groups:** These are groups of 5-9 people drawn from the general public who are invited in advance to share and discuss their thoughts on issues or developments. They are increasingly used in museum visitor and market research.
- Friends of the museum:** Individuals and organisations legally separate from the museum itself, but which support the museum by giving time, and/or money to help the museum achieve its ambitions.
- Fund:** An accounting entity established to account for resources used for specific activities or objectives in accordance with special regulations, restrictions, or limitations. A Fund Group is a group of funds of similar character; for example, operating funds, endowment funds, restricted funds, and capital funds. Restricted Funds and these whose use is restricted by the donor for specific purposes, in contrast with funds that the organisation may use for any purpose it chooses in keeping with its mission.
- Grant:** (a) Financial assistance to enable implementation of a project or program based on an approved program, proposal, and budget.
(b) Gift or donation received for either a restricted or unrestricted purpose.
- Governing body:** ICOM defines the Governing Body as "The persons or organisations defined in the enabling legislation of the museum as responsible for its continuance, strategic development and funding." The term is also used for any similar Board or Council established under other legally binding procedures or agreements, not requiring legislation.
- Guidelines:** Statements or documents clarifying rules. These may be changed by the issuing authority in accordance with new developments. They do not have the force of law.
- Human resources:** All of the actual and potential staff and volunteers

- that may be available to assist the museum in achieving its mission. This term, rather than the older term “Personnel”, seeks to emphasise that the labour force is one of the most valuable (and usually one of the most costly) of all the museum’s resources, and therefore needs to be effectively managed in the same way as other key resources, such as the collections and premises.
- Illegal export:** removal from a country contrary to its law.
- Income-generating activities:** Activities intended to bring financial gain or profit for the benefit of the institution.
- Information management:** The process of managing the many different types of information collected, stored and used by the museum, including collections and conservation documentation, fieldwork and other research records.
- In perpetuity:** Literally means continuing forever. This is used in reference to the curation of objects and documents by a museum for the entire length of an object’s life.
- Insurance:** Coverage by contract whereby one party (usually an insurance company, but in some cases a government) undertakes to indemnify or guarantee another against loss as a result of a specified risk.
- Inventory:** A physically checked, itemised list of the objects in a museum’s holdings. The terms Inventory Control and Location Control are used to describe collections management and administrative audit systems under which regular checks are made on each object, or a random sample of objects, to ensure that it is still in the collection, and is in its allocated display or storage location. (see also Catalogue.)
- Job description:** A document analysing and describing the key features of each job in the museum, including its purpose, conditions of employment, key tasks and main responsibilities. These are very important in both the process of recruitment of staff, and in day-to-day management of existing staff.
- Legal title:** Legal right to ownership of property in the country concerned. In certain countries this may be a conferred right and insufficient to meet the requirements of a due diligence search.
- Loan-in:** The temporary loan of an artefact or collection from another museum, institution or individual to this museum, without a change of ownership.
- Loan-out:** The temporary loan of an artefact or collection from this museum to another museum, institution or individual, without a change of ownership.
- Lux (abbreviation: lx):** the metric (SI) unit of light intensity: 1 lux is 1 lumen per square meter. The light exposure of an individual museum object or work of art is now recorded as the intensity of illumination in lux multiplied by exposure time in hours. This longer-term exposure can be expressed Mega lux hours: one million lux hours (Mlx/h).
- Market definition:** Effort by the organization to determine and define which particular segment(s) of the market its operations, services, or products should be serving.
- Marketing:** The process of planning and executing the conception, pricing, promotion and distribution of ideas, goods and services to create the exchanges processes that satisfy individual and organisational objectives.
- Marketing mix:** This describes all the marketing tools the museum uses to achieve the marketing objectives. A common way of sorting the marketing mix is based on E. Jerome McCharty’s “4Ps of Marketing”: Product, Price, Promotion and Place. The “4Ps” emphasise that everything from shaping the product to the promotion is marketing.
- Market segmentation:** Dividing the market in e.g. geographical and/or demographical segments to sort out segments where the museum has optimal opportunities. These segments can then be chosen as target groups.
- Minimum standard:** A standard to which it is reasonable to expect all museums and museum personnel to aspire. Certain countries have their own statements of minimum standards.
- Mission statement:** A brief statement that summarises the museum’s reason for existence, typically including: who we are, what we do, for whom we do it, and why.
- Museum:** See the ICOM Code of Professional Ethics, Appendix 1.
- Museum professional:** See the ICOM Code of Professional Ethics, Appendix 1.
- Museum security:** The immediate capacity of a museum to fulfil one of its basic tasks, i.e. protect its employees, visitors, collections, other movable and immovable property and reputation.
- Museum security system:** Includes all technical means and organisational measures aimed at ensuring the required level of security.
- Natural heritage:** UNESCO defines the natural heritage as comprising natural features, consisting of physical and biological formations or groups of such formations, geological and physiographical formations which constitute the habitat of threatened species of animals and plants which are of outstanding universal value from aesthetic, scientific or conservation point of view, and natural sites or precisely delineated natural areas of outstanding universal value from the point of view of science, conservation or natural beauty.

Non-profit organisation: A legally established body, corporate or unincorporated, whose income (including any surplus or profit) is used solely for the public interest, typically for the benefit of that body and its operation. The term “not-for-profit” has the same meaning.

Organisational development: Process of analysing the formal and informal structures of the museum, determining needs and problems, and designing a systematic plan for incorporating appropriate, feasible changes into the structures to increase the overall effectiveness of service delivery by the museum or one of its programmes.

Organisational structure and infrastructure: Definition of the relationships, roles, responsibilities, and capabilities within an organisation.

Person specification: This is developed from the Job Description and identifies the qualifications, skills and experience needed in order to be able to do the job at the required standard.

Pilot project: Initial project designed and funded to serve as a model for similar projects meeting the same needs in other areas.

Planning: Devising methods through which to achieve an objective. Detailed expression of an action program to reach an identified objective, enabling a coordinated, shared effort.

Preservation (of collections): The reduction of any and all future losses to the collection.

Preventive conservation: Measures to maintain the collections in stable condition through preventive maintenance, condition surveys, environmental controls and pest management (as opposed to processes involving physical intervention, e.g. restoration).

Provenance: The full history and ownership of an item from the time of its creation or discovery through to the present day, from which authenticity and legal ownership is determined.

Policy deployment: Developing and communicating guidance needed to coordinate and execute activity throughout the museum to achieve common goals and objectives.

Public relations: Public relations is the deliberate, planned and sustained effort to establish and maintain mutual understanding between an organisation and its public.

Record keeping: Design and implementation of a system to collect management or program information.

Relative humidity (abbreviation: RH or rh): The amount of moisture vapour (gas) in the air, expressed as a percentage of the maximum possible at that temperature. This is usually expressed as a percentage of the moisture level of saturated air at a given temperature.

Risk (to the collections): Degree of danger of loss to the collections, whether total and catastrophic, or gradual and cumulative from any cause, whether natural or humanly induced, accidental or deliberate. Risk can be defined as a product of probability and consequences of the incident, i.e. Risk = Probability x Consequences

Risk analysis: A process in which the museum management identifies the frequency and seriousness of dangers threatening the museum (its employees, visitors, collections, other movable and immovable property and reputation). The outcome of risk analysis is the assessment of each of the risks – for the purposes of this chapter, on a five-grade scale: (a) negligible; (b) low; (c) medium; (d) high, and (e) catastrophic.

Security: Controlled access to premises for the public, staff and researchers to limit the opportunities for theft and destruction to collections.

Showcase (vitrine): Specially designed piece of furniture dedicated to display one or several objects.

Special events: Activities used to draw attention to the museum or to raise money, for example, exhibition receptions, open houses, and banquets.

Stakeholders: the various audience groups and others with a legal, financial or moral interest in the museum and its responsibilities and work: all those people who would directly or indirectly be affected by the action of a museum including employees, government officials, the local or national community, researchers and other museum professionals as well as the visitors.

Security management: Includes all management instruments, measures and procedures having impact on the level of the institution's security.

Security policy: A document or other statement defining, on the basis of risk analysis, the required level of the museum's security (the acceptable level of individual risks).

Strategic plan of museum protection: Includes all planned activities aimed at fortifying the organisation against various kinds of risks (ensuring security of the museum) on the required level and with clearly defined priorities

SWOT analysis: An analysis of the museum's overall situation, both of the organisation itself and the environment. Internal factors are analysed according to Strengths and Weaknesses, external factors according to Opportunities and Threats – hence “SWOT”.

Target audience: The group for which an exhibit, exhibition or display is intended.

Target market: That portion of the total market selected by the

organization as the focus of its marketing, sales, or other efforts.

Teamwork: The coordinated effort and activity between several individuals in which each does a part.

Theft: a taking of property with the intent to deprive the owner of it.

Valid title: Indisputable legal right to ownership of property, supported by full provenance of the item from discovery or production.

Visitor - actual, potential & virtual: Actual visitors are the current audience of the museum, potential visitors are others within the same community or region who the museum may wish to attract in the future, while virtual visitors are those making use of the museum's information and other resources via the Internet, usually through websites and on-line databases of the museum's collections and environmental records.

Visitor studies: Market research techniques and research which aims to collect information about visitors, their views and experiences of the museum, its displays, exhibitions and services.

Web: Popular abbreviation for the Internet-based World Wide Web information and communication system

References and further information

- Ambrose, T. & Paine, C., 1993. *Museum Basics* (London: ICOM in conjunction with Routledge).
- American Association of Museums, 1984. *Caring for Collections: Strategies for Conservation, Maintenance, and Documentation*. (Washington: AAM)
- American Association of Museums (2001). *Museum Visitor Services Manual*. (Washington: AAM).
- Anderson, G. (Editor), 2004. *Reinventing the Museum: Historical & Contemporary Perspectives on the Paradigm Shift*. (California: AltaMira Press).
- Appelbaum, B., 1991. *Guide to the Environmental Protection of Collections*. (Madison, Conn.: South View Press). (Out of print)
- Ashby, H., McKenna, G. and Stiff, M., 2001. *SPECTRUM knowledge: standards for cultural information management*. (Cambridge: mda.).
- ASHRAE 2003. Museums Libraries and Archives: Chapter A21 in ASHRAE, 2003. *Handbook, HVAC Applications. SI Edition*. (Atlanta: American Society of Heating Refrigerating and Air-Conditioning Engineers).
- Askerud, P. & Clement, E. (Editors), 1977. *Preventing the Illicit Traffic in Cultural Property. A Resource Handbook for the Implementation of the 1970 UNESCO Convention*. (Paris: UNESCO).
- Bachmann, K., 1992. *Conservation Concerns*. (Washington D.C.: Smithsonian Institution Press).
- Bahgli, S-A., Boylan, P.J. & Herreman, Y., 1998. *History of ICOM (1946-1996)*. (Paris: ICOM)
- Bauer, D. G., 1995. *The "How To" Grants Manual*, (Third Edition), (Phoenix, AZ: American Council on Education and Oryx Press).
- Belcher, M., (editor), 1991. *Exhibitions* (1991) (London: Leicester University Press)
- Blazek, J., 1996. *Financial Planning for Nonprofit Organizations*. (New York and Singapore: John Wiley & Sons, Inc.)
- Brodie, N. & Tubb, K.W., 2002. (Editors) *Illicit Antiquities. The theft of culture and the extinction of archaeology*. (London: Routledge).
- Brokerhof, A. 2002. Solarisation: A cheap but effective method to disinfect museum objects pp. 15 – 20 in ICOM-CC, 2002. *13th Triennial Meeting Rio de Janeiro, 22-27 September 2002*. James and James: London.
- Brüninghaus-Knubel, C., 1993. Museum educator: the audience's advocate. *Museum International* (UNESCO) vol. 180, No.4.
- Buck, R.A. and Gilmore, J. A., (Editors.), 1998. *The new museum registration methods*. (4th edition). (Washington: American Association of Museums).
- Burcaw, E.G., 1997. *Introduction to Museum Work* (1997). (Third Edition) (London: Altamira Press).
- Burke, R. & Liston D., (Editors). 1992. *Museum Security & Protection: A Handbook for Cultural Institutions*. (London: ICOM in association with Routledge).
- CIE., 2004. *Control of Damage to Museum Objects by Optical Radiation Publication. CIE 157:2004*. (Vienna: International Commission On Illumination).
- Collins, Z.W., (editor.), 1981. *Museums Adults and the Humanities. A Guide for Educational Planning*. (Washington: American Association of Museums).
- Davies, S., 1996. *MGC Guidelines for Good Practice: Producing a Forward Plan*. (London: Museums & Galleries Commission).
- Dodd, J. & Sandell, R., 1998. *Building Bridges: Guidance for museums and galleries on developing new audiences*. (London: Museums and Galleries Commission).
- Dorge, V. & Jones, S. 1999. *Building an Emergency Plan. A Guide for Museums and Other Cultural Institutions*. (Los Angeles: Getty Conservation Institute).
- Durbin, G., 1996. *Developing Museum Exhibitions for Lifelong Learning*. London: Museums & Galleries Commission).
- Edson, G. & Dean, D., 1994. *The Handbook for Museums*. (London & New York: Routledge).
- Fahy, A.,(editor), 1995. *Collections Management: Leicester Readers in Museum Studies*. (London & New York: Routledge).
- Faulk, H.F. & Durkin, L.D., 1992. *The Museums Experience* (Washington: Whalesback Books).
- García Blanco, Á., 1999. *La Exposición como medio de Comunicación* (Madrid : Ediciones Akal).
- Genoways, H. & Ireland, L., 2003. *Museum Administration*, (Walnut Creek, NY and Oxford: AltaMira Press).
- Giebenhausen, M. (Editor). 2003. *The Architecture of the Museum*.

- (Manchester: University Press).
- Giles, H. (and others), 1998. *Welcoming our visitors: How to plan successful special events*. (London: English Heritage).
- Goulding C., 2000. The museum environment and the visitor experience. *European Journal of Marketing*, vol. 34, no. 34, (16 March 2000), pp. 261-278.
- Graham, C., 1992. *Keep the Money Coming*. (Sarasota, FL: Pineapple Press).
- Hall, M., 1988). *On Display. A Design Grammar for Museum Exhibitions* (London: Lund Humphries).
- Hein, G.E., 1998. *Learning in the Museum*. (London: Routledge).
- Herreman, Y., (in press). *Museos. Introducción a su teoría y práctica*. (Mexico City: INAH/SEP).
- Hilbert, G.S. (Editor), 2000. *Vocabulary of Museum Security Terms. (Multilingual: English, French, German, Spanish, Italian)*. (Berlin, Staatliche Museen zu Berlin for ICOM International Committee for Museum Security – ICMS).
- Holm, S.A., 1998. *Facts & Artefacts: How to document a museum collection*. (2nd Edition). (Cambridge: mda).
- Holm, S.A., 2002. *Cataloguing made easy: how to catalogue your collections*. (2nd Edition). (Cambridge: Museum Documentation Association).
- Hooper-Greenhill, E., 1991. *Museum and Gallery Education*. (Leicester & New York: Leicester University Press).
- Hooper-Greenhill, E., 1992. *Museums and the Shaping of Knowledge*. (London: Routledge).
- Hooper-Greenhill, E., (Editor). (1994). *Museums and their Visitors* London: Routledge.
- Hooper-Greenhill, E., 1995. *Museums, Media, Message*. (London: Routledge).
- Hooper-Greenhill, E., 1999. *Educational Role of the Museum*. (London: Routledge).
- Hopkins, B. R., 2001. *Starting and Managing A Nonprofit Organization*. (Third Edition). (New York and Singapore: John Wiley & Sons, Inc.)
- International Committee of the Red Cross. 2002. *Protection of Cultural Property in the Event of Armed Conflict* (Geneva: ICRC).
- International Council of Museums, 1994. *Museums, Civilisations and Development: Amman, April 1994*. (Paris: ICOM) (Arabic edition also available).
- International Council of Museums, 1996. *Handbook of standards. Documenting African collections*. (English-French edition.) (Paris: ICOM). (Also available on-line at: <http://icom.museum/afridoc/>)
- International Council of Museums, 1997. *Handbook of standards. Documenting African collections*. (Arabic edition). (Tunis: ICOM-Arab)
- International Council of Museums, 2004. *ICOM Code of Ethics for Museums*. (Paris, ICOM).
- ICOM-CIDOC, 1995. *International Guidelines for Museum Object Information: The CIDOC Information Categories*. (Paris: ICOM International Committee for Documentation - CIDOC). (Also available on-line at: <http://www.cidoc.icom.org/guide/guide.htm>)
- Keene, S., 2002. *Managing Conservation in Museums* (2nd edition). (London: Butterworth-Heinemann).
- Keller, K., 2003. *Strategic Brand Management: Building, Measuring, and Managing Brand Equity*. (Upper Saddle River, N.J.: Prentice Hall).
- Knell, S.J., (editor), 1994. *Care of Collections: Leicester Readers in Museum Studies*. (London & New York: Routledge).
- Kingsley, H. et al., (editors), 2001. *Integrated Pest Management for Collections*. (London: English Heritage).
- Kotler, P. & Kotler, N., 1998. *Museum Strategy and Marketing. Designing Missions, Building Audiences, Generating Revenue and Resources*. (San Francisco: Jossey-Bass Inc.).
- Kotler, P., 2003. *Marketing Management*. (San Francisco: Jossey-Bass Inc.).
- Lancaster, G. & Reynolds, P., 2002. *Marketing Made Simple*. (Oxford: Elsevier Science).
- Lauffer, A., 1984. *Strategic Marketing for Not-for-Profit Organizations* (New York: Macmillan).
- Lord, B. & Lord, G.D. 1997. *Manual of Museum Management*. (London: Stationary Office).
- Lord, B. & Lord, G.D., (Editors), 2001. *Manual of Museum Exhibitions*. (California: AltaMira Press).
- Lord, G. D. & Lord, B., (Editors), 2001. *The Manual of Museum Planning* (Second Edition) (Walnut Creek, NY and Oxford: AltaMira Press).
- Malaro, M., 1998. *A Legal Primer on Managing Museum Collections* (2nd edition) (Washington D.C.: Smithsonian Institution Press).
- McLean, F., 1997. *Marketing the Museum* (London: Routledge).
- Michalski, S., 1997. The Lighting Decision. pp. 97 – 104 in Ottawa Textile Symposium, 1997. *Fabric of an Exhibition: An Interdisciplinary Approach*. (Ottawa: Canadian Conservation Institute).
- Michalski, S., 2000. *Guidelines for humidity and temperature in Canadian archives. Technical Bulletin No. 23*. (Ottawa: Canadian Conservation Institute).
- Moffatt, H., & Woollard, V., 2000. *Museum and Gallery Education: A Manual Of Good Practice*. (Walnut Creek, NY and Oxford: AltaMira Press).
- Mohen, J-P., 1999. *Les sciences du patrimoine : identifier, conserver,*

- restaurer. (Paris: O. Jacob).
- Museum Documentation Association, 1997. *SPECTRUM: The UK Museum Documentation Standard*. (Second Edition). (Cambridge: Museum Documentation Association).
- O'Keefe P.J., 1997. *Trade in Antiquities: Reducing Destruction and Theft* (Paris: UNESCO, London: Archetype; Paris, London).
- O'Keefe, P.J., 2000. *Commentary on the UNESCO 1970 Convention on Illicit Traffic* (Leicester: Institute of Art and Law).
- O'Keefe, P.J., 2002. *Shipwrecked Heritage: A Commentary on the UNESCO Convention on Underwater Cultural Heritage*. (Leicester: Institute of Art and Law).
- O'Keefe, P.J., 2004. The First Protocol to the Hague Convention Fifty Years On. *Art, Antiquity and Law*. vol. 9, pp. 99-116.
- Pinniger, D. 2001. *Pest management in museums, archives and historic houses*. (London: Archetype Publications).
- Prot, L.V., 1997 *Commentary on the UNIDROIT Convention 1995*. (Leicester: Institute of Art and Law).
- Raphael, T., (no date : ca.2000). *Exhibit conservation guidelines: incorporating conservation into exhibit planning, design and fabrication*. (CD-ROM: Harper's Ferry, USA: US National Park Service).
- Reussner E.M., (2003). Strategic management for visitor-oriented museums. *International Journal of Cultural Policy*, vol. 9, no. 1, (12 April 2003), pp. 95-108.
- Rose, C. L. & de Torres, A.R., 1992. *Storage of Natural History Collections: Ideas and Practical Solutions*. (Pittsburgh: Society for the Preservation of Natural History Collections).
- Rose, C.L., Hawkes, C.A. & Genoways, H., 1995. *Storage of Natural History Collections: A Preventive Conservation Approach*. (Pittsburgh: Society for the Preservation of Natural History Collections).
- Runyard, S. & French, Y., 2000. *Marketing and Public Relations Handbook for Museums, Galleries and Heritage Attractions*. (London: The Stationary Office).
- Screven, C., 1985. *Evaluación de exposiciones en de Museos*. (Mexico City: Comité Nacional Mexicano).
- Section Française de l'IIC, 2001. *Préserver les objets de son patrimoine: précis de conservation préventive*. (Paris : Sprimont Mardaga).
- Shackley, M., 2001. *Managing Sacred Sites Service Provision and Visitor Experience* (London: Continuum).
- Strang, T. 2001. Principles of heat disinfestations. pp. 114 – 129 in Kingsley, H., 2001 (*q.v.*).
- Swarbrooke, J., 2001. *Development and Management of Visitor Attractions* (Oxford: Butterworth-Heinemann).
- Tétreault, J. 1999. *Coatings for Display and Storage in Museums*. CCI Technical Bulletin, No. 21. (Ottawa: Canadian Conservation Institute).
- Tétreault, J. 2003. *Airborne Pollutants in Museums, Galleries, and Archives: Risk Assessment, Control Strategies, and Preservation Management*. (Ottawa: Canadian Conservation Institute, Ottawa).
- Thomson, G. 1986. *The Museum Environment*. (2nd edition). (Oxford: Butterworths-Heinemann). London.
- Thompson, J.M.A. (editor), 1992. *Manual of Curatorship: A Guide to Museum Practice*. (Second Edition). (Oxford: Butterworth).
- Thornes, R. (1999). *Introduction to Object ID. Guidelines for making records that describe art, antiques and antiquities*. (Santa Monica, CA.: Getty Information Institute; Oxford: OUP).
- Total, 2003. *Sharing our energies – Corporate Social Responsibility Report*. (Paris: Total).
- Velarde, G., 1989. *Designing Exhibitions. The Principles and process of Contemporary Show Space Design*. (New York: Watson-Gupill Publications).
- Verhaar J. & Han, M., 1989. *Project Model Exhibitions* (Amsterdam: Amsterdamse Hogeschool voor Kunsten).
- Waidacher, Friedrich, 1999. *Handbuch der Allgemeinen Museologie*, (Vienna: Böhlau).
- Waller, R 2003. Cultural property risk analysis model : development and application to preventive conservation at the Canadian Museum of Nature. *Göteborg studies in conservation #13*. Göteborg University, Göteborg.
- Weschenfelder, K. & Zacharias, W. 1992. *Handbuch Museumspädagogik: Orientierungen und Methoden für die Praxis*. (3rd revised edition). Düsseldorf.
- Wilson, L-A. & Boyle, E., 2004. Explaining the performance of a new public service visitor attraction shop. *International Journal of Contemporary Hospitality Management*, vol. 16, no. 5 (1 May 2004), pp. 299-308.
- Wolf, T., 1999. *Managing a Nonprofit Organization in the Twenty-First Century*. (New York: Simon & Schuster.)
- Websites with practical information and guidance (Grouped by topic)**
International Organisations and General Information
United Nations Educational, Scientific and Cultural Organisation (UNESCO): Culture Sector Home Page:

<http://www.unesco.org/culture/> This index page has links to thousands of very valuable information resources covering all of UNESCO's Cultural Sector work, grouped according to UNESCO's main cultural programme areas which are currently: World Heritage, Tangible Heritage, Intangible Heritage, Cultural Diversity, Normative Action (i.e. treaties and other legal measures), Intercultural Dialogue, Culture and Development, Cultural Industries, Arts & Creativity, Copyright, Museums, and Cultural Tourism.

International Council of Museums (ICOM): Extensive website with a wide range of resources, with links to those of all of its more than 30 specialist international committees and affiliated organisations. <http://icom.museum/>

International Council on Monuments and Sites (ICOMOS): <http://www.icomos.org/>

The International Committee of the Blue Shield (ICBS)/Comité International du Bouclier Bleu (CIBB): <http://www.ifla.org/blueshield/> The ICBS is the standing joint emergency preparedness and response committee of the four UNESCO-linked international professional organisations for archives (ICA), libraries (IFLA), monuments and sites (ICOMOS) and museums (ICOM). It works closely with UNESCO and other bodies, and now has special recognition under the 1999 Second Protocol to the Hague Convention on the Protection of Cultural Property in the Event of Armed Conflict, 1954.

International Centre for the Study of the Preservation and Restoration of Cultural Property (ICCROM): <http://www.iccrom.org/> Intergovernmental organisation that was established in Rome in 1959, with a world-wide mandate to promote the conservation of all types of cultural heritage, both movable and immovable. It currently comprises over 100 Member States, and aims at improving the quality of conservation practice as well as raising awareness about the importance of preserving cultural heritage. Its website give access to a very wide range of resources including ICCROM's Library and conservation training course databases, expert reports and other publications.

Inventories and Documentation advice:

Dublin Core Metadata Initiative (2004) :
<http://www.dublincore.org/>

International Council of Museums. International Committee for Documentation (CIDOC) (1993). *Registration step by step: when an object enters the museum. CIDOC Fact Sheet 1*. English, French and other versions. CIDOC Services Working Group. International Council of Museums. <http://www.cidoc.icom.org/fact1.htm>

International Council of Museums. International Committee for Documentation (CIDOC) (1994). *Labelling and marking objects. CIDOC Fact Sheet 2*. English, French and other versions. CIDOC Services Working Group. International Council of Museums. <http://www.cidoc.icom.org/fact2.htm>

International Council of Museums. Object ID.
<http://icom.museum/object-id>

Care and Preservation of Collections

Bibliographic Database of the Conservation Information Network. The Web's most complete bibliographic resource for the conservation, preservation and restoration of cultural property <http://www.bcin.ca>

CoOL: Conservation Online: a project of the Preservation Department of Stanford University Libraries, is a full text library of conservation information, covering a wide spectrum of topics of interest to those involved with the conservation of library, archives and museum materials. Links page to many other conservation related sites. <http://palimpsest.stanford.edu>

The Canadian Conservation Institute. Access to their library catalogue, order form for publications, and links page to many other conservation related sites. <http://www.cci-icc.gc.ca>

Center for Conservation in Quebec, Canada, A new and excellent materials database on the web, describing the uses and sources of many materials used in museum exhibits, and storage, such as encapsulation with Mylar.

<http://preservart.ccq.mcc.gouv.qc.ca>

Visitor Services:

Audience Development Plans: Practical advisory booklet

prepared by the Heritage Lottery Fund (United Kingdom) for those wishing to apply for their grants, but publicly available, and can be downloaded free of charge from its website in PDF format: <http://www.hlf.org.uk>

Visitor Study Groups:

Evaluation and Visitor Research Interest Group Australia: <http://amol.org.au/evrsig/>

Visitor Studies Association (based in the USA): <http://www.visitorstudies.org/links.htm>

Visitor Studies Group UK: <http://www.visitors.org.uk/>

Planning for the Disabled

Designing for access to buildings: For information on planning for disabled or elderly access to buildings see: http://www.cae.org.uk/sheets/designs_sheets/ramps.html

Thinking about Access, Improving your project for disabled people: Practical advisory booklet prepared by the Heritage Lottery Fund (United Kingdom) for those wishing to apply for their grants, but publicly available, and can be downloaded free of charge from its website in PDF format: <http://www.hlf.org.uk>

Access for All Toolkit: This is intended to help museums etc. to audit their current services and facilities in terms of access and overcoming social exclusion: free from the Museums Libraries and Archives Council for England (MLA). Can be downloaded in PDF and MS Word formats: http://www.mla.gov.uk/action/learnacc/00access_04.asp

“See it right” information pack of the UK’s Royal National Institute for the Blind: gives valuable information on planning for and responding to visually impaired visitors. Available online at: http://www.rnib.org.uk/xpedio/groups/public/documents/PublicWebsite/public_seeitright.hcsp

Principles of Universal Design: supported by the National Institute on Disability and Rehabilitation Research of the United States Department of Education, helps with the design of products and environments to be usable by all people, to the greatest extent possible, without the need for adaptation or

specialized design.

http://www.design.ncsu.edu/cud/univ_design/principles/udprinciples.htm

Personnel Management and Training

ICOM International Committee for the Training of Personnel: Wide-ranging resource on personnel issues, including on-line directory of training courses and programmes, and original papers and reports. <http://ictop.icom.museum/>

ICOM Curricula Guidelines for Museum Professional Development: including museum training bibliography: <http://museumstudies.si.edu/ICOM-ICTOP/index.htm>

ICCROM – Training Opportunities Directory: <http://www.iccrom.org/eng/training/opportunities.php>

Marketing

Fuel For the Arts: Remarkable global on-line resource (hosted by the Australia Council for the Arts) covering all aspects of marketing, promotion and audience/visitor for all areas of the cultural sector, with over 15,000 members in 128 countries. Free registration gives access to over 2,000 free practical resources: reports, publications, practical “how to” advice, etc. and regular e-mail newsletters. <http://www.fuel4arts.com/>

Illicit Trafficking: information and advice on missing objects:

Interpol: <http://www.interpol.int/Public/WorkOfArt/Default.asp>

The Art Loss Register: <http://www.artloss.com/>

Invaluable (Trace): <http://www.invaluable.com/stolenart/>

Brief biographies of the Authors

Patrick Boylan was Professor of Arts Policy and Management at City University London from 1990 to 2004, and was Head of Department 1990–1996. On his recent retirement the University honoured him with the title of Professor Emeritus of Heritage Policy and Management. From 1964 to 1990 he held senior positions in English museums and arts organisations, including 18 years as Director of Museums and Arts for Leicestershire. He was the Centenary President of the United Kingdom's Museums Association 1988-1990, and from 1977-2004 held a wide range of offices in ICOM, including service as an Executive Council member, Vice-President, President of the ICOM International Committee for the Training of Personnel (ICTOP), and of ICOM's United Kingdom National Committee. He has written nearly 200 publications on geology, history of science, museums, heritage, cultural policy and management.

Cornelia Brüninghaus-Knubel has been Head of the Education Department at the Wilhelm Lehbruck Museum Duisburg since 1985. In 1969 she became one of the first professional museum educators in Germany, working primarily in museums of modern art (Museum Folkwang Essen, Kunstmuseum Düsseldorf) before founding the Children's Museum at the Wilhelm Lehbruck Museum. She was Chairperson of ICOM–CECA, the International Committee for Museum Education and Cultural Action, from 1983 to 1989. From 1975 to 1982 she also taught Museum Education and Art History at the Universities of Essen and Gießen, and since 1989 she has conducted training courses in Museology and Museum Education for the Goethe Institute on many continents.

Gary Edson is Executive Director of the Museum of Texas Tech University, Director of the Center for Advanced Study of

Museum Science and Heritage Management, and Professor of Museum Science. He has been a member of the American Association of Museums (AAM) Board (1992-1994), the AAM/ICOM Board (1994-2000), and a member of the AAM/ICOM Executive Committee (1997-2000). He is an active member of the ICOM Ethics Committee (1997-2004) and has served on various other academic and museum related boards, serving on the ICOM Executive Council since 2001. He is a guest lecturer on museum administration at the Reinwardt Academy, Amsterdam, and a consultant to the University of Costa Rica Committee on Museum Development. In addition to numerous articles and papers on museology and museum ethics, he is co-author with David Dean of *The Handbook for Museums* (1994).

Yani Herreman coordinates the postgraduate course in Museum Planning and Design in the School of Architecture of the National University of Mexico. Her senior positions in several Mexican museums and cultural agencies have included Head of Design in the Museum of Cultures, Director of the Natural History Museum of Mexico City, Director of Museums, Libraries and Cultural Centres of the Mexico City Metropolitan Government, Deputy Director of Cultural Action of the Ministry of Finance, and Heritage and Cultural Action Coordinator at the Iztacala Campus of the National University. As an active architect and designer she has designed exhibitions and has actively worked on museum planning and programming in different countries. She has written on several topics related to museums, exhibitions, architecture, programming, and the relationships between museums and exhibitions and both tourism and urban planning. Within ICOM she was the founding Chair of ICOM's Latin-American Regional

Organisation, chaired the International Committee for Museum Architecture and Design, and was a member of the Executive Council and then Vice-President from 1998 to 2004.

Pavel Jirásek has been Director of the Department for the Protection of the Moveable Cultural Heritage, Museums and Galleries at the Czech Ministry of Culture since 1999. After completing his studies at the Czech Technical University he worked in industry and then at the State Institute for the Preservation of Monuments in Prague. From 1991 to 1995 he was coordinator for the protection of the moveable cultural assets against crime and natural disasters, and from 1996 to 1999 he worked for the integrated system of moveable cultural heritage at the Ministry of Culture. He has participated in a number of training courses abroad, focused on the protection and documentation of collections. Since 2001 he has chaired the ICOM International Committee for Museum Security (ICMS), and is active in projects organized by ICOM, the European Union, Czech Committee of the Blue Shield, Council of Europe, Interpol, Europol etc. He lectures and publishes on the protection and restitution of the cultural heritage.

Nicola Ladkin, Adjunct Professor in Museum Science at Texas Tech University, Lubbock, Texas, has conducted archaeological fieldwork and worked in museums in England and the USA. Successively a Lab Supervisor, Collections Manager for Anthropology, and Registrar in Museum of Texas Tech University she currently is a Senior Research Associate at the Museum. She has published and presented papers at workshops internationally, including a workshop on Collections Management and Preventive Conservation, in Aswan, Egypt on behalf of the ICOM International Campaign for the Establishment of the Nubia Museum.

Geoffrey Lewis chairs the ICOM Ethics Committee. A Past President of both ICOM and The Museums Association (UK), and former Chairman of the ICOM Advisory Committee, he directed the museums of Sheffield and Liverpool (now National Museums Liverpool) before becoming Director of Museum

Studies at the University of Leicester. He holds a research degree in archaeology and the Diploma, Fellowship and Honorary Fellowship of the Museums Association. He is also an Honorary Member of ICOM. He has published many papers on archaeology and museum studies and co-edited and was a major contributor to the Museums Association's major work, *Manual of Curatorship: A Guide to Museum Practice*.

Stefan Michalski is Senior Conservation Scientist at the Canadian Conservation Institute (CCI). He has carried out research and provided advice for over 20 years in the areas of museum environment and collection preservation. He has carried out numerous preservation surveys in museums, and taught courses in North, Central, and South America, the Caribbean, Europe, Egypt and Kuwait. He was coordinator of the ICOM Conservation Committee's Preventive Conservation Working Group for two triennials, and has an extensive list of publications. Currently he is working on a computerised knowledge base for risk assessment of collections, and a training course on risk assessment with the CCI and ICCROM for 2005.

Paal Mork has been in charge of communications and marketing at the Norsk Folkemuseum, Oslo, since 1992, where he has developed the communications strategies for the museum as a whole and for several major exhibitions. He holds a Master's degree in Ethnology and is also educated in Marketing and Communications. He has published articles and given lectures on museum marketing and communications, focussing especially on branding and strategic planning. Since 2003 he has been the Chairman of ICOM's International Committee for Museum Marketing and Public Relations (MPR), after serving as its Vice-Chairman since 2000.

Lyndel Prott is currently Adjunct Professor at the Research School for Asia and the Pacific at the Australian National University, Canberra, Australia, and was previously the Director of the Cultural Heritage Division of UNESCO, Paris. She holds degrees in Law and Arts from the Universities of Sydney and Tübingen, Germany, and the Free University of Brussels. She has

had wide experience of cultural heritage law, including negotiations for international legal instruments to restrain illegal traffic and their practical implementation in many countries of the world. She has written about 250 publications on cultural heritage law, comparative law, international law and jurisprudence, including the key *Commentary on the UNIDROIT Convention*, and she is publishing in five volumes, with her co-author Patrick O'Keefe, the seminal work in this subject *Law and the Cultural Heritage*. A member of ICOM for over two decades, her work has been recognized by the award of the distinctions of Officer of the Order of Australia, the Austrian Cross of Honour for Science and the Arts (First Class) and an LL.D. (honoris causa) from the University of Sydney.

Andrew Roberts has been involved with museum documentation for thirty years, and is actively committed to the development of the standards and systems now in use in many museums. He worked for the Museum Documentation Association (MDA) from 1974-1991, where his responsibilities included providing advice and training, developing publications, organising conferences and developing museum documentation standards. In 1993 he joined the Museum of London where his responsibilities included the management and use of collection information and associated resources. He has been an active member of the International Committee for Documentation (ICOM-CIDOC) since 1976, including six years as Chair of the Committee from 1989-1995. He was also an advisor on the AFRICOM project, developing and implementing documentation standards for African museums.

Vicky Woollard, Senior Lecturer in the Department of Cultural Policy and Management, City University London, is currently the Programme Director of the MA in Museum and Gallery Management. She was previously education officer for eighteen years within three London Museums and also lecturer / consultant to museums and heritage agencies in England, South America, Sarawak, Finland, Papua New Guinea, Colombia and Latvia. She was co-Director of three British Council International Seminars,

and co author of *Museum and Gallery Education: A Manual of Good Practice* (1999). She also takes an active part in the Museums Association and is a Board member for the Women's Library and the Group for Education in Museums. Her academic interests are in museum and gallery education and the continuing professional development of museum professionals.

ICOM Code of Professional Ethics

INTRODUCTION

This edition of the *ICOM Code of Ethics for Museums* is the culmination of six years' revision. Following a thorough review of the ICOM's Code in the light of contemporary museum practice, a revised version, structured on the earlier edition, was issued in 2001. As envisaged at that time, this has now been completely reformatted to give it the look and feel of the museum profession and is based on key principles of professional practice, elaborated to provide general ethical guidance. The *Code* has been the subject of three periods of consultation with the membership. It was approved at the 21st General Assembly of ICOM, Seoul in 2004 with acclamation.

The whole ethos of the document continues to be that of service to society, the community, the public and its various constituencies, and the professionalism of museum practitioners. While there is a changed emphasis throughout the document resulting from the new structure, the accentuation of key points and the use of shorter paragraphs, very little is totally new. The new features will be found in paragraph 2.11 and the principles outlined in sections 3, 5 and 6.

The *Code of Ethics for Museums* provides a means of professional self-regulation in a key area of public provision where legislation at a national level is variable and far from consistent. It sets minimum standards of conduct and performance to which museum professional staff throughout the world may reasonably aspire and provides a statement of reasonable public expectation from the museum profession.

ICOM issued its *Ethics of Acquisition* in 1970 and a full *Code of Professional Ethics* in 1986. The present edition – and its interim document of 2001 – owe much to that early work. The

major work of revision and restructuring, however, fell on the current members of the Ethics Committee and their contribution in meetings – both actual and electronic – and their determination to meet both target and schedule is gratefully acknowledged. Their names are listed below.

Like its precursors, the present *Code* provides a global minimum standard on which national and specialist groups can build to meet their particular requirements. ICOM encourages the development of national and specialist codes of ethics to meet particular needs and will be pleased to receive copies of them. These should be sent to the Secretary-General of ICOM, Maison de l'UNESCO, 1 rue Miollis, 75732 Paris Cedex 15, France. E-mail: secretariat@icom.org

Geoffrey Lewis

Chair, ICOM Ethics Committee

ICOM Ethics Committee for the period 2001-2004

Chair: Geoffrey Lewis (UK)

Members: Gary Edson (USA); Per Kåks (Sweden); Byung-mo Kim (Republic of Korea); Pascal Makambila (Congo) – from 2002; Jean-Yves Marin (France); Bernice Murphy (Australia) – to 2002; Tereza Scheiner (Brazil); Shaje'a Tshiluila (Democratic Republic of Congo); Michel Van-Praët (France).

PREAMBLE

Status of the Code of Ethics for Museums

This *Code of Ethics for Museums* has been prepared by the International Council of Museums. It is the statement of ethics for museums referred to in the ICOM Statutes. This Code reflects principles generally accepted by the international museum

community. Membership of ICOM and the payment of the annual subscription to ICOM is an affirmation of this *Code of Ethics*.

A Minimum Standard for Museums

This *Code* represents a minimum standard for museums. It is presented as a series of principles supported by guidelines of desirable professional practice. In some countries certain minimum standards are defined by law or government regulation. In others, guidance on and assessment of minimum professional standards may be available in the form of 'Accreditation', 'Registration' or similar evaluative schemes. Where such standards are not defined, guidance can be obtained through the ICOM Secretariat, the National Committee of ICOM, or the appropriate International Committee of ICOM. It is also intended that individual nations and the specialised subject organisations connected with museums should use this Code as a basis for developing additional standards.

Translations of the Code of Ethics for Museums

The *ICOM Code of Ethics for Museums* is published in three versions: English, French and Spanish. ICOM welcomes the translation of the Code into other languages. However, a translation will be regarded as "official" only if it is endorsed by at least one national committee of a country in which the language is spoken, normally as the first language. Where the language is spoken in more than one country it is preferable that the national committees of these countries should also be consulted. Attention is drawn to the need for linguistic as well as professional expertise in providing official translations. The language version used for the translation and the names of the national committees involved should be indicated. These conditions do not restrict translations of the Code, or parts of it, for use in educational work or for study purposes.

SECTIONS

1. Museums preserve, interpret and promote aspects of the natural and cultural inheritance of humanity.
 - Institutional standing
 - Physical resources
 - Financial resources
 - Personnel
2. Museums that maintain collections hold them in trust for the benefit of society and its development.
 - Acquiring collections
 - Removing collections
 - Care of collections
3. Museums hold primary evidence for establishing and furthering knowledge.
 - Primary evidence
 - Museum collecting & research
4. Museums provide opportunities for the appreciation, enjoyment, understanding and management of the natural and cultural heritage.
 - Display and exhibition
 - Other resources
5. Museum resources provide opportunities for other public services and benefits.
 - Identification services
6. Museums work in close collaboration with the communities from which their collections originate as well as those they serve.
 - Origin of collections
 - Respect for communities served
7. Museums operate in a legal manner.
 - Legal framework
8. Museums operate in a professional manner.
 - Professional conduct
 - Conflicts of interest

Glossary for Code of Ethics

Appraisal:

The authentication and valuation of an object or specimen. In certain countries the term is used for an independent assessment of a proposed gift for tax benefit purposes.

Conflict of interest:

The existence of a personal or private interest which gives rise to a clash of principle in a work situation, thus restricting, or having the appearance of restricting, the objectivity of decision making.

Dealing:

Buying and selling items for personal or institutional gain.

Due diligence:

The requirement that every endeavour is made to establish the facts of a case before deciding a course of action, particularly in identifying the source and history of an item offered for acquisition or use before accepting it.

Conservator-Restorer:

Museum or independent personnel competent to undertake the technical examination, preservation, conservation and restoration of cultural property. For further information see *ICOM News* 39 (1), pp 5-6 (1986)

Cultural Heritage:

Any thing or concept considered of aesthetic, historical, scientific or spiritual significance.

Governing Body:

The persons or organisations defined in the enabling legislation of the museum as responsible for its continuance, strategic development and funding.

Income-generating activities:

Activities intended to bring financial gain or profit for the benefit of the institution.

Legal title:

Legal right to ownership of property in the country concerned. In certain countries this may be a conferred right and insufficient to meet the requirements of a due diligence search.

Minimum Standard:

A standard to which it is reasonable to expect all museums and museum personnel to aspire. Certain countries have their own statements of minimum standards.

Natural Heritage:

Any natural thing, phenomenon or concept, considered to be of scientific significance or to be a spiritual manifestation.

Museum:¹

A museum is a non-profit making permanent institution in the service of society and of its development, open to the public, which acquires, conserves, researches, communicates and exhibits, for purposes of study, education and enjoyment, the tangible and intangible evidence of people and their environment.

Museum professional:¹

Museum professionals consist of the personnel (whether paid or unpaid) of museums or institutions as defined in Article 2, paras. 1 and 2, of the Statutes, who have received specialised training, or possess an equivalent practical experience in any field relevant to the management and operations of a museum, and independent persons respecting the ICOM Code of Ethics for Museums and working for museums or institutions as defined in the Statute quoted above, but not persons promoting or dealing with commercial products and equipment required for museums and museum services.

Non-profit organisation:

A legally established body, corporate or unincorporated, whose income (including any surplus or profit) is used solely for the benefit of that body and its operation. The term *Not for profit* has the same meaning.

Provenance:

The full history and ownership of an item from the time of its discovery or creation to the present day, from which authenticity and ownership is determined.

Valid title:

Indisputable right to ownership of property, supported by full provenance of the item from discovery or production.

¹ It should be noted that the terms “museum” and “museum professional” are interim definitions for use in interpreting the ICOM Code of Ethics for Museums. The definitions of “museum” and “professional museum workers” used in the ICOM Statutes remain in force until the revision of that document has been completed.

1. Museums preserve, interpret and promote the natural and cultural inheritance of humanity.

Principle: Museums are responsible for the tangible and intangible natural and cultural heritage. Governing bodies and those concerned with the strategic direction and oversight of museums have a primary responsibility to protect and promote this heritage as well as the human, physical and financial resources made available for that purpose.

INSTITUTIONAL STANDING

1.1 Enabling documentation

The governing body should ensure that the museum has a written and published constitution, statute or other public document, in accordance with national laws which clearly states the museum’s legal status, mission, permanence, and non-profit nature.

1.2 Statement of the Mission, Objectives, and Policies

The governing body should prepare, publicise and be guided by a statement of the mission, objectives, and policies of the museum and of the role and composition of the governing body.

PHYSICAL RESOURCES

1.3 Premises

The governing body should ensure adequate premises with a suitable environment for the museum to fulfil the basic functions defined in its mission.

1.4 Access

The governing body should ensure that the museum and its collections are available to all during reasonable hours and for regular periods. Particular regard should be given to those persons with special needs.

1.5 Health and Safety

The governing body should ensure that institutional standards of health, safety, and accessibility apply to its personnel and visitors.

1.6 Protection Against Disasters

The governing body should develop and maintain policies to protect the public and personnel, the collections and other resources, against natural and man-made disasters.

1.7 Security Requirements

The governing body should ensure appropriate security to protect collections against theft or damage in displays, exhibitions, working or storage areas, and while in transit.

1.8 Insurance & Indemnity

Where commercial insurance is used for collections, the governing body should ensure that the cover is adequate and includes objects in transit or on loan and other items currently the responsibility of the museum. When an indemnity scheme is in use, it is necessary that material not in the ownership of the museum is adequately covered.

FINANCIAL RESOURCES

1.9 Funding

The governing body should ensure that there are sufficient funds to carry out and develop the activities of the museum. All funds must be accounted for in a professional manner.

1.10 Income-generating Policy

The governing body should have a written policy regarding sources of income that it may generate through its activities or accept from outside sources. Regardless of funding source, museums should maintain control of the content and integrity of their programmes, exhibitions and activities. Income-generating activities should not compromise the standards of the institution or its public (See 6.6).

PERSONNEL

1.11 Employment Policy

The governing body should ensure that all action concerning personnel is taken in accordance with the policies of the

museum as well as the proper and legal procedures.

1.12 Appointment of the Director or Head

The director or head of the museum is a key post and when making an appointment, governing bodies should have regard for the knowledge and skills required to fill the post effectively. These qualities should include adequate intellectual ability and professional knowledge, complemented by a high standard of ethical conduct.

1.13 Access to Governing Bodies

The director or head of a museum should be directly responsible, and have direct access, to the relevant governing bodies.

1.14 Competence of Museum Personnel

The employment of qualified personnel with the expertise required to meet all responsibilities is necessary. (See also 2.18; 2.24; 8.12).

1.15 Training of Personnel

Adequate opportunities for the continuing education and professional development of all museum personnel should be arranged to maintain an effective workforce.

1.16 Ethical Conflict

The governing body should never require museum personnel to act in a way that could be considered to conflict with the provisions of this *Code of Ethics*, or any national law or specialist code of ethics.

1.17 Museum Personnel and Volunteers

The governing body should have a written policy on volunteer work which promotes a positive relationship between volunteers and members of the museum profession.

1.18 Volunteers and Ethics

The governing body should ensure that volunteers, when conducting museum and personal activities, are fully conversant with the *ICOM Code of Ethics* and other applicable codes and laws.

2. Museums that maintain collections hold them in trust for the benefit of society and its development.

Principle: *Museums have the duty to acquire, preserve and promote their collections as a contribution to safeguarding the natural,*

cultural and scientific heritage. Their collections are a significant public inheritance, have a special position in law and are protected by international legislation. Inherent in this public trust is the notion of stewardship that includes rightful ownership, permanence, documentation, accessibility and responsible disposal.

ACQUIRING COLLECTIONS

2.1 Collections Policy

The governing body for each museum should adopt and publish a written collections policy that addresses the acquisition, care and use of collections. The policy should clarify the position of any material that will not be catalogued, conserved, or exhibited (See 2.7; 2.8).

2.2 Valid Title

No object or specimen should be acquired by purchase, gift, loan, bequest, or exchange unless the acquiring museum is satisfied that a valid title is held. Evidence of lawful ownership in a country is not necessarily valid title.

2.3 Provenance and Due Diligence

Every effort must be made before acquisition to ensure that any object or specimen offered for purchase, gift, loan, bequest, or exchange has not been illegally obtained in or exported from, its country of origin or any intermediate country in which it might have been owned legally (including the museum's own country). Due diligence in this regard should establish the full history of the item from discovery or production.

2.4 Objects and Specimens from Unauthorised or Unscientific Fieldwork

Museums should not acquire objects where there is reasonable cause to believe their recovery involved the unauthorised, unscientific, or intentional destruction or damage of monuments, archaeological or geological sites, or species and natural habitats. In the same way, acquisition should not occur if there has been a failure to disclose the finds to the owner or occupier of the land, or to the proper legal or governmental authorities.

2.5 Culturally Sensitive Material

Collections of human remains and material of sacred significance

should be acquired only if they can be housed securely and cared for respectfully. This must be accomplished in a manner consistent with professional standards and the interests and beliefs of members of the community, ethnic or religious groups from which the objects originated, where known (See also 3.7; 4.3).

2.6 *Protected Biological or Geological Specimens*

Museums should not acquire biological or geological specimens that have been collected, sold, or otherwise transferred in contravention of local, national, regional or international law or treaty relating to wildlife protection or natural history conservation.

2.7 *Living Collections*

When the collections include live botanical and zoological specimens, special considerations should be made for the natural and social environment from which they are derived as well as any local, national, regional or international law, or treaty relating to wildlife protection or natural history conservation

2.8 *Working Collections*

The collections policy may include special considerations for certain types of working collection where the emphasis is on preserving cultural, scientific or technical process rather than the object, or where objects or specimens are assembled for regular handling and teaching purposes (See also 2.1).

2.9 *Acquisition Outside Collections Policy*

The acquisition of objects or specimens outside the museum's stated policy should only be made in exceptional circumstances. The governing body should consider the professional opinions available to them, and the views of all interested parties. Consideration will include the significance of the object or specimen including its context in the cultural or natural heritage, and the special interests of other museums collecting such material. However, even in these circumstances, objects without a valid title should not be acquired (See also 3.4).

2.10 *Acquisition by Members of the Governing Body and Museum Personnel*

Special care is required in considering any item, either for sale, as a donation or as a tax-benefit gift, from members of governing

bodies, museum personnel, or the families and close associates of these persons.

2.11 *Repositories of Last Resort*

Nothing in this *Code of Ethics* should prevent a museum from acting as an authorised repository for unprovenanced, illicitly collected or recovered specimens and objects from the territory over which it has lawful responsibility.

REMOVING COLLECTIONS

2.12 *Legal or Other Powers of Disposal*

Where the museum has legal powers permitting disposals, or has acquired objects subject to conditions of disposal, the legal or other requirements and procedures must be complied with fully. When the original acquisition was subject to mandatory or other restrictions these conditions must be observed unless it can be shown clearly that adherence to such restrictions is impossible or substantially detrimental to the institution and, if appropriate, relief obtained through legal procedures.

2.13 *Deaccessioning from Museum Collections*

The removal of an object or specimen from a museum collection must only be undertaken with a full understanding of the significance of the item, its character (whether renewable or non-renewable), legal standing, and any loss of public trust that might result from such action.

2.14 *Responsibility for Deaccessioning*

The decision to deaccession should be the responsibility of the governing body acting in conjunction with the director of the museum and the curator of the collection concerned. Special arrangements may apply to working collections (See 2.7; 2.8).

2.15 *Disposal of Objects Removed from the Collections*

Each museum should have a policy defining authorised methods for permanently removing an object from the collections through donation, transfer, exchange, sale, repatriation, or destruction, and that allows the transfer of unrestricted title to the receiving agency. Complete records must be kept of all deaccessioning decisions, the objects involved, and the disposition of the object.

There will be a strong presumption that a deaccessioned item should first be offered to another museum.

2.16 Income from Disposal of Collections

Museum collections are held in public trust and may not be treated as a realisable asset. Money or compensation received from the de-accessioning and disposal of objects and specimens from a museum collection should be used solely for the benefit of the collection and usually for acquisitions to that collection.

2.17 Purchase of Deaccessioned Collections

Museum personnel, the governing body, or their families or close associates, should not be permitted to purchase objects that have been deaccessioned from a collection for which they are responsible.

CARE OF COLLECTIONS

2.18 Collection Continuity

The museum should establish and apply policies to ensure that their collections (both permanent and temporary) and associated information, properly recorded, are available for current usage and will be passed on to future generations in as good and safe a condition as practicable, having regard to current knowledge and resources.

2.19 Delegation of Collection Responsibility

Professional responsibilities involving the care of the collections should be assigned to persons with the appropriate knowledge and skill or who are adequately supervised (See also 8.11).

2.20 Documentation of Collections

Museum collections should be documented according to accepted professional standards. This documentation should include a full identification and description of each item, its associations, provenance, condition, treatment and present location. Such data should be kept in a secure environment and be supported with retrieval systems providing access to the information by the museum personnel and other legitimate users.

2.21 Protection Against Disasters

Careful attention should be given to the development of policies to protect the collections during armed conflict and other man-made and natural disasters

2.22 Security of Collection and Associated Data

The museum should exercise control to avoid disclosing sensitive personal or related information and other confidential matters when collection data are made available to the public.

2.23 Preventive Conservation

Preventive conservation is an important element of museum policy and collections care. It is an essential responsibility of members of the museum profession to create and maintain a protective environment for the collections in their care, whether in store, on display or in transit.

2.24 Collection Conservation and Restoration

The museum should carefully monitor the condition of collections to determine when an object or specimen may require conservation-restoration work and the services of a qualified conservator-restorer. The principle goal should be the stabilisation of the object or specimen. All conservation procedures should be documented and as reversible as possible, and all alterations should be clearly identifiable from the original object or specimen.

2.25 Welfare of Live Animals

A museum that maintains living animals should assume full responsibility for their health and well-being. It should prepare and implement a safety code for the protection of its personnel and visitors, as well as the animals, that has been approved by an expert in the veterinary field. Genetic modification should be clearly identifiable.

2.26 Personal Use of Museum Collections

Museum personnel, the governing body, their families, close associates, or others should not be permitted to expropriate items from the museum collections, even temporarily, for any personal use.

3. Museums hold primary evidence for establishing and furthering knowledge.

Principle: *Museums have particular responsibilities to all for the care, accessibility and interpretation of primary evidence collected and held in their collections.*

PRIMARY EVIDENCE

3.1 *Collections as Primary Evidence.*

The museum collections policy should indicate clearly the significance of collections as primary evidence. The policy should verify that this is not governed by current intellectual trends or museum usage.

3.2 *Availability of Collections*

Museums have a particular responsibility for making collections and all relevant information available as freely as possible, having regard to restraints arising for reasons of confidentiality and security.

MUSEUM COLLECTING & RESEARCH

3.3 *Field Collecting*

Museums undertaking field collecting should develop policies consistent with academic standards and applicable national and international laws and treaty obligations. Fieldwork should only be undertaken with respect and consideration for the views of local communities, their environmental resources and cultural practices as well as efforts to enhance the cultural and natural heritage.

3.4 *Exceptional Collecting of Primary Evidence*

In very exceptional cases an item without provenance may have such an inherently outstanding contribution to knowledge that it would be in the public interest to preserve. The acceptance of such an item into a museum collection should be the subject of a decision by specialists in the discipline concerned and without national or international prejudice (See also 2.11).

3.5 *Research*

Research by museum personnel should relate to the museum's mission and objectives and conform to established legal, ethical and academic practices.

3.6 *Destructive Analysis*

When destructive analytical techniques are undertaken a complete record of the material analysed, the outcome of the analysis, and the resulting research, including publications, should become a part of the permanent record of the object.

3.7 *Human Remains and Material of Sacred Significance*

Research on human remains and materials of sacred significance

must be accomplished in a manner consistent with professional standards and taking into account the interests and beliefs of the community, ethnic or religious groups from whom the objects originated where these are known (See also 2.5; 4.3).

3.8 *Retention of Rights to Research Materials*

When museum personnel prepare material for presentation or to document field investigation there must be clear agreement with the sponsoring museum regarding all rights to the work.

3.9 *Shared Expertise*

Members of the museum profession have an obligation to share their knowledge and experience with colleagues, scholars and students in relevant fields. They should respect and acknowledge those from whom they have learned and should pass on such advancements in techniques and experience that may be of benefit to others.

3.10 *Co-operation Between Museums & Other Institutions*

Museum personnel should acknowledge and endorse the need for co-operation and consultation between institutions with similar interests and collecting practices. This is particularly so with institutes of higher education and certain public utilities where research may generate important collections for which there is no long term security.

4. Museums provide opportunities for the appreciation, understanding and promotion of the natural and cultural heritage.

Principle: Museums have an important duty to develop their educational role and attract wider audiences from the community, locality, or group they serve. Interaction with the constituent community and promotion of their heritage is an integral part of the educational role of the museum.

DISPLAY & EXHIBITION

4.1 *Displays, Exhibitions and Special Activities*

Displays and temporary exhibitions, physical or electronic, should be in accordance with the stated mission, policy and

purpose of the museum. They should not compromise either the quality or the proper care and conservation of the collections.

4.2 Interpretation of Exhibits

Museums should ensure that the information they present in displays and exhibitions is well-founded, accurate and gives appropriate consideration to represented groups or beliefs.

4.3 Exhibition of Sensitive Materials

Human remains and materials of sacred significance must be displayed in a manner consistent with professional standards and, where known, taking into account the interests and beliefs of members of the community, ethnic or religious groups from whom the objects originated. They must be presented with great tact and respect for the feelings of human dignity held by all peoples.

4.4 Removal from Public Display

Requests for removal from public display of human remains or material of sacred significance from the originating communities must be addressed expeditiously with respect and sensitivity. Requests for the return of such material should be addressed similarly. Museum policies should clearly define the process for responding to such requests.

4.5 Display of Unprovenanced Material

Museums should avoid displaying or otherwise using material of questionable origin or lacking provenance. They should be aware that such displays or usage can be seen to condone and contribute to the illicit trade in cultural property.

OTHER RESOURCES

4.6 Publication

Information published by museums, by whatever means, should be well-founded, accurate and give responsible consideration to the academic disciplines, societies, or beliefs presented. Museum publications should not compromise the standards of the institution.

4.7 Reproductions

Museums should respect the integrity of the original when replicas, reproductions, or copies of items in the collection are made. All such copies should be permanently marked as facsimiles.

5. Museum resources provide opportunities for other public services and benefits.

Principle: Museums use a wide variety of specialisms, skills and physical resources which have a far wider application than in the museum. This may lead to shared resources or the provision of services as an extension of the museum's activities. They should be organised in such a way that they do not compromise the museum's stated mission.

IDENTIFICATION SERVICES

5.1 Identification of Illegally or Illicitly Acquired Objects

Where museums provide an identification service, they should not act in any way that could be regarded as benefiting from such activity, directly or indirectly. The identification and authentication of objects that are believed or suspected to have been illegally or illicitly acquired, transferred, imported or exported should not be made public until the appropriate authorities have been notified.

5.2 Authentication and Valuation (Appraisal)

Valuations may be made for the purposes of insurance of museums collections. Opinions on the monetary value of other objects should only be given on official request, from other museums, or competent legal, governmental or other responsible public authorities. However, when the museum may be the beneficiary, appraisal of an object or specimen must be undertaken independently.

6. Museums work in close collaboration with the communities from which their collections originate as well as those they serve.

Principle: Museum collections reflect the cultural and natural heritage of the communities from which they have been derived. As such they have a character beyond that of ordinary property which may include strong affinities with national, regional, local, ethnic, religious or political identity. It is important therefore that museum policy is responsive to this possibility.

ORIGIN OF COLLECTIONS

6.1 *Co-operation*

Museums should promote the sharing of knowledge, documentation and collections with museums and cultural organisations in the countries and communities of origin. The possibility of developing partnerships with museums in countries or areas that have lost a significant part of their heritage should be explored.

6.2 *Return of Cultural Property*

Museums should be prepared to initiate dialogues for the return of cultural property to a country or people of origin. This should be undertaken in an impartial manner, based on scientific, professional and humanitarian principles as well as applicable local, national and international legislation, in preference to action at a governmental or political level.

6.3 *Restitution of Cultural Property*

When a country or people of origin seek the restitution of an object or specimen that can be demonstrated to have been exported or otherwise transferred in violation of the principles of international and national conventions, and shown to be part of that country's or people's cultural or natural heritage, the museum concerned should, if legally free to do so, take prompt and responsible steps to co-operate in its return.

6.4 *Cultural Objects From an Occupied Country*

Museums should abstain from purchasing or acquiring cultural objects from an occupied territory and respect fully all laws and conventions that regulate the import, export and transfer of cultural or natural materials.

RESPECT FOR COMMUNITIES SERVED

6.5 *Contemporary Communities*

Where museum activities involve a contemporary community or its heritage, acquisitions should only be made based on informed and mutual consent without exploitation of the owner or informants. Respect for the wishes of the community involved should be paramount.

6.6 *Funding of Community Facilities*

When seeking funds for activities involving contemporary communities, their interests should not be compromised (See 1.10).

6.7 *Use of Collections from Contemporary Communities*

Museum usage of collections from contemporary communities requires respect for human dignity and the traditions and cultures that use them. Such collections should be used to promote human well-being, social development, tolerance, and respect by advocating multi-social, multicultural and multilingual expression (See 4.3).

6.8 *Supporting Organisations in the Community*

Museums should create a favourable environment for community support (eg Friends of Museums and other supporting organisations), recognise its contribution and promote a harmonious relationship between the community and museum personnel.

7. **Museums operate in a legal manner.**

Principle: *Museums must conform fully to international, regional, national, or local legislation and treaty obligations. In addition, the governing body should comply with any legally binding trusts or conditions relating to any aspect of the museum, its collections and operations.*

LEGAL FRAMEWORK

7.1 *National and Local Legislation.*

Museums should conform to all national and local laws and respect the legislation of other states as they affect their operation.

7.2 *International Legislation*

Museum policy should acknowledge the following international legislation which is taken as a standard in interpreting the *ICOM Code of Ethics*:

Unesco Convention for the Protection of Cultural Property in the Event of Armed Conflict (The Hague Convention, First Protocol, 1954 and Second Protocol, 1999);

Unesco Convention on the Means of Prohibiting and Preventing the Illicit Import, Export and Transfer of

Ownership of Cultural Property (1970);
Convention on International Trade in Endangered Species of Wild Fauna and Flora (1973);
UN Convention on Biological Diversity (1992);
Unidroit Convention on Stolen and Illegally Exported Cultural Objects (1995);
Unesco Convention on the protection of the Underwater Cultural Heritage (2001);
Unesco Convention for the Safeguarding of the Intangible Cultural Heritage (2003).

8. Museums operate in a professional manner.

Principle: *Members of the museum profession should observe accepted standards and laws and uphold the dignity and honour of their profession. They should safeguard the public against illegal or unethical professional conduct. Every opportunity should be used to inform and educate the public about the aims, purposes, and aspirations of the profession to develop a better public understanding of the contributions of museums to society.*

PROFESSIONAL CONDUCT

8.1 Familiarity with Relevant Legislation

Every member of the museum profession should be conversant with relevant international, national and local legislation and the conditions of their employment. They should avoid situations that could be construed as improper conduct.

8.2 Professional Responsibility

Members of the museum profession have an obligation to follow the policies and procedures of their employing institution. However, they may properly object to practices that are perceived to be damaging to a museum or the profession and matters of professional ethics.

8.3 Professional Conduct

Loyalty to colleagues and to the employing museum is an important professional responsibility and must be based on allegiance to fundamental ethical principles applicable to the

profession as a whole. They should comply with the terms of the *ICOM Code of Ethics* and be aware of any other codes or policies relevant to museum work.

8.4 Academic and Scientific Responsibilities

Members of the museum profession should promote the investigation, preservation, and use of information inherent in the collections. They should, therefore, refrain from any activity or circumstance that might result in the loss of such academic and scientific data.

8.5 The Illicit Market

Members of the museum profession should not support the illicit traffic or market in natural and cultural property, directly or indirectly.

8.6 Confidentiality

Members of the museum profession must protect confidential information obtained during their work. In addition, information about items brought to the museum for identification is confidential and should not be published or passed to any other institution or person without specific authorisation from the owner.

8.7 Museum and Collection Security

Information about the security of the museum or of private collections and locations visited during official duties must be held in strict confidence by museum personnel.

8.8 Exception to the Obligation for Confidentiality

Confidentiality is subject to a legal obligation to assist the police or other proper authorities in investigating possible stolen, illicitly acquired, or illegally transferred property.

8.9 Personal Independence

While members of a profession are entitled to a measure of personal independence, they must realise that no private business or professional interest can be wholly separated from their employing institution.

8.10 Professional Relationships

Members of the museums profession form working relationships with numerous other persons within and outside the museum in

which they are employed. They are expected to render their professional services to others efficiently and to a high standard.

8.11 Professional Consultation

It is a professional responsibility to consult other colleagues within or outside the museum when the expertise available is insufficient in the museum to ensure good decision-making.

CONFLICTS OF INTEREST

8.12 Gifts, Favours, Loans, or Other Personal Benefits

Museum employees must not accept gifts, favours, loans, or other personal benefits that may be offered to them in connection with their duties for the museum. Occasionally professional courtesies may include the giving and receiving of gifts but this should always take place in the name of the institution concerned.

8.13 Outside Employment or Business Interests

Members of the museum profession, although entitled to a measure of personal independence, must realise that no private business or professional interest can be wholly separated from their employing institution. They should not undertake other paid employment or accept outside commissions that are in conflict with, or may be viewed as being in conflict with the interests of the museum.

8.14 Dealing in Natural or Cultural Heritage

Members of the museum profession should not participate directly or indirectly in dealing (buying or selling for profit), in the natural or cultural heritage.

8.15 Interaction with Dealers

Museum professionals should not accept any gift, hospitality, or any form of reward from a dealer, auctioneer, or other person as an inducement to purchase or dispose of museum items, or to take or refrain from taking official action. Furthermore, a museum professional should not recommend a particular dealer, auctioneer, or appraiser to a member of the public.

8.16 Private Collecting

Members of the museum profession should not compete with their institution either in the acquisition of objects or in any

personal collecting activity. An agreement between the museum professional and the governing body concerning any private collecting must be formulated and scrupulously followed.

8.17 Use of the Name and Logo of ICOM

Members of ICOM may not use of the words “International Council of Museums”, “ICOM” or its logo to promote or endorse any for-profit operation or product.

8.18 Other Conflicts of Interest

Should any other conflict of interest develop between an individual and the museum, the interests of the museum should prevail.