

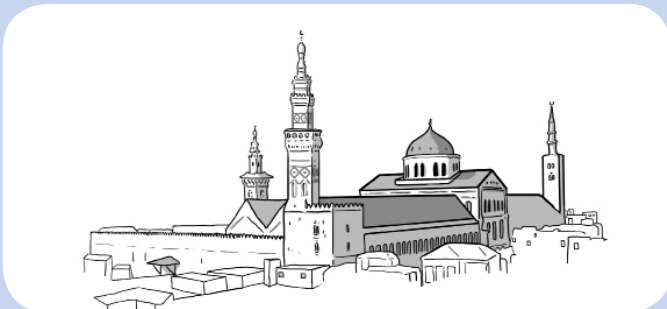

United Nations
Educational, Scientific and
Cultural Organization

SECURING HERITAGE OF RELIGIOUS INTEREST

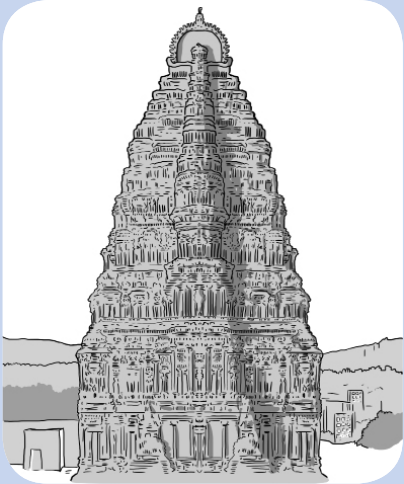

SECURING HERITAGE OF RELIGIOUS INTEREST

Cultural Heritage Protection Handbook

No. 6

Reproduction is authorized, providing that appropriate mention is made of the source, and that a copy is sent to UNESCO (1 rue Miollis, 75015 Paris, France). This document should be cited as: © UNESCO, 2012. Cultural Heritage Protection Handbook No. 6. Securing Heritage of Religious Interest, UNESCO, Paris.

Editor: Nao Hayashi-Denis assisted by Minji Song and Hiba Abid

Text by: Stéphane Thefo (Criminal Intelligence Officer, Works of Art Unit, Drugs and Criminal Organizations Sub-Directorate, INTERPOL)

With the support of Edouard Planche (UNESCO)

Drawings and layout by: Julie Blanchin (julieblanchin.com)

© UNESCO 2012

CLT/2011/PI/H/2

ISBN: 978-92-3-001074-4

Throughout the world, heritage of religious interest arouses the greed of thieves and art traffickers.

Such objects are not only sacred to the population groups concerned but are also often of artistic and historical interest.

It is therefore absolutely necessary to preserve this heritage from malicious acts.

A number of steps can be taken to minimize the likelihood of such acts against heritage.

One major challenge is to make people, particularly young people, aware of the value of heritage of religious interest.

INTRODUCTION

.....

This handbook is intended for all people (religious figures, the faithful, managers and owners) who are in contact with heritage of religious interest and wish to protect it more effectively from malicious acts (theft, vandalism, intrusion, even arson and terrorism).

It contains general advice, applicable to places of worship of various kinds and of different denominations, which is practiced in most cases.

However, as each site of religious interest has its own characteristics, some measures recommended cannot be adapted in all cases.

Heritage of religious interest is often very vulnerable. It is nevertheless always possible to protect this heritage more effectively from prejudicial acts.

A CRUCIAL PREREQUISITE: THE INVENTORY

.....

1

Compile an inventory of all items present in the building, with detailed descriptions and good quality photographs to allow the identification of an object for recovery, in case of theft. Such an inventory is absolutely essential (see the practical guide to documentation and the “Object-ID” standard available on the UNESCO website).



2

Maintain an up-to-date inventory and keep several paper, and if possible, digital copies, in various secure locations.



MEASURES REQUIRED TO ENSURE THE SECURITY OF A SITE

.....

3

Conduct a risk analysis and consider the following questions: "Are any items valuable?" "Are some items more likely to be stolen than others?" "Are they easy to steal?" On the basis of such an analysis, risk levels can be assessed and risk-reduction measures can be considered for implementation.



4

Design protection measures that both complicate and deter theft.

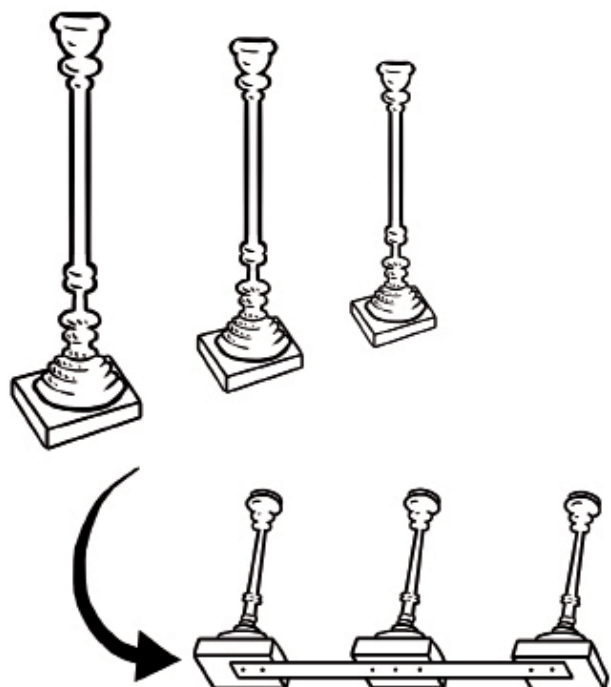

5

Site security requires “logic” and “pragmatism”. The simplest and least expensive solutions are often the most effective.

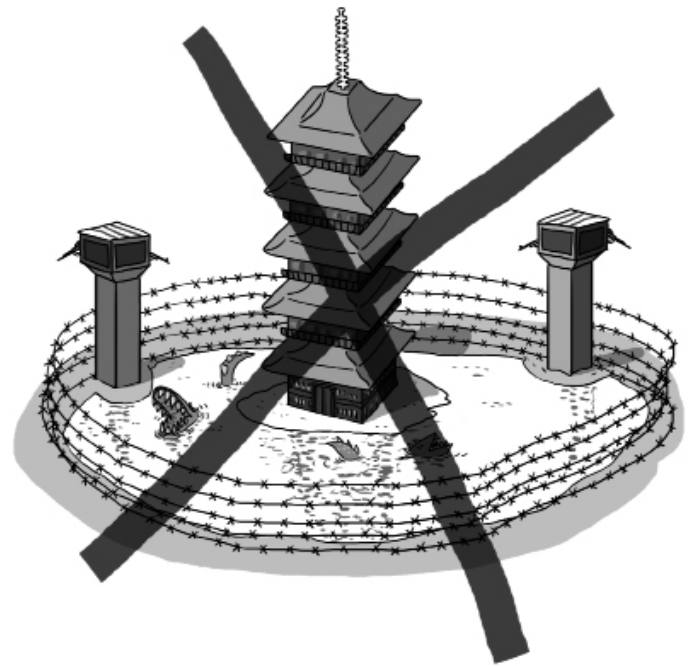

6

Take a holistic approach to security. The combination of a variety of factors will ensure effective security of the site.

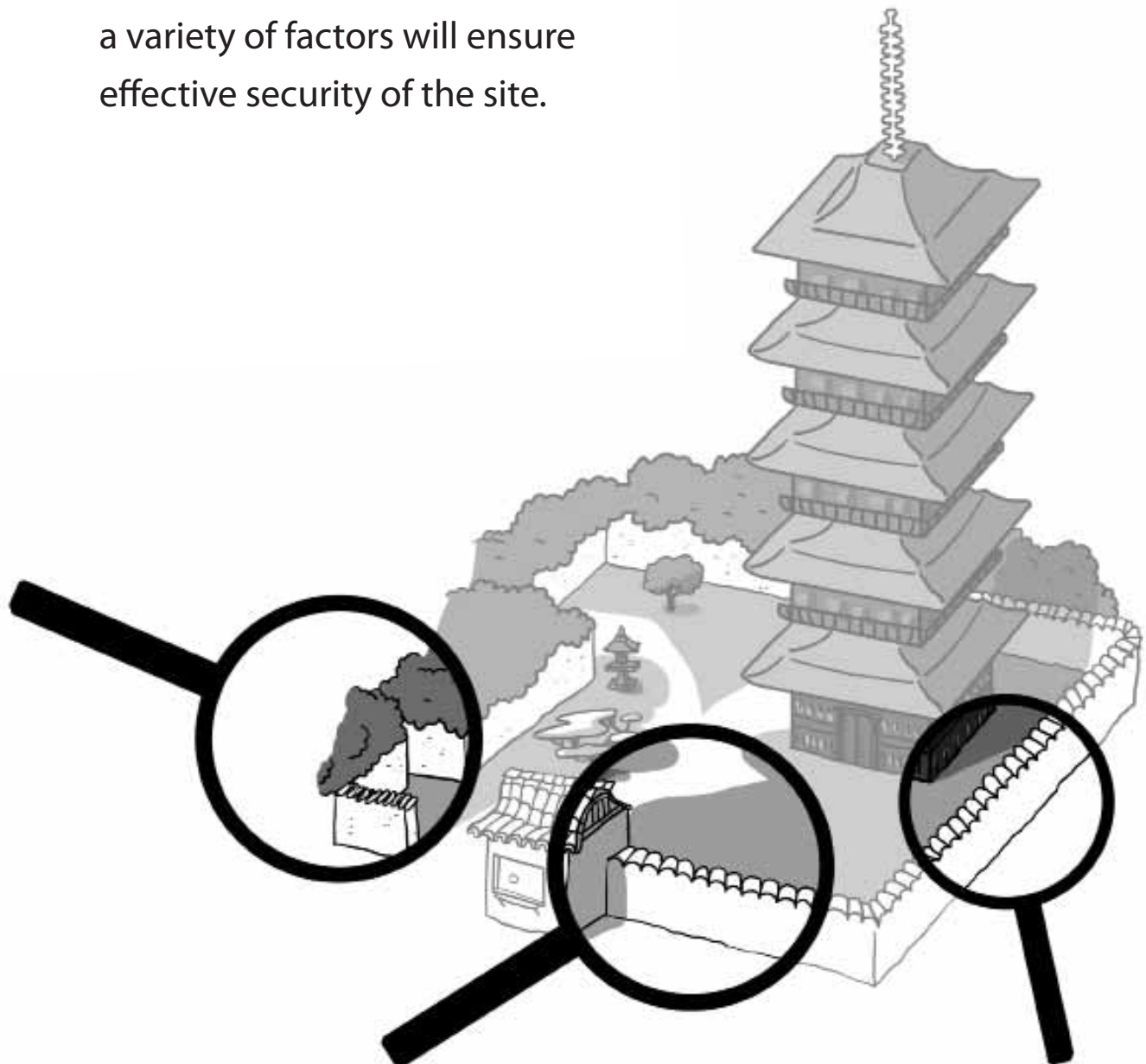

7

Remember that item security must be consistent with liturgical requirements, effective preservation, the promotion of works, building conservation requirements and public viewing.



8

Lastly, try to see the site from a thief's standpoint.

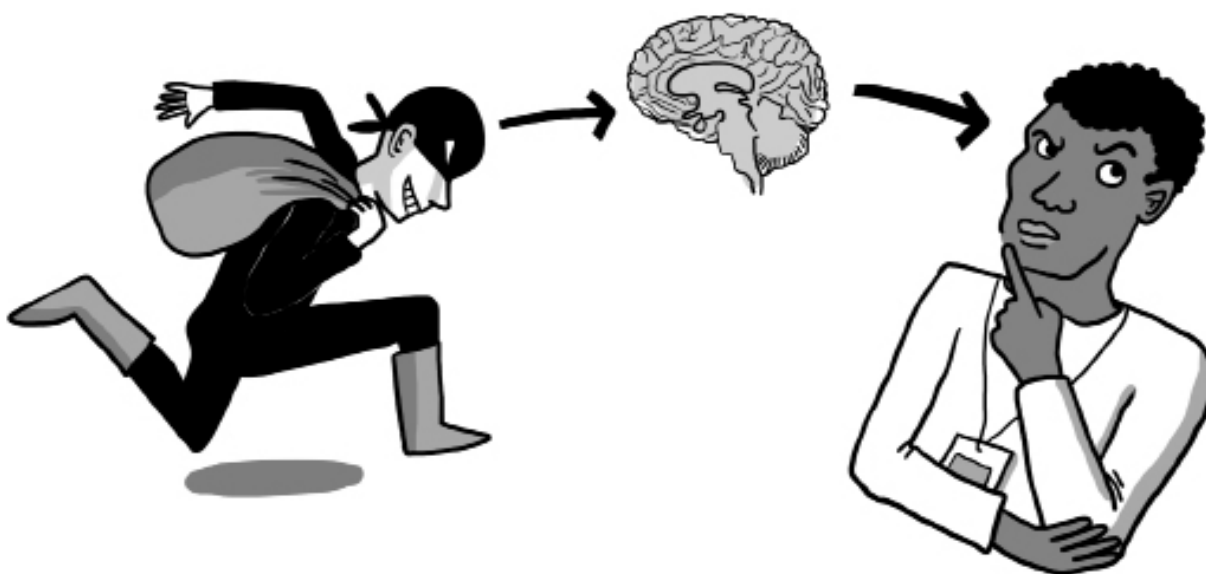

SITE MANAGEMENT MEASURES

Many of these measures are by no means spectacular and may even seem trivial.

Nevertheless they can assuredly deter or disrupt thieves and thwart any attempts to steal.

9

Make religious leaders, the population and police services aware of the heritage value of the monument's contents (through posters, conferences, leaflets or explanatory notices).



10

Call on people to be on the alert and, if need be, report anything suspicious to the local heritage official or the local police.



11

There are often very few or no people at all on sites of religious interest. Give the impression that there are many visitors to the site and that it is by no means deserted.

12

Ensure that people are on the premises (employ a caretaker or volunteers). The human presence is irreplaceable.



13

Approach visitors and greet them so that they know that they have been identified.

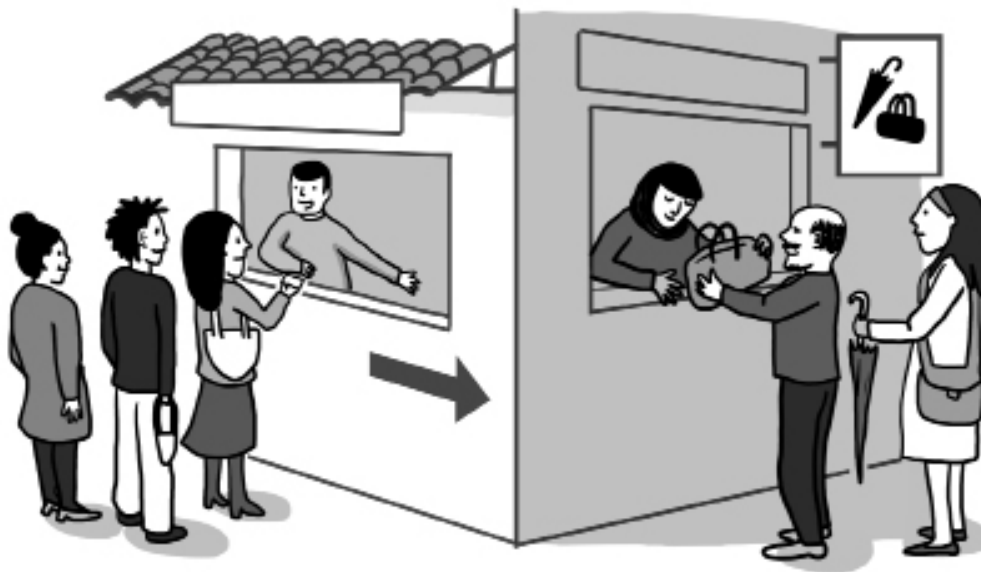

14

When circumstances allow, ensure that visitors leave large items (bags, helmets, umbrellas and so forth) at the entrance to the building.



15

Indicate prohibited behaviour by signposts: such as the use of flashes, improper clothing, eating and drinking.

16

Keep the grounds of the site in good order. Do not allow any area near the building to become overgrown or deserted.



17

Keep the inside of the building also in good order. Do not allow any disorder or accumulation of miscellaneous objects. Clean the premises regularly and grow flowering plants, if possible...



18

Give the impression that people are on the premises, perhaps by playing background music.



19

In some buildings, it may be advisable to leave the main doors wide open to let outside light and noise into the premises. The thief may then feel less comfortable to act as is more likely to be spotted.



20

Put up signposts in order to communicate with visitors (warnings and prohibitions).



21

Light up the premises surrounding the site, use motion sensor lights outside and inside or even light-timers.

22

Allow visitors to use only one of the building exits, preferably under a watchful eye.

23

Do not leave ladders, steps or tools lying around! Store them out of reach.

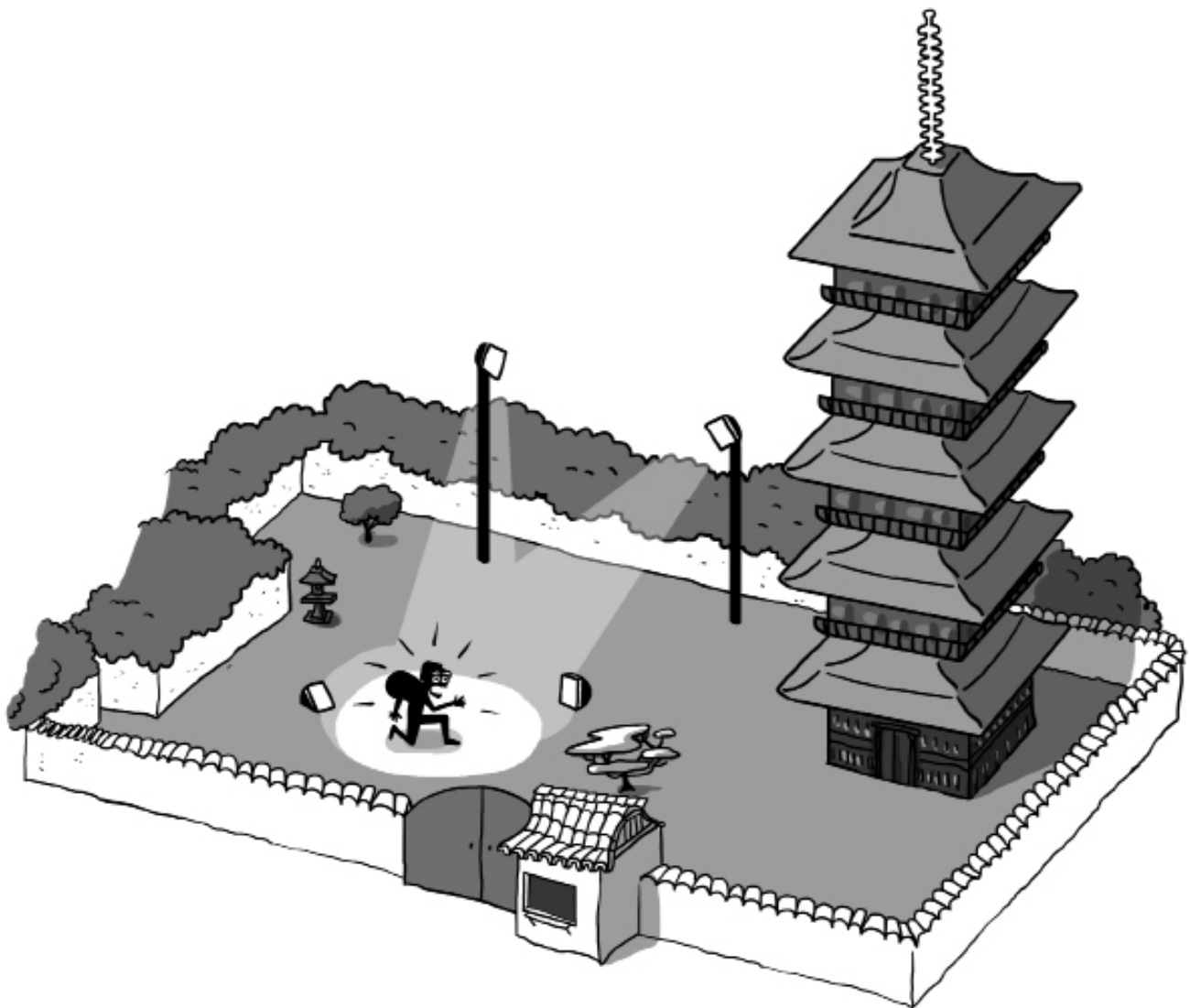

24

Ensure that items cannot be seen from outside.

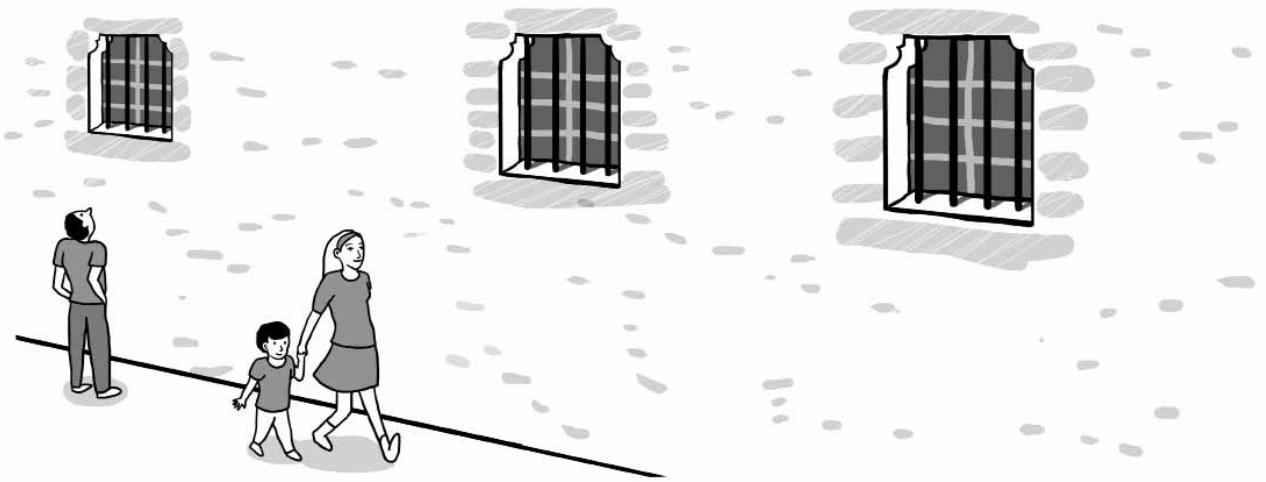

25

Do not leave small items within reach.

Keep them in a safe place.



26

Never leave an object behind a window situated at eye-level, even if it is equipped with bars. The window can be broken and the object passed through the bars, if it is small enough.

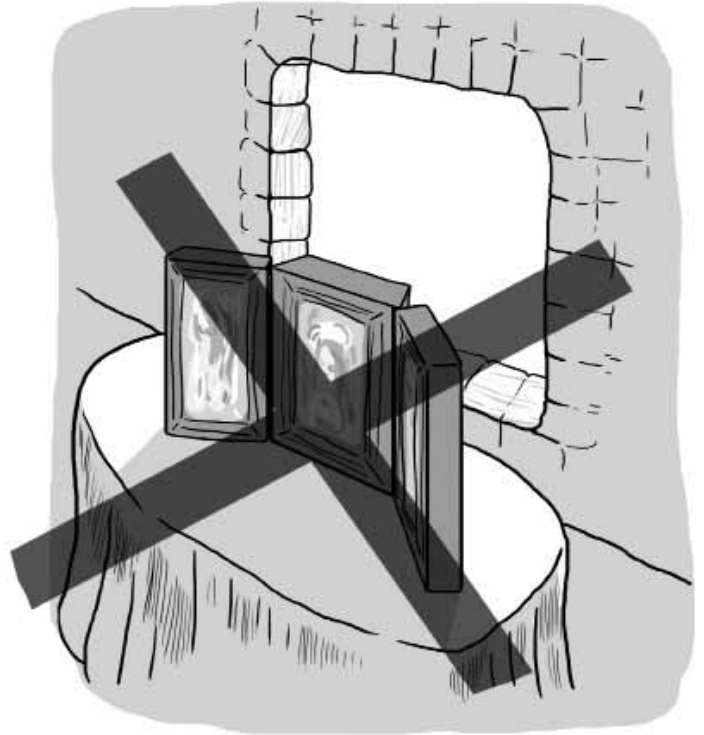

27

Lock all places in which a thief may hide (in churches, for instance, the doors to confessionals, to the galleries and to the vestry).

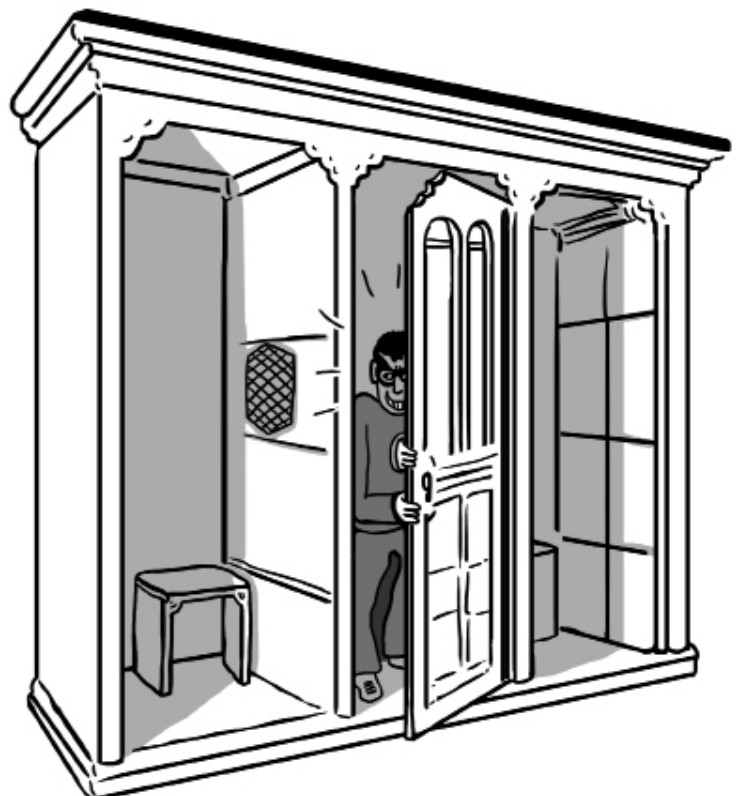



28

Use ropes and signs prohibiting admittance to specific parts of the building.

29

Manage the keys of the monument. Keep track of the number of sets and who holds them. Limit their number. Issuance of keys raises the risk of theft.



30

Do not leave keys out. Keep them in a secure place.

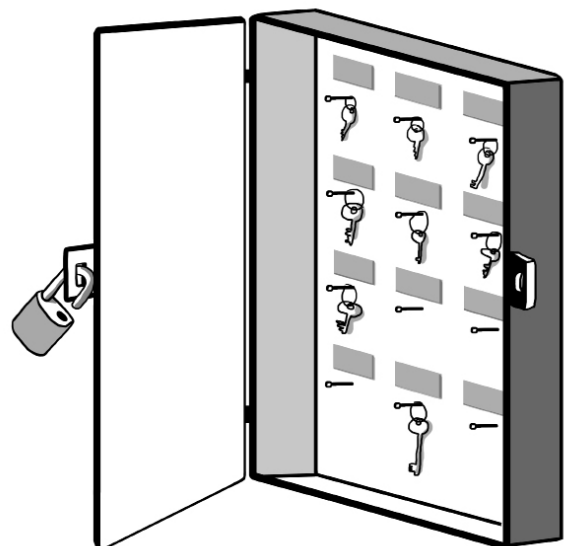

31

Introduce procedures for opening and closing the building that are consistent with security requirements. Conduct an inspection before closing time.



32

The person(s) responsible for this task must carry a whistle and torch.

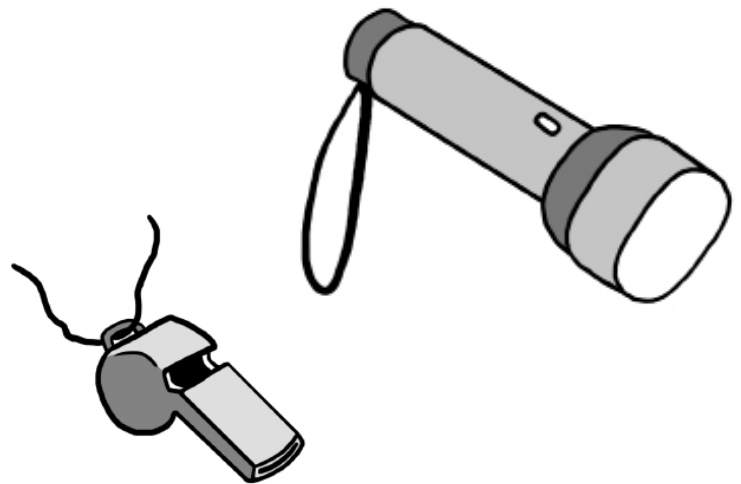

33

Consider closing the site at lunchtime, when thefts are most likely to occur.

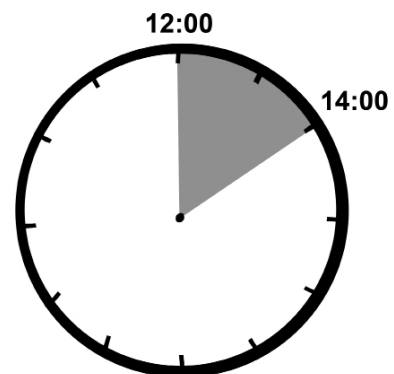

34

If there is no caretaker, public opening hours may be shortened: neither too early in the morning nor after dusk.

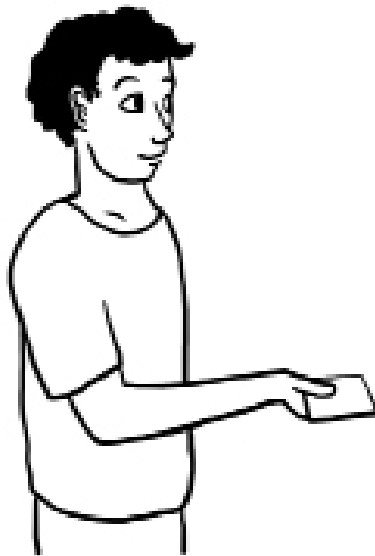

35

If someone wishes to visit the building outside opening hours, the visitor must be shown round and must never be given the key without completing prior formalities (including at least the presentation of an identity document and the prior completion of a form).



36

Never mention the market value of an item to strangers.



37

Arrange the entrance to the building by installing a gate or burglar-proof glazing so that people can look into but cannot enter the building.

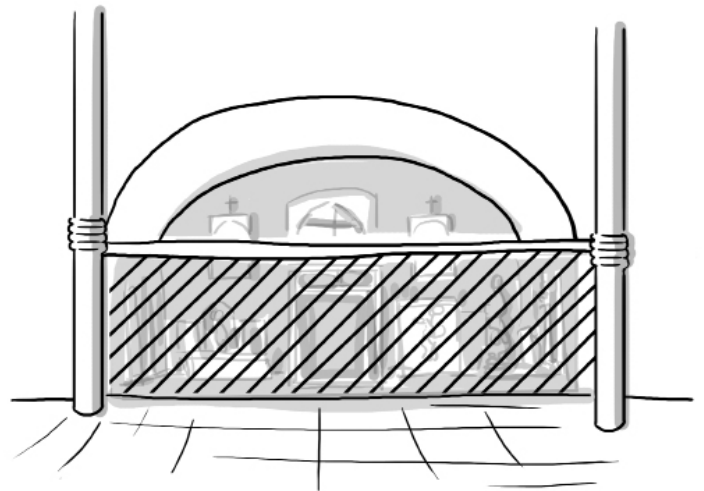

38

Be particularly careful when work is being done in the building and when scaffolding is in place.



The same applies during festive periods or major events (the New Year, sports championship finals and so on).

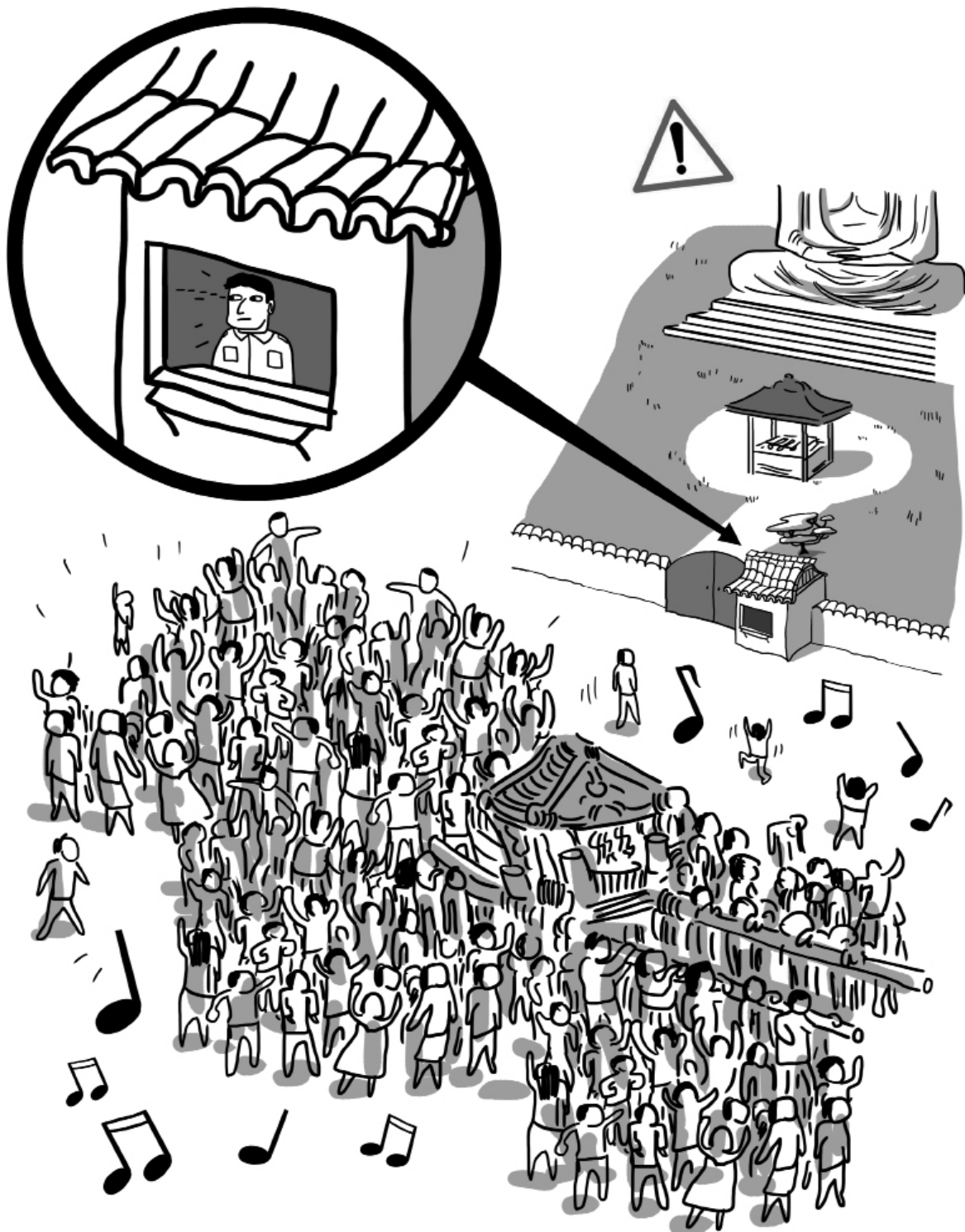

PHYSICAL PROTECTION OF THE SITE

.....

This is aimed particularly at preventing burglary at night. The measures taken should prevent break-ins and deliberate lock-ins on the premises at closing time.

40

Ensure that the fence enclosing the site is as intruder-proof as possible and protect basement windows, fanlights and skylights...

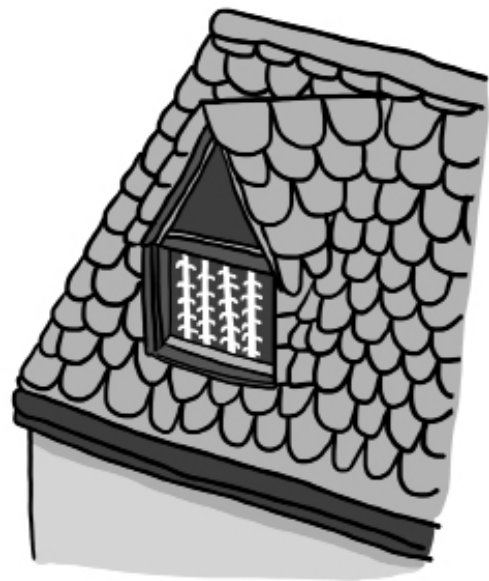

41

But bear in mind, that in most cases the thief enters and leaves through a door.



42

Ensure systematically that security devices are all made of materials of the same quality.

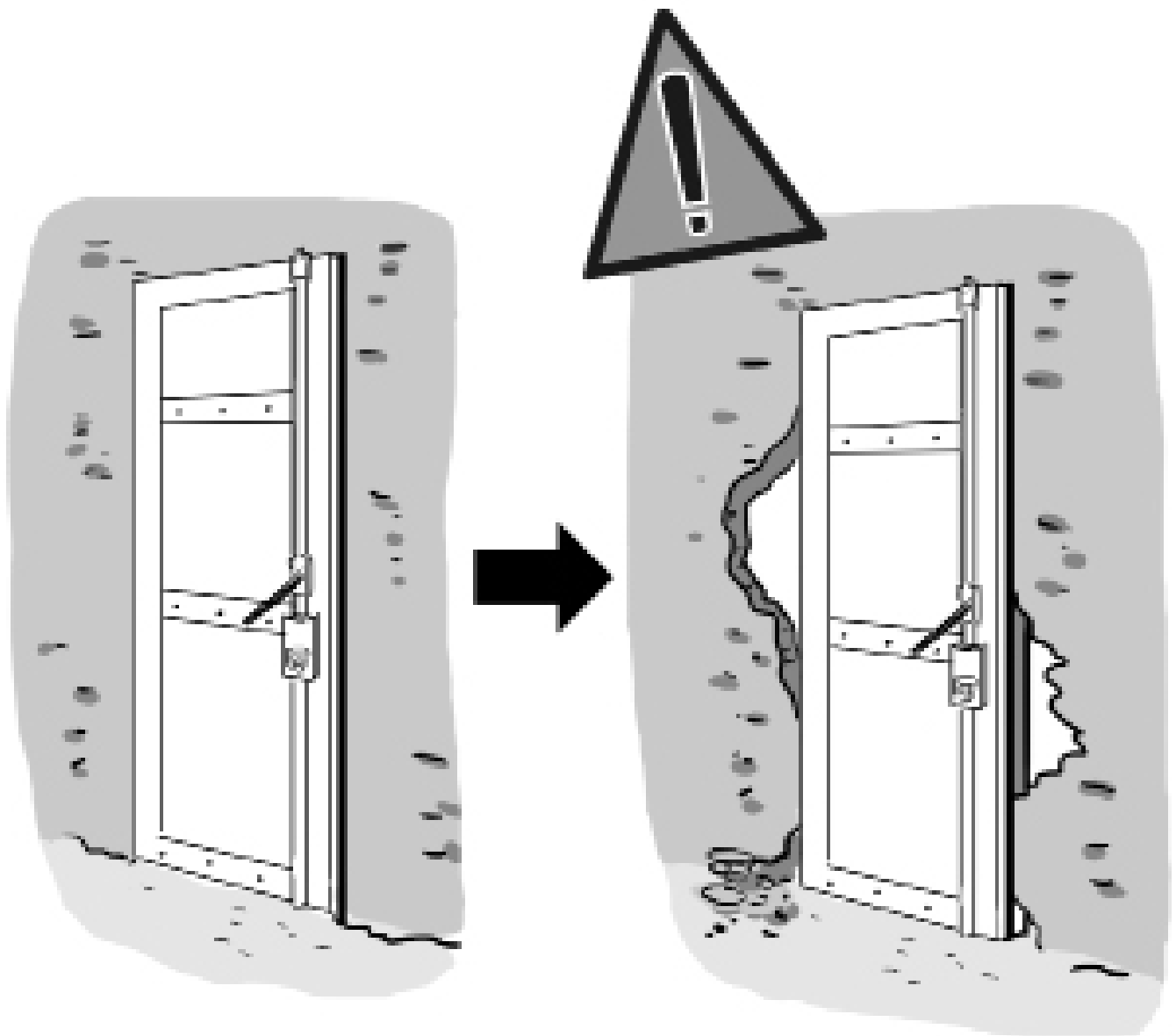

43

Choose only one main entrance that can be unlocked from outside.

44

This main entrance should be fitted with a multipoint locking system and be burglar-proof.

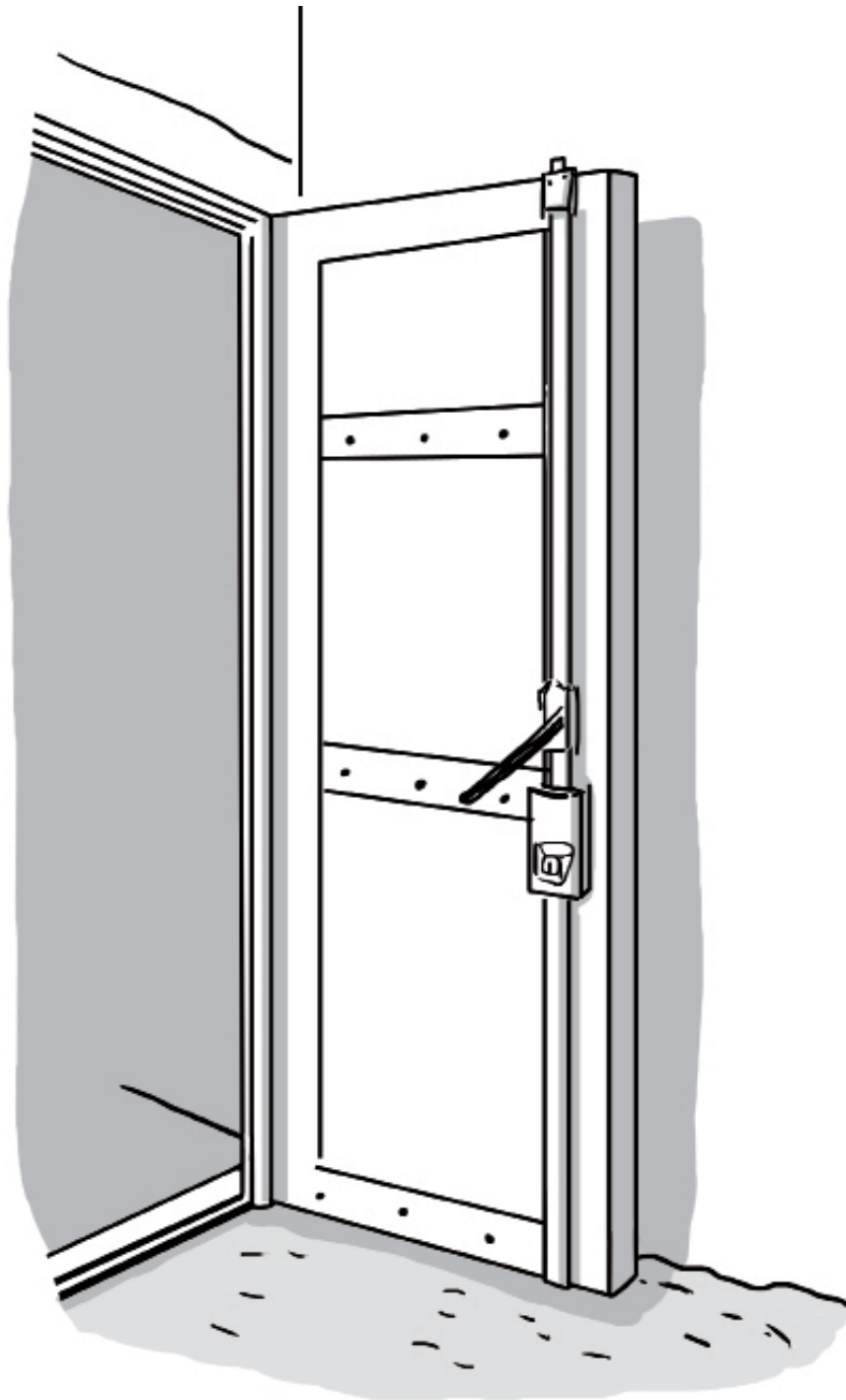

45

Protect all other secondary entrances from the inside with door security bars or iron bars secured with high-security padlocks. Avoid all external locks.

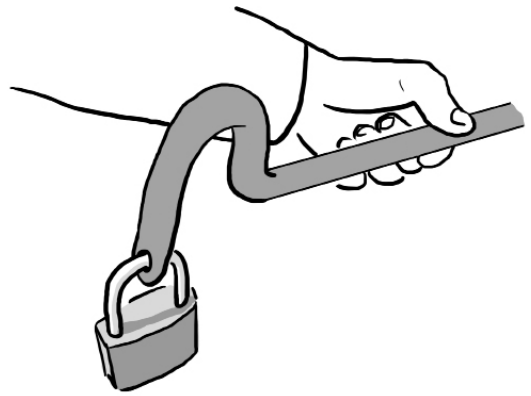

46

Inspect locking points on the floor or in the jamb regularly.

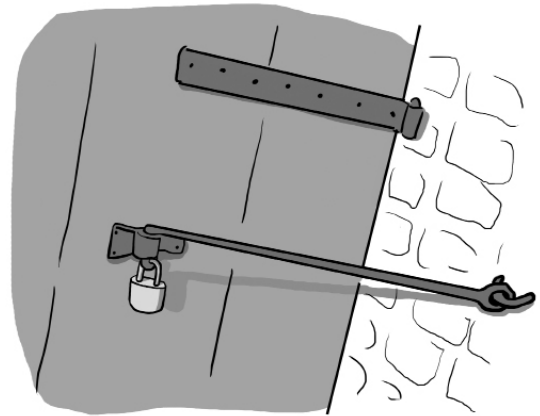

47

Protect the windows with security bars, in particular the lowest windows and those that are not immediately apparent.

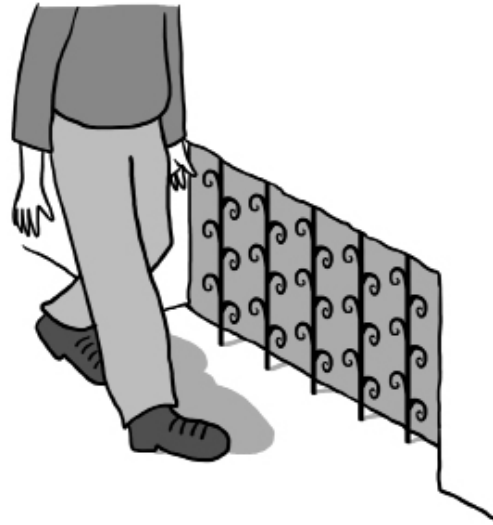

48

Ensure that the bars are solid (sufficiently thick, 14 cm apart, and a cross bar every 80 cm) and that quality anchoring mechanisms are used in the walls.

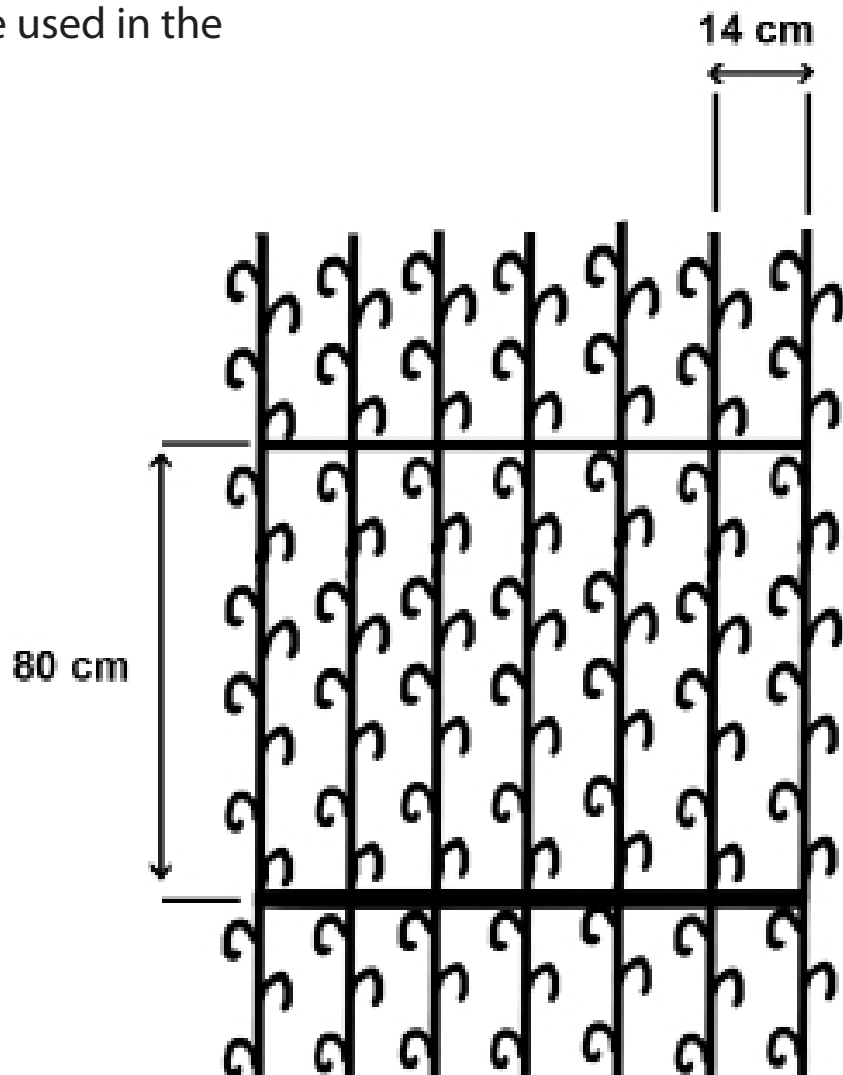

49

In any event, place special emphasis on the quality of the security products used.



50

Supplement the window security mechanism with an anti-projectile mesh or burglar-resistant glazing film.

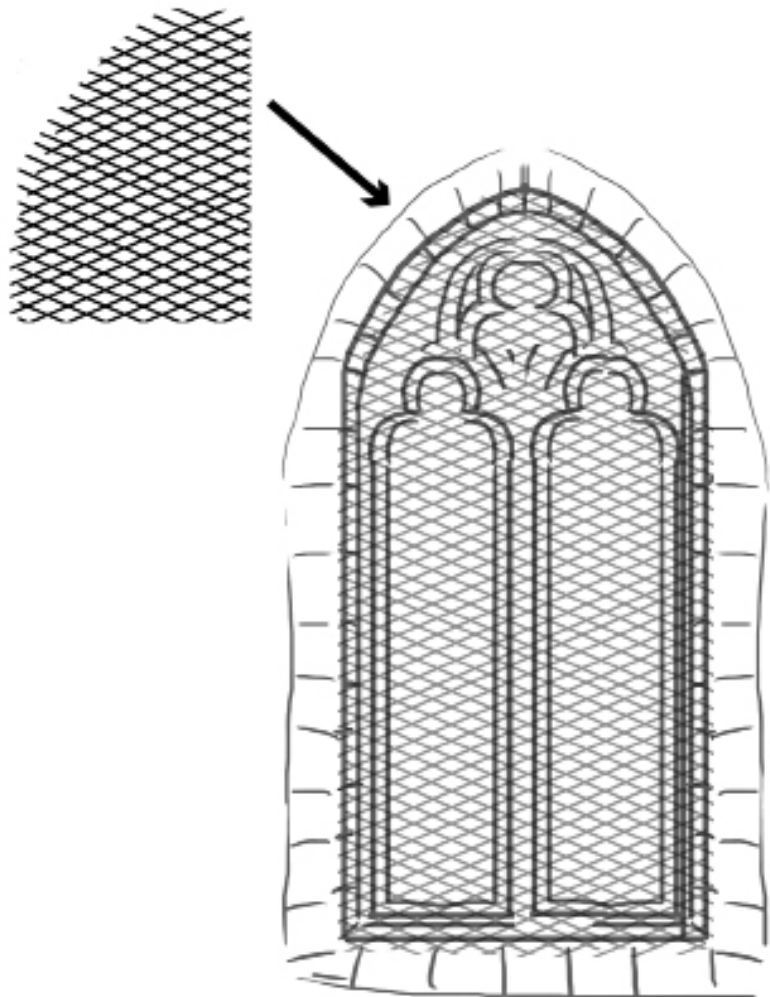

51

Use the appropriate device to lock window catches.

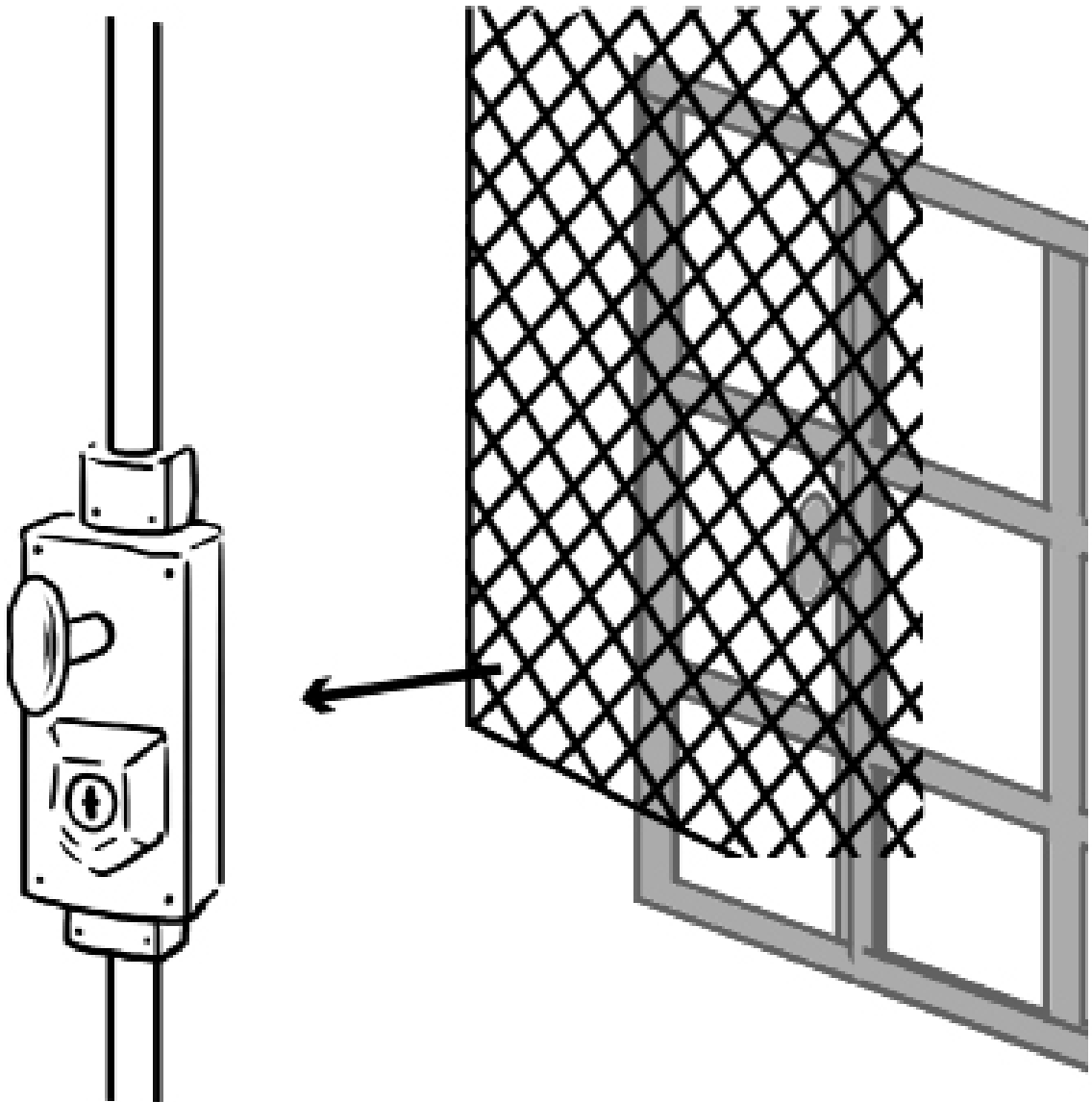

52

Grind down the screw heads of locking devices or use complex screw heads to make it more difficult for the thief to escape.

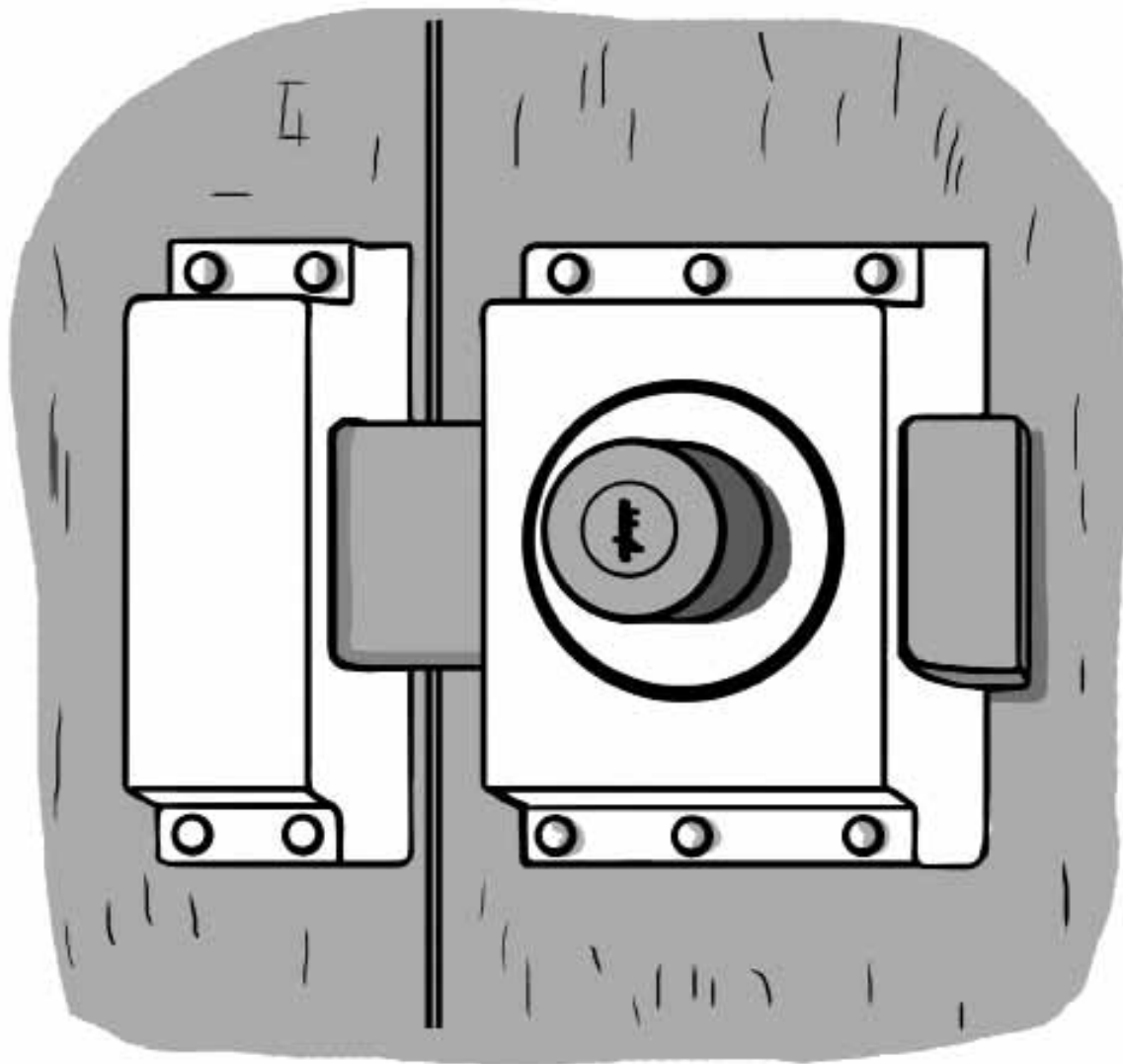

PHYSICAL PROTECTION OF ITEMS-
SIMPLE AND DRASTIC MEASURES

.....

This is another key link in the security chain.

It should be made impossible to steal an object in broad daylight.

53

Place the most vulnerable items, in particular the smallest and lightest items, out of reach and out of sight.

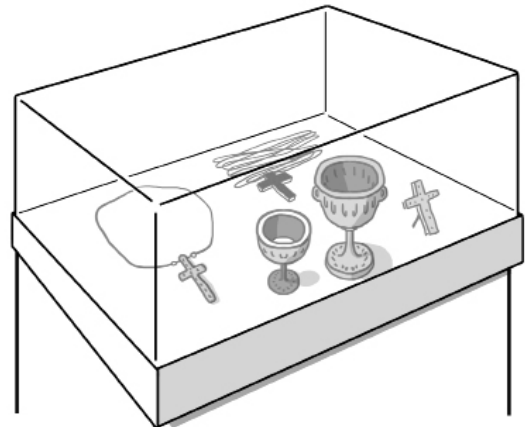

54

Store small furniture and silverware away, possibly in a safe.

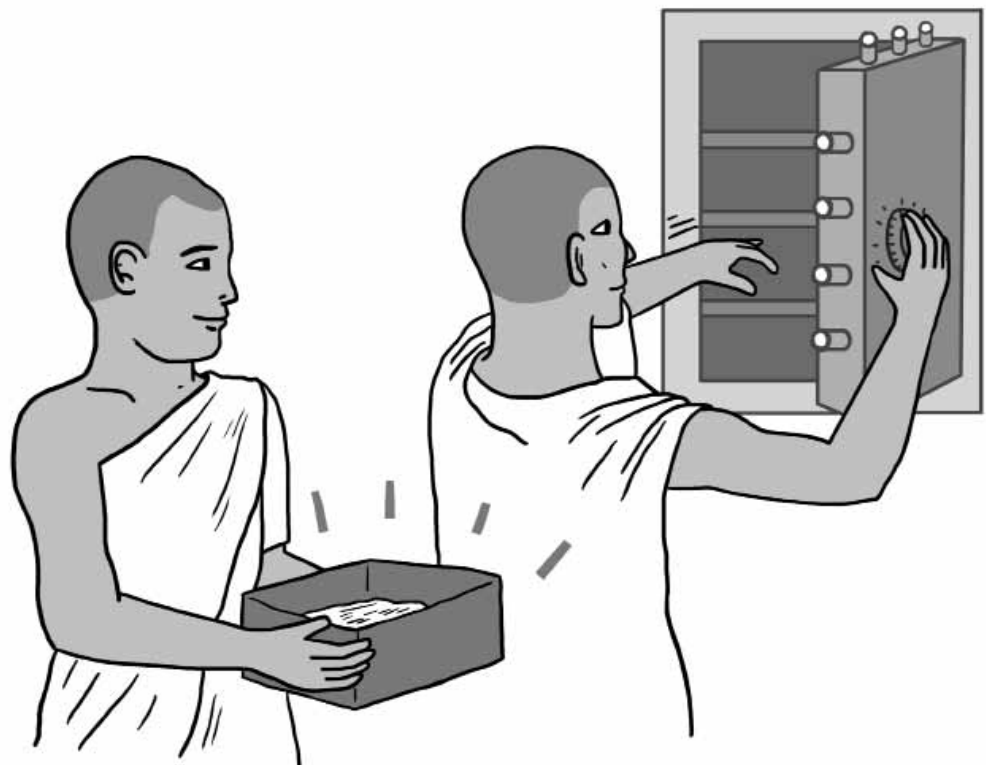

55

Place items in well-chosen areas, avoiding corners, blind spots, the half-light and proximity to an exit.

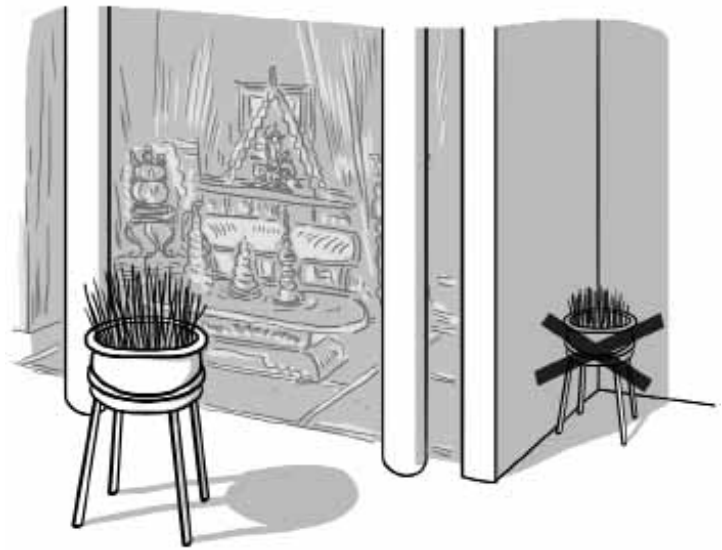

56

Exhibit items at a sufficient height to be difficult to reach.



57

Avoid displaying works over tables or benches which can be used as steps.



58

Anchor statues (under the supervision of a restorer) to their plinth or frame.

A variety of methods can be used.

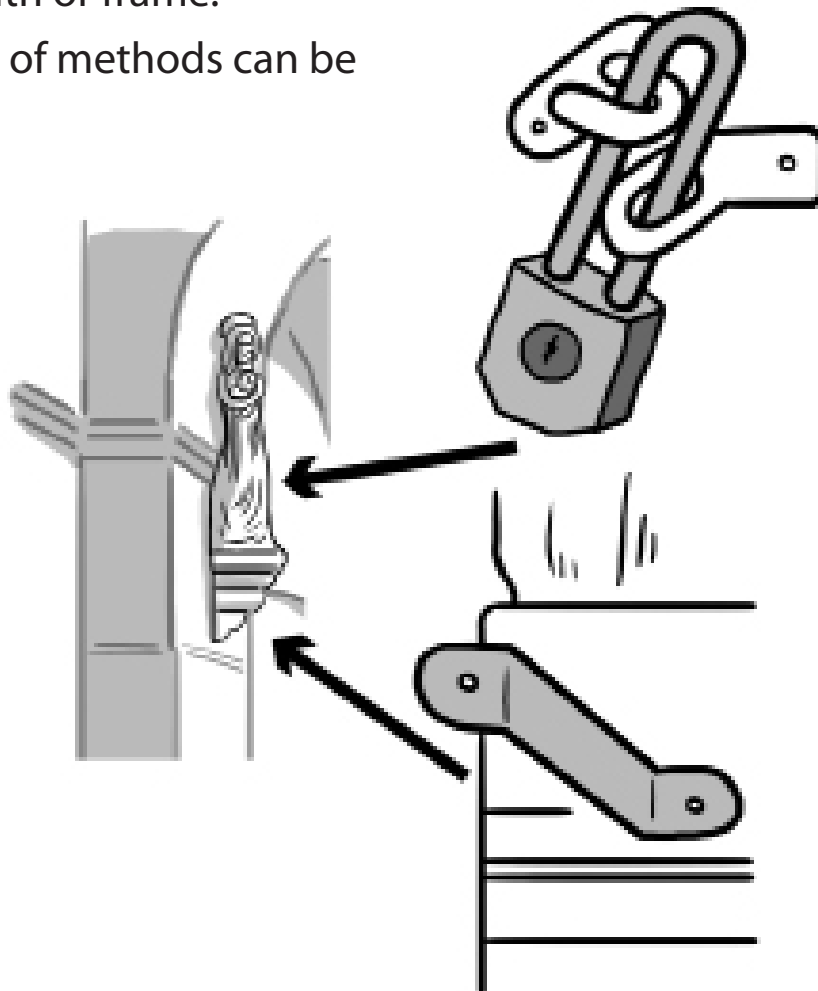

59

Use braided steel wire or any other means to secure all other small items in the building together.



60

Hang paintings with secure attachments. Rather than hooks and mere string, use suitable brackets.

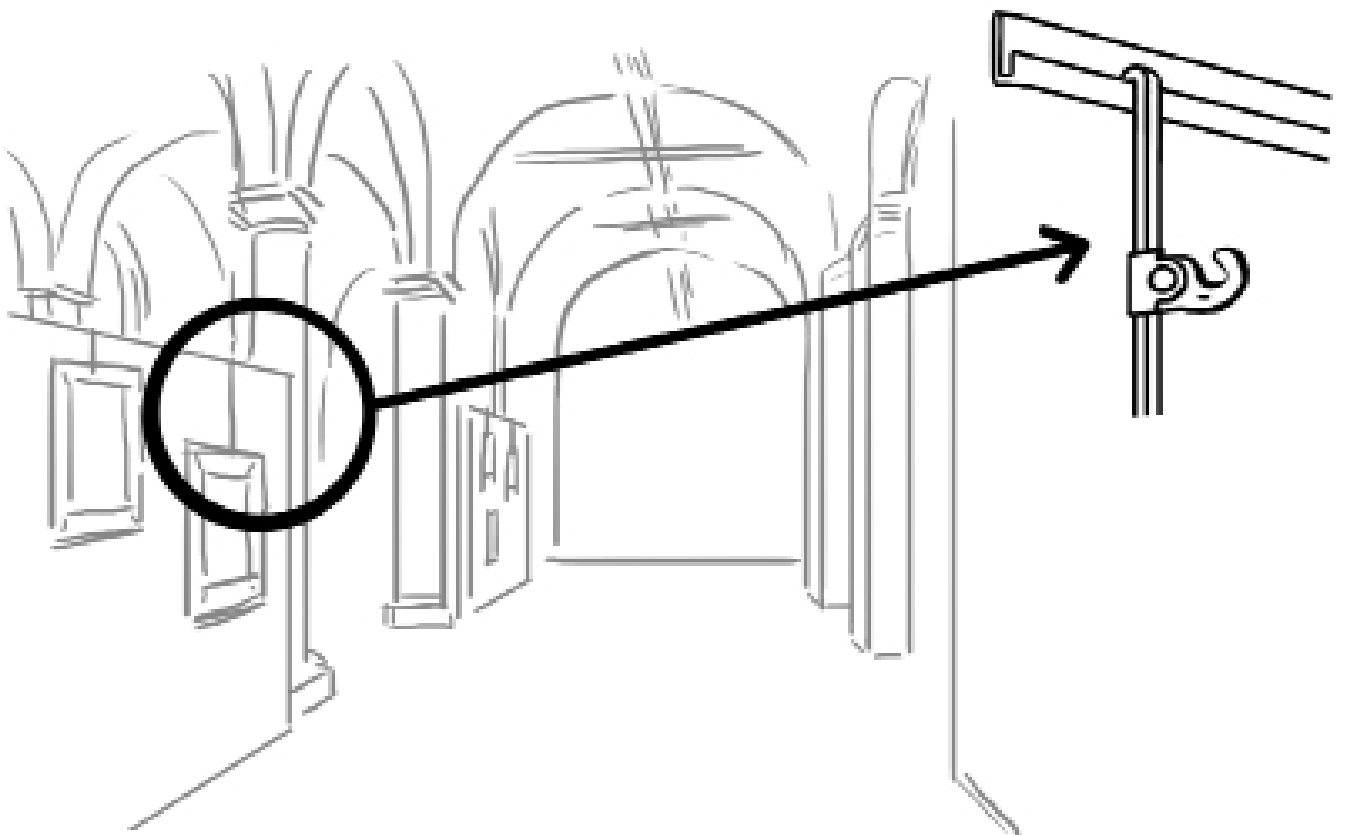

61

In churches, use stainless steel rods to secure the altarpieces.

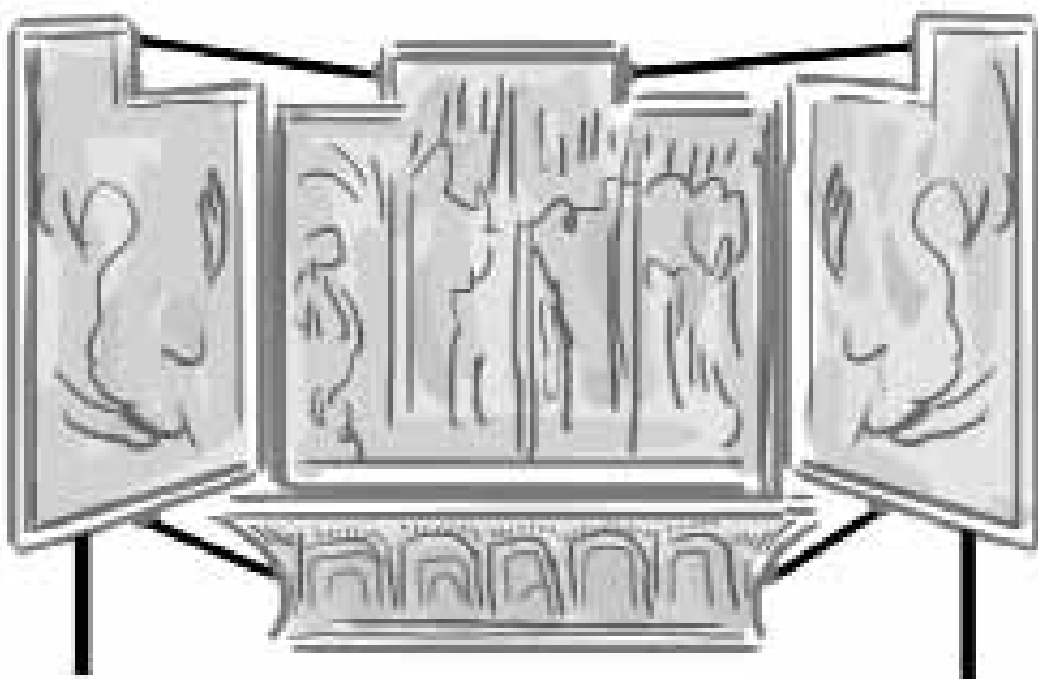

62

Consider placing valuable or fragile items in secure cabinets ...

63

... or in existing structural niches and recesses.

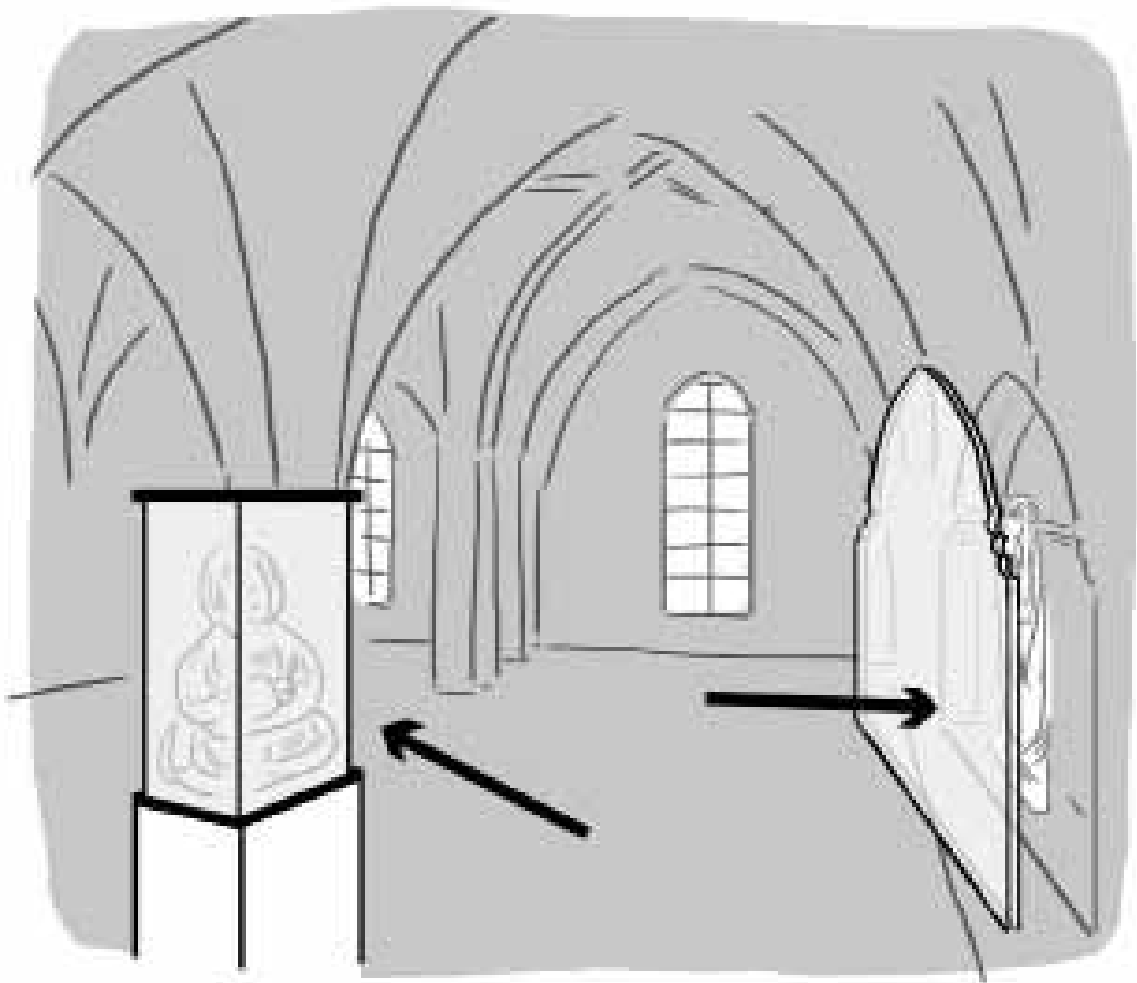

64

Consider using a specific part of the building as a sanctuary for displaying important items and creating “treasuries”.



65

At closing time, check that all works are in place and have not been touched or moved.



66

To prevent fires, remove all potential fire hazards. Also check and replace electrical fixtures if they are clearly in a state of disrepair.

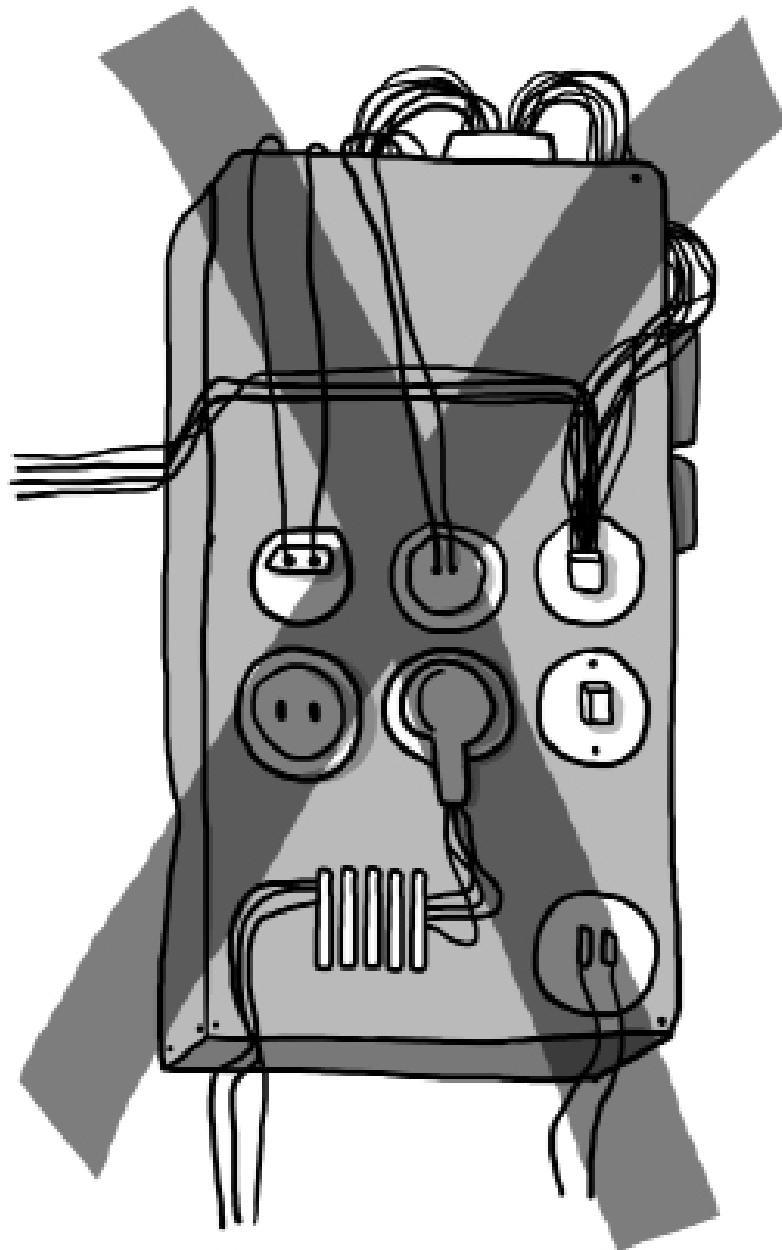

COMPLIMENTARY ELECTRONIC PROTECTION OF THE SITE AND ITS ITEMS

.....

This is clearly a complementary measure, as reliance cannot be placed on an alarm alone.

Experience shows that such protection requires an effective prior assessment and should be easy to use.

67

Place all the doors in the monument under electronic surveillance (opening sensors).

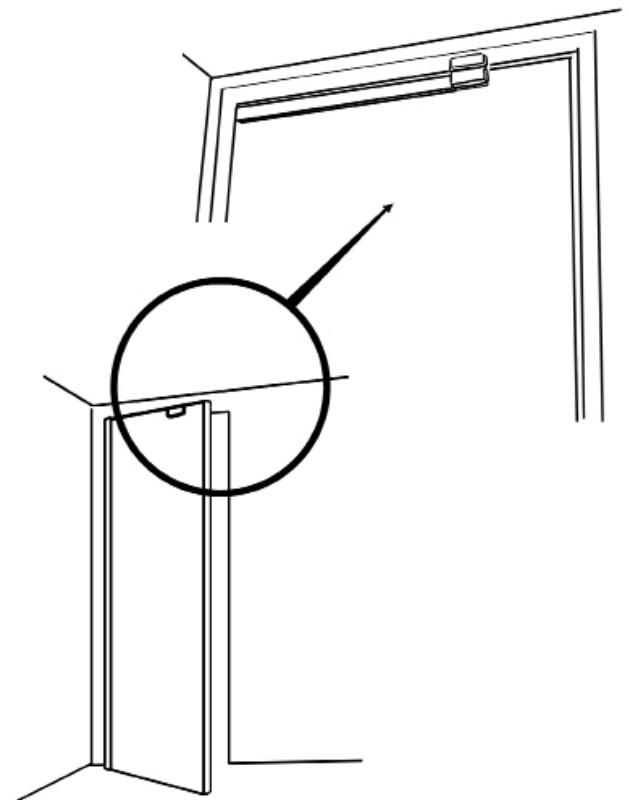

68

Similarly protect windows (special breaking-glass detectors).

69

Install alarms, in particular bi-technology (infrared and microwave) volumetric detectors, in compulsory indoor passages.

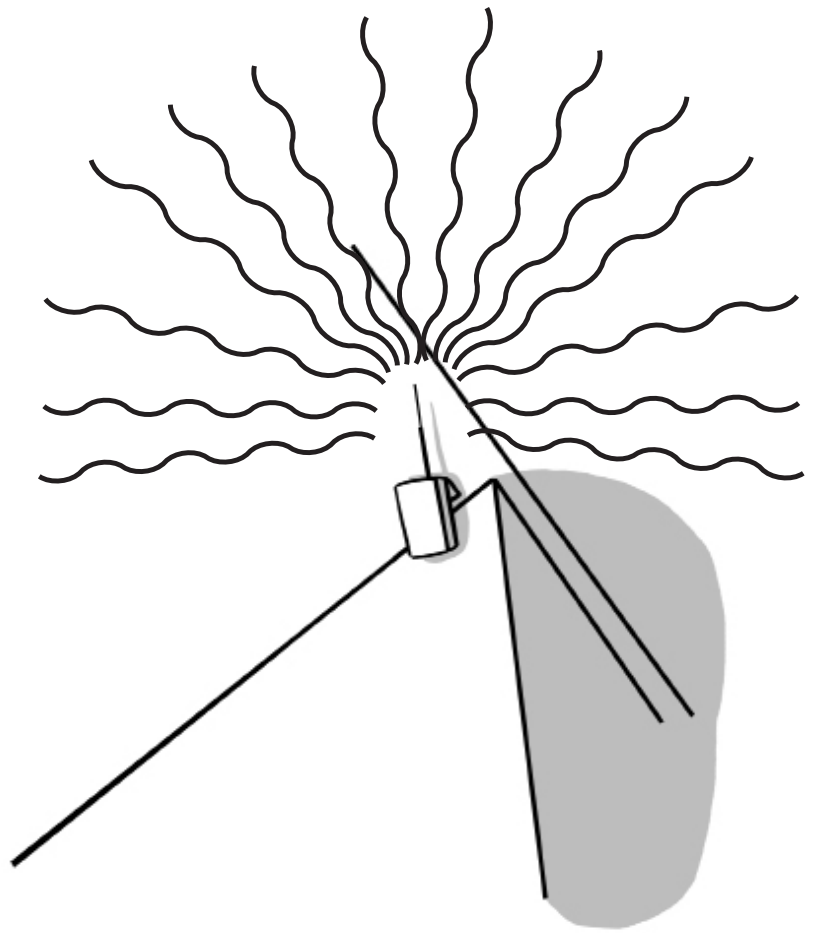

70

Infrared barriers can be used to cordon off a specific area.

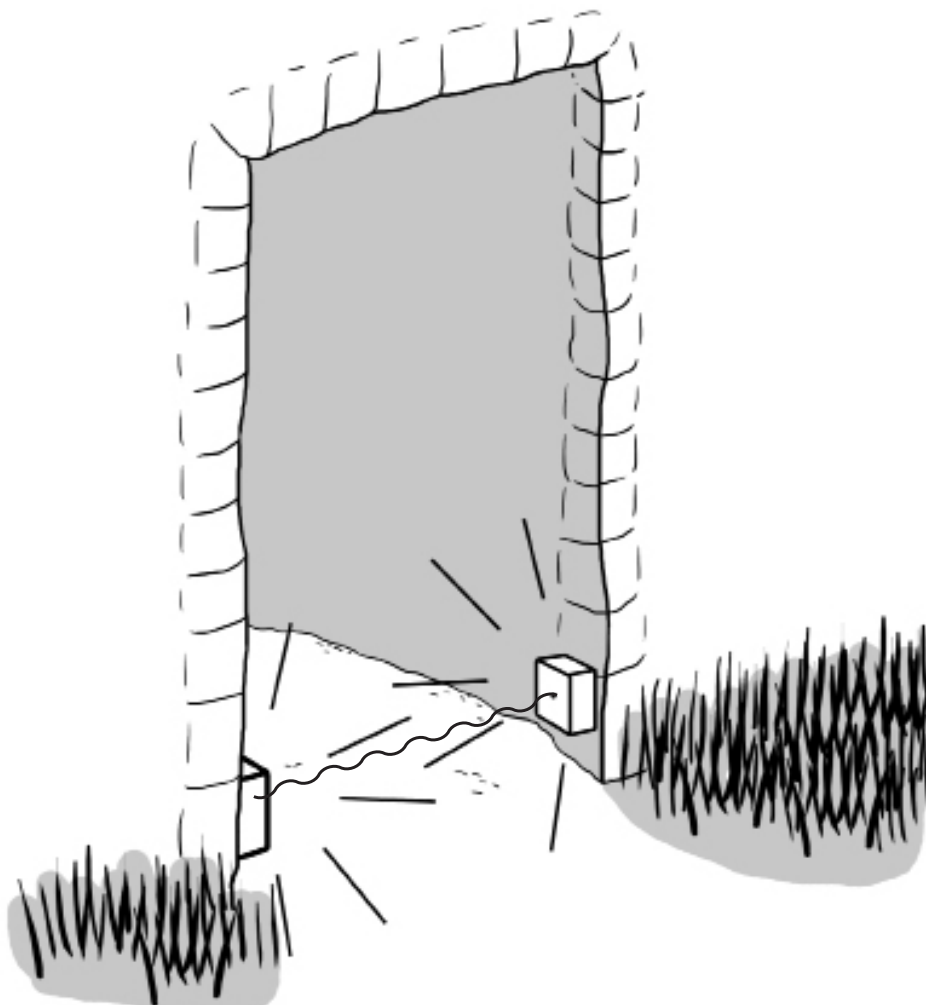

71

Protect works individually through selective electronic detection.

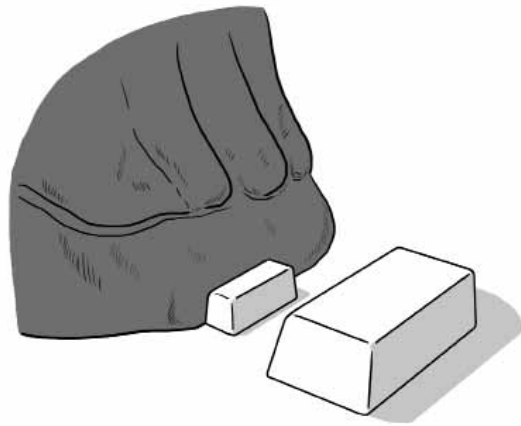

72

Reflect on the need to install devices compatible with the use of the building. Owing to poor system management, alarms may be triggered inadvertently, leading either to system deactivation or lower vigilance.

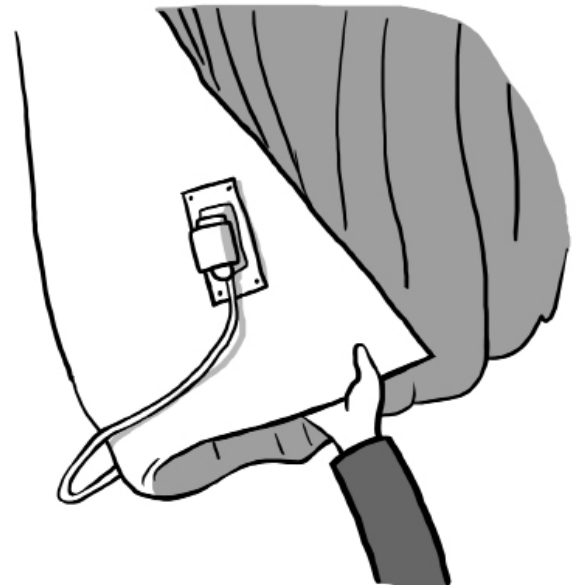

73

Be careful to use quality hardware. Give priority to certified products.

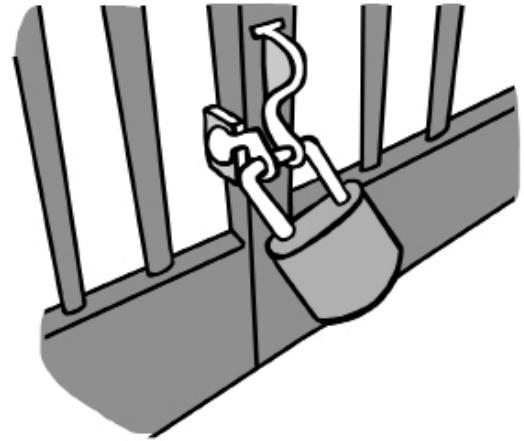

74

Be careful in installing hardware. Sirens, for instance, should be placed sufficiently high and out of reach so that they cannot be disabled.

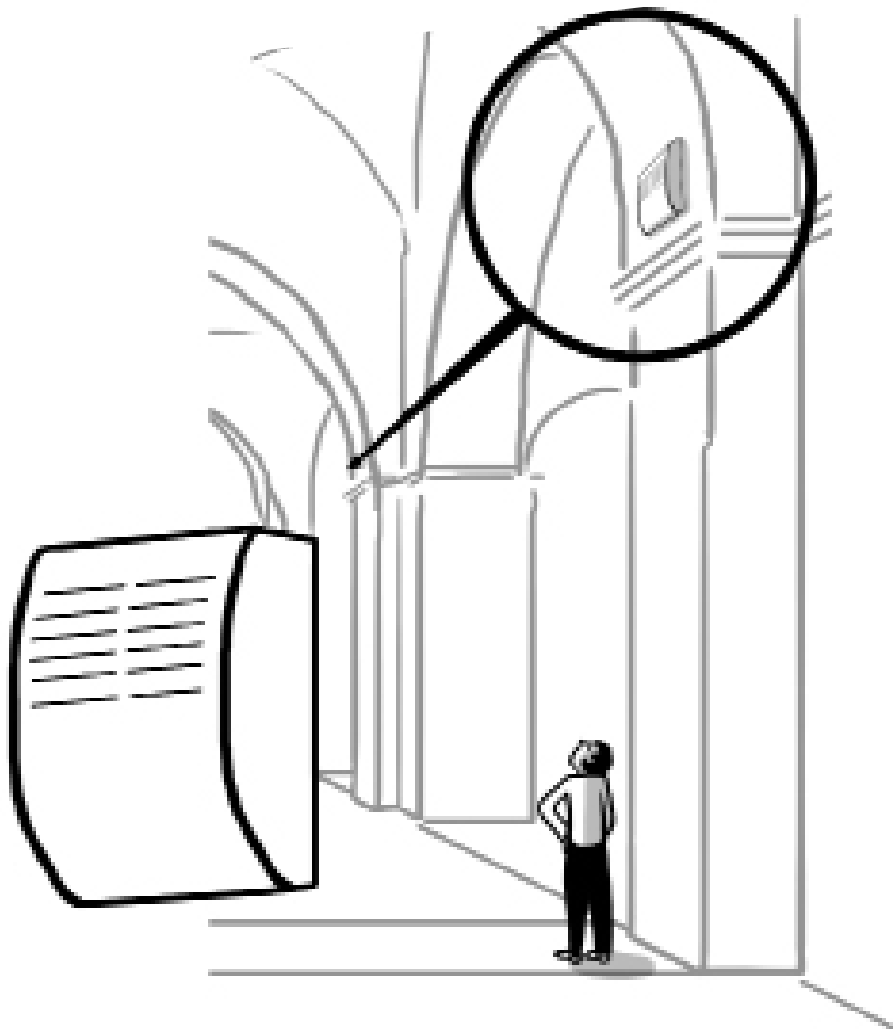
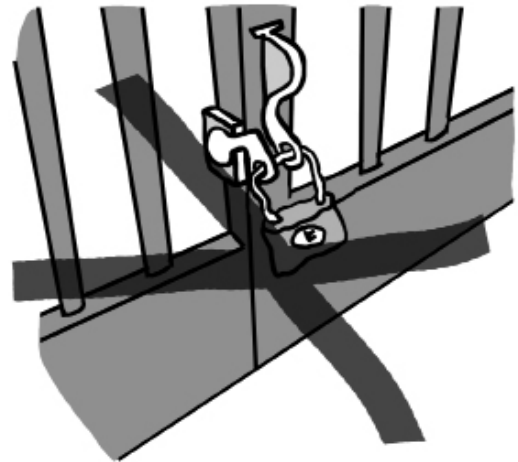

75

Choose light-activated
“flashing” sirens.



76

Preferably have alarms
connected directly to the
nearest police station.

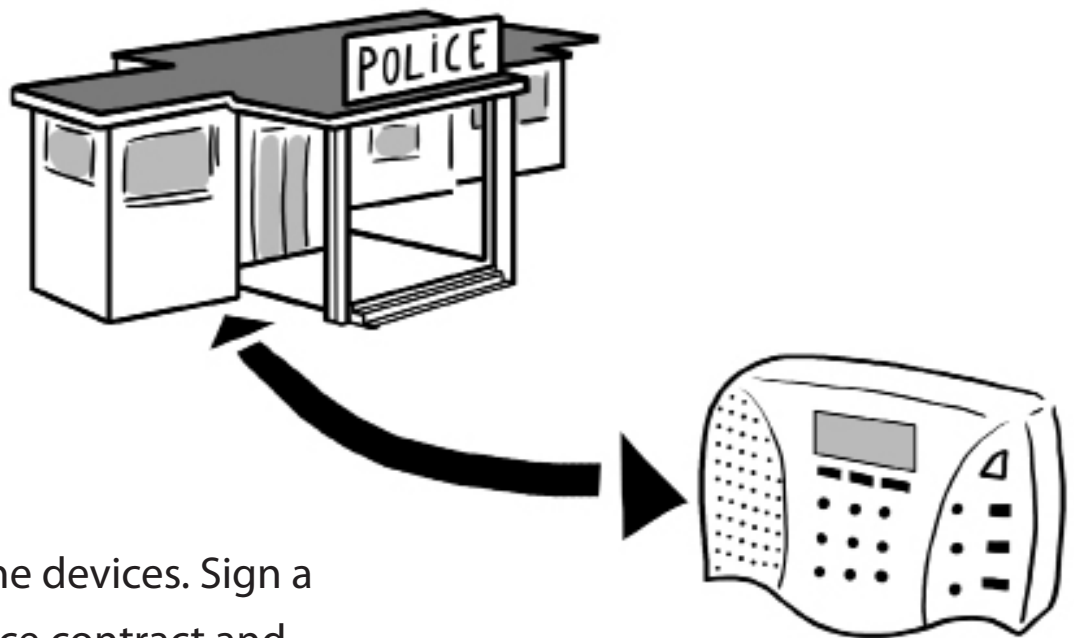

77

Maintain the devices. Sign a
maintenance contract and
conduct tests regularly.

VIDEO SURVEILLANCE

.....

Beware! Video surveillance is no panacea.

This must be regarded as a complementary measure only.

Experience shows that it can have the highly undesirable effect of suggesting that “everything is under control”, thus resulting in failure to use basic protection measures and lower vigilance.

78

Assess needs and ensure that the project is worthwhile.

79

If video recordings are to facilitate investigations, excellent quality hardware must be installed and optimum conditions created.

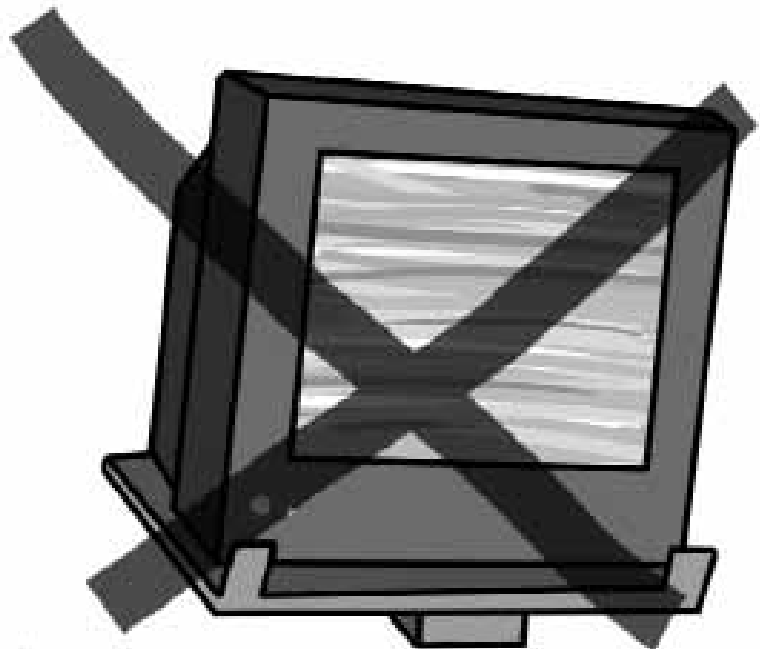

80

Dummy cameras, easily purchased on the internet at a very low cost, may be used as a deterrent. Warning notices may also be placed next to the cameras.

81

Do not allow visitors to view the surveillance screens.



WHAT TO DO
IN THE EVENT OF THEFT?

.....

82

Secure the premises:
protect the site and take
precautionary steps to
facilitate the investigation. Take
photographs of the premises.



83

Report the matter to the police
authorities as soon as possible,
providing a description and
photographs of the stolen
items.



84

Report the theft to the heritage authorities.



85

Do not hesitate to publicize the theft.



86

Remember if no inventory or photographs are available, there is little likelihood of recovering a stolen item (if recovered, items may be returned on the sole evidential condition of a record*).

* UNESCO's 1970 Convention

CONCLUSION

.....

Prioritize site management measures, encourage human presence and never neglect physical protection.

Lastly, remember that everyone has a role in the protection of living heritage sites!

Further information on theft and trafficking in cultural property is available on the websites of the following organizations:

UNESCO:

www.unesco.org

ICOM:

www.icom.museum

INTERPOL:

www.interpol.int

Notes



9 789230 010744