



United Nations  
Educational, Scientific and  
Cultural Organization



# TOWARDS RESILIENT NON-ENGINEERED CONSTRUCTION

GUIDE FOR  
RISK-INFORMED POLICY MAKING

---

**TOWARDS RESILIENT  
NON-ENGINEERED CONSTRUCTION**

GUIDE FOR  
RISK-INFORMED POLICY MAKING

---

Published by the United Nations Educational, Scientific and Cultural Organization (UNESCO),  
7, place de Fontenoy, 75352 Paris 07 SP, France,

© UNESCO 2016

ISBN UNESCO 978-92-31-001741



This publication is available in Open Access under the Attribution-ShareAlike 3.0 IGO (CC-BY-SA 3.0 IGO) license (<http://creativecommons.org/licenses/by-sa/3.0/igo/>). By using the content of this publication, the users accept to be bound by the terms of use of the UNESCO Open Access Repository (<http://www.unesco.org/open-access/terms-use-ccbysa-en>).

The designations employed and the presentation of material throughout this publication do not imply the expression of any opinion whatsoever on the part of UNESCO concerning the legal status of any country, territory, city or area or of its authorities, or concerning the delimitation of its frontiers or boundaries.

The ideas and opinions expressed in this publication are those of the authors; they are not necessarily those of UNESCO and do not commit the Organization.

**Authors:**

Andrew Charleson, Atsuko Nonoguchi, Ayako Maeshima, Carlos Villacis, Chikahiro Minowa, Gholamreza Zamani, Hiroshi Imai, Kenji Okazaki, Kentaro Yamaguchi, Rajib Shaw, Seiichiro Fukushima, Shigenori Kita, Shinobu Saito, Shizuko Matsuzaki, Shoichi Ando, Soichiro Yasukawa, Tatsuo Narafu, Toshiaki Yokoi, Toshikazu Hanazato, Yuji Ishiyama.

**Editor:** Tatsuo Narafu

**Editorial contribution:** Kazuyoshi Nishijima, Keiko Sakoda

Front cover: Nordroden, shutterstock.com

Cover and graphic design:

Sourible (UNESCO/MSS/CLD)

*Printed in France*

---

## FOREWORD

---

Disasters are increasing in terms of frequency, complexity, scope and destructive capacity. Recent years have witnessed devastating disasters from earthquakes, tsunamis, floods and wildfires. Earthquake disasters are characterized by high mortality compared with other disasters and most of them are caused by collapse of non-engineered houses.

The 2005 United Nations World Conference on Disaster Reduction called for improving the safety of buildings as a priority for global disaster reduction efforts, including through a “building disaster reduction network.” On this basis, the International Platform for Reducing of Earthquake Disaster (IPRED) was launched at UNESCO in 2008, including representatives of major earthquake prone countries.

The International Platform seeks to identify both gaps and priorities by sharing of knowledge and experience in the field of seismology and earthquake engineering. It works also to heighten political will and raise public awareness, in order to better prepare against earthquakes and foster a new culture of safety.

The Sendai Framework for disaster risk reduction was agreed at the 3rd UN World Conference on Disaster Risk Reduction in March 2015. The Sendai Framework put emphasis on pre-disaster action rather than remaining content with post-disaster reaction. At the same time the Framework has recognized the importance of taking into account the broader cultural context in which disaster risk reduction strategies and plans are developed, if these are to be effective and sustainable.

In line with these streams, we have to seek novel approaches matched with their cultural contexts for non-engineered construction. Non-engineered buildings are built with little or no intervention by engineers and contain unique social and economic issues to improve their resilience. Effective approaches for engineered-construction to enhance safety do not apply well non-engineered construction.

UNESCO already published technical guidelines entitled “GUIDELINES FOR EARTHQUAKE RESISTANT NON- ENGINEERED CONSTRUCTION” in August 2014. These technical guidelines covered those which are spontaneously and informally constructed in various countries without any or little intervention by qualified architects and engineers in their assign.

This new publication aims at policy makers and leading engineers for formulating necessary policies and technical training for securing safety on non-engineered construction. The publication includes information and case studies as well as an

overview of gaps in this subject, overview/analysis of damage of the construction, overview of engineering/social/academic approaches, dissemination measures of technical guidelines and good practices to support policy makers and leading engineers. The publication will also have a chapter that will address the significance of gender issues in non-engineered construction.



**Flavia Schlegel**

Assistant Director- General of UNESCO

October 2016

# Table of content

Foreword	iii
----------	-----

<b>Guide for readers</b> - Introduction	1
---	---

<b>Chapter 1</b> - Perspective for Safer Non-Engineered Construction	3
--	---

1.0 Contents and Outline of Chapter 1 .....	3
1.1 Overview of Safer Non-Engineered Houses: Items to be Covered and Importance of Integrated Approach.....	4
1.2 Significance of integration of a Gender Perspective into Housing Issues.....	18
1.3 Other Aspects of Non-Engineered Buildings: Cultural and Historical Value .....	26

<b>Chapter 2</b> - Earthquake Risks and Perceptions by People	30
---	----

2.0 Contents and Outline of Chapter 2 .....	30
2.1 Understanding Seismic Risks .....	30
2.2 Risk Assessment Approaches for Countries with Limited Data .....	43
2.3 Public Perception of Seismic Risks.....	56

<b>Chapter 3</b> - Characteristics of Non-Engineered Construction	65
---	----

3.0 Contents and Outline of Chapter 3 .....	65
3.1 Reports on Damages to Non-Engineered Constructions .....	65
3.2 Construction Practice of Non-Engineered Constructions .....	76

<b>Chapter 4</b> - Technical approaches for Structural Improvement of Non-Engineered Construction	84
---	----

4.0 Contents and Outline of Chapter 4 .....	84
4.1 Understanding Structural Behavior of Non-Engineered Construction .....	85
4.2 Possible Structural Improvement Measures .....	91

<b>Chapter 5 - Dissemination of Technologies</b>	<b>99</b>
5.0 Contents and Outline of Chapter 5 .....	99
5.1 Several Approaches for Dissemination .....	100
5.2 Technical Guidelines .....	116
5.3 Formal Guidelines on Masonry .....	122
5.4 Official Guidelines for Non-Engineered Construction .....	129
<b>Chapter 6 - Towards Resilient Non-Engineered Construction</b>	<b>137</b>
6.1 Introduction .....	137
6.2 Necessity of Support and a Collaborative Platform .....	138
6.3 Environment for Sustainable Development .....	139
6.4 Steps for Safer Non-Engineered Houses .....	140
<b>Appendix - Project Examples</b>	<b>142</b>
A.0. Contents and Outline of Appendix .....	142
A.1. Capacity Building Programs .....	142
A.2. Technical Assistance by Development Partners.....	148
A.3. Leveraging Academic Knowledge and Research Capacity.....	158

## List of Figures

Figure 1.1.1 Comparison of Non-engineered and Engineered Houses	6	Figure 1.1.13 A district government office in the Special Province of Yogyakarta, Indonesia, dedicated to providing consultation for housing reconstruction (above), and a JICA capacity development program for local government officials (below)	15
Figure 1.1.2 Housing Supply Sector of Engineered Houses	6	Figure 1.1.14 Training Program for Seismic Adobe Houses by JICA, consisting of lectures (left), and OJT (on-the-job training) (right)	15
Figure 1.1.3 Housing Supply Sector of Non-engineered Houses	6	Figure 1.1.15 CARITAS poster for a community development project, including shelter provision (left), and participants in the project who had JICA training to build seismic adobe houses (right), Huangascar, Lima Province, Peru	16
Figure 1.1.4 Two Approaches to Bridging the Gap	8	Figure 1.2.1 Pressure and Release Model	18
Figure 1.1.5 Inadequate detailing of rebar connections (left), and bending of rebar on site with simple tools (right), in Banda Aceh, Indonesia	8	Figure 1.2.2 Disaster as an Opportunity for Transformation or Reinforcement of Pre-existing Inequalities	20
Figure 1.1.6 Typical Manner of Drawing the Bending of Rebar in Developed Countries	8	Figure 1.2.3 Connection of Women to Housing	21
Figure 1.1.7 Relationship between Relevant Items for Safer Non-engineered Houses	10	Figure 1.2.4. Reconstruction of buildings after disaster in Sri Lanka	22
Figure 1.1.8 Bricks eroded by rain (left), and cement mortar with void going through a brick wall (right), in Banda Aceh, Indonesia	10	Figure 1.2.5. Training program in Nepal	23
Figure 1.1.9 Demonstration with simple shaking table shows the significance of seismic design (collaboration between BRI and NSET, a Nepali NGO, in Banda Aceh, Indonesia in July 2006)	12	Figure 1.2.6. Facilities for vulnerable people after disaster	25
Figure 1.1.10 Training program for housing facilitators in Band Aceh, Indonesia in July 2006 by BRI	12	Figure 1.3.1. Overview of historical area of Khiva, with many historical monuments (left), and people living in old, traditional types of houses (right)	27
Figure 1.1.11 Shaking table experiment with a confined masonry structure which is popular in Indonesia, July 2008, at the National Research Institute for Earth Science and Disaster Reduction (NIED) in Tsukuba, Japan, organized by NIED and Mie University, in cooperation with BRI	13	Figure 1.3.2. Beautiful townscape provided by adobe houses in Villa Alegre, (left), and a renovated adobe building to be used as a post office in Malloa	28
Figure 1.1.12 Cyclic loading experiments of confined masonry walls (9 specimens), February and March 2009, at the Research Institute for Human Settlements, Department of Public Works (RIHS/DPU), Bandung, Indonesia, organized by Bandung Institute of Technology (ITB) and BRI. Setting up of specimen- and measurement equipment (left), and final stage of cyclic loading (right)	14	Figure 1.3.3. A dining room of a hotel of a renovated adobe building in Malloa (left), and a window that shows the characteristic thick walls of adobe buildings (right)	28
		Figure 1.3.4. Street view of a villa of restored adobe house in Zuniga, (left) and beautiful garden inside (right)	28
		Figure 1.3.5. A symbol of Lunahuana, a church in Lunahuana (left), and a historical building facing the Central Square of Lunahuana (right)	29



Figure 1.3.6 A community building constructed by the Lunahuana Municipality, which creates a historical townscape	29	Figure 2.2.9. Priority of Bridge Reinforcement	48
Figure 2.1.1 Three Components of Risk Assessment	31	Figure 2.2.10. Distribution of Isolation Risk by Road Blockage	49
Figure 2.1.2 Risk Management Cycle	31	Figure 2.2.11 Distribution of Gas Pipe Damage	49
Figure 2.1.3 Loss derived from Risk Curve	32	Figure 2.2.12 GEM Core functions	50
Figure 2.1.4 Sequence of Earthquake Disaster from the Viewpoint of Phenomenon	32	Figure 2.2.13. a) Physical risk and b) Integrated risk assessment for Ecuador	51
Figure 2.1.5 Sequence of Earthquake Disaster from the Viewpoint of Loss	33	Figure 2.2.14. GEM workshop (left), GEM group picture (right)	52
Figure 2.1.6 Scenario Earthquakes employed for Tokyo Metropolis	34	Figure 2.2.15. Working towards global coverage	52
Figure 2.1.7 Concept of probabilistic approach for single exposure	35	Figure 2.2.16. GEM workshop in Lalitpur, Nepal	53
Figure 2.1.8 Concept of probabilistic approach for multiple exposures	36	Figure 2.2.17. Flow of Community Earthquake-Risk Assessment	55
Figure 2.1.9 Two-step Approach to Evaluate Ground Motion Intensity at Surface	36	Figure 2.3.1. Questionnaire	57
Figure 2.1.10 Concept of the semi-empirical method	38	Figure 2.3.2. Perception of the Worst Possible Risk	58
Figure 2.1.11 Examples of vulnerability functions	39	Figure 2.3.3. Perception of the Worst Possible Natural Disaster Risk	58
Figure 2.1.12 Theoretical approach to obtain vulnerability	40	Figure 2.3.4. Belief in structural robustness of own housing against seismic risks	59
Figure 2.1.13 Example of seismic hazard map by NIED (National Research Institute for Earthquake and Disaster Prevention, Japan)	41	Figure 2.3.5. Actions taken by homeowners to reduce risks (multiple answers)	59
Figure 2.2.1 Features of Deterministic Risk Quantification Approach in the Project	43	Figure 2.3.6. Responsible person for the safety of a house	60
Figure 2.2.2 Fault Models of Scenario Earthquakes	44	Figure 2.3.7. Who is at fault in the case of housing collapse due to earthquake?	60
Figure 2.2.3 Ground Classification by Average S-wave Velocity	45	Figure 2.3.8. Reason for potential damages from earthquakes	61
Figure 2.2.4 PGA Distribution	45	Figure 2.3.9. Perception of potential damage from earthquakes	61
Figure 2.2.5 Percentages of Structural Type of Buildings in Istanbul	46	Figure 2.3.10. Workers' knowledge level of building code and technical guidelines provided by governments	62
Figure 2.2.6 Number of Heavily Damaged Buildings by Model C	46	Figure 2.3.11. Perception of who would be considered most responsible for damage to buildings and loss of lives due to earthquakes?	63
Figure 2.2.7 Empirical Relation of Building Damage and Death Toll in Turkey	47	Figure 2.3.12. Perception of potential largest contributor to the improvement of building safety in own cities	63
Figure 2.2.8. Flowchart of Risk Quantification both for Road Networks and for Bridges	48	Figure 3.1.1. Completed destroyed structure (Gorkha earthquake in 2015)	66

Figure 3.1.2. Location of epicenter	67	Figure 3.1.25. A house made of natural stone with mud mortar	75
Figure 3.1.3. Damages of houses (Sindhupalchowk Districts)	67	Figure 3.1.26. A school building made of dressed stone	76
Figure 3.1.4. RC frame with masonry infill walls in urban area	68	Figure 3.2.1. Ratio of construction types (unconfined masonry (left), confined masonry (right))	77
Figure 3.1.5. Out-of-plane failure in masonry walls	68	Figure 3.2.2. Comparison of compression strength (brick (left), concrete (right))	77
Figure 3.1.6. Separation of joints of walls (sides) and in-plane shear cracks (middle) in masonry walls	68	Figure 3.2.3. Collapsed buildings by the Northern Pakistan	79
Figure 3.1.7. Delamination of masonry walls	68	Figure 3.2.4. Failures often occurred in Earthquake 2005 in Balakot connections of structural members	79
Figure 3.1.8. Damages to RC-framed brick building (Sindhupalchowk District)	68	Figure 3.2.5. Drawings of bending works for reconstruction houses in Banda Aceh, Indonesia	79
Figure 3.1.9. Damaged adobe construction in Santiago	70	Figure 3.2.6. Construction practice on site Insufficient connection of longitudinal rebar	79
Figure 3.1.10. Damaged adobe construction located next to undamaged high-rise building in Talca	70	Figure 3.2.7. Bending works on site with simple tools Assembling of rebar is also conducted on ground	79
Figure 3.1.11. Damaged adobe construction in Nirihiulo in Maule Region	70	Figure 3.2.8. Placing the assembled rebar of a roof beam fabricated on ground	79
Figure 3.1.12. Adobe construction without appropriate maintenance work in Huerta del Maule in Maule Region	70	Figure 3.2.9. Concrete mixing on ground on site Mixing is carried out without sheets or others tools	81
Figure 3.1.13. Seismic intensity distribution (China Earthquake Administration)	71	Figure 3.2.10. Excavation works for foundation	81
Figure 3.1.14. Damaged house with hollow core slabs PCa	72	Figure 3.2.11. Laying work of bricks with plumb bob Taut line is usually used	81
Figure 3.1.15. The same building as in Figure 3.1.14. (Hollow core slabs were observed)	72	Figure 3.2.12. Corner of beams and column Length of lapped splices is limited to the dimension of RC members' section size because of fabrication method	81
Figure 3.1.16. Timber house that did not collapse	72	Figure 3.2.13. Form works Packing of small piece of cement bags is usually	81
Figure 3.1.17. Damaged concrete block house	72	Figure 3.2.14. Honey comb in beam Some of rebar is exposed to air observed	81
Figure 3.1.18. Damaged brick house	73	Figure 3.2.15. Concrete mixing on ground on site Mixing is carried out without sheets or other tools	82
Figure 3.1.19. Collapsed building due to failure of gable wall	73	Figure 3.2.16. Excavation works for foundation	82
Figure 3.1.20. Location of the epicenter	73	Figure 3.2.17. Bending works of rebar on ground with simple tools without machines	83
Figure 3.1.21. Connection failure	74	Figure 3.2.18. Connection of RC members Horizontal rebar for beams is not connected at the corner	83
Figure 3.1.22. A house made of various materials of natural stone (lower left), dressed stone (upper left) and bricks (right)	75		
Figure 3.1.23. A house made of solid concrete blocks	75		
Figure 3.1.24. Adobe house damaged by the earthquake	75		

Figure 3.2.19. Anchorage of walls to column	83	Box 4.2. Figure 3. Out-of-plane test (brick) (unreinforced (left) and reinforced by pp-band (right))	96
Figure 3.2.20. Laying work of bricks with taut line	83	Box 4.3. Figure 1. Construction of reinforced PCM wall	97
Figure 4.1.1. Small town in mountainous area (left), damaged light roof building (middle) and light roof brick masonry house (right)	86	Box 4.3. Figure 2. Q-R envelop curves for all test specimens	97
Figure 4.1.2. Shaking table and model structure	86	Box 4.4. Figure. 1. A non-engineered construction (left) and identified weak points by field survey (right).	98
Figure 4.1.3. Time-reduced Bam L(EW) wave and JIMA Kobe NS wave (response wave)	87	Box 4.4. Figure 2. Material test set-up and typical failure modes of the connections	98
Figure 4.1.4. Process of specimen collapse in the shaking table test (Excitation number 10)	87	Fig. 5.1.1 The relationship among stakeholders of engineered housing	101
Figure 4.1.5. Model structure after shaking	87	Fig. 5.1.2 Stakeholders and the relation "engineered houses"	102
Figure 4.1.6. Illustration of DEM and Extended DEM	89	Fig. 5.1.3 Direct approaches to users/ residents and workers	103
Figure 4.1.7. Illustration of the whole structure of analytical model (left) and element model of bricks and mortar (right)	89	Fig. 5.1.4 Approaches through engineering communities	105
Figure 4.1.8. Simulated process of collapse by the Bam earthquake wave (No. 9)	90	Fig. 5.1.5 Approaches through governmental organizations	106
Figure 4.2.1. Shotcrete, steel strip, re-pointing and post tensioning	93	Fig. 5.1.6 Approaches through NGOs	106
Figure 4.2.2. Old car tyre strips [REF4.13]	93	Figure 5.2.1 An example of technical guidelines (Manual for Earthquake Resistant Adobe Houses in Peru. Left: cover, right: an example of reinforcing with wire mesh)	116
Figure 4.2.3. Fiber-Reinforced Cement Matrix (FRCM) [4.16]	93	Figure 5.2.2 Cover of the Guideline by UNESCO	118
Figure 4.2.4. Fiber Reinforced polymer (aromatic polyamide fiber)	94	Figure 5.2.3 Typical damage to houses of undressed stone masonry with mud mortar, as shown in the Guideline (2005 Northern Pakistan Earthquake (Kashmir Earthquake)) Much typical damage to various types of structures are addressed	118
Figure 4.2.5. Engineered Cementitious Composite	94	Figure 5.2.4 Many illustrations are provided for easy understanding (an example showing inertia force caused by earthquake ground motion)	118
Figure 4.2.6. Jacketing (reinforcement concrete panel)	94	Figure 5.2.5 An illustration showing several types of damage in masonry buildings	119
Figure 4.2.7. Anchoring of reinforcement (steel panel)	94	Figure 5.2.6 An illustration showing a simple and easy field test for strength of adobe	119
Box 4.1. Figure 1. Appearance of reinforcement.(vertical rod of cane and horizontal crushed cane)	95	Figure 5.2.7 An adobe house in Nicaragua (Matthew French)	121
Box 4.1. Figure 2. Breakdown pattern Unreinforced building Reinforced building	95		
Box 4.2. Figure 1. Diagonal shear test (brick@40mm) (unreinforced (left) and reinforced by pp-band (right))	96		
Box 4.2. Figure 2. Stress-strain curve	96		

Figure 5.2.8 A confined block masonry building in Chile. From a report by Moroni, O, Gomez, C and Astroza, M.	121	Figure A.1.3. Visiting construction site for retrofitting (left)	
Figure 5.2.9 One of three publications on confined masonry housing	121	Group photo after lecture on shaking table test (right)	145
Figure 5.2.10 The tutorial on stone masonry construction	121	Figure A.1.4. Concrete slump test during a technical visit in a concrete block factory in Japan (left)	
Figure 5.2.11 The latest tutorial on building with confined masonry	122	Structural test in UCA, San Salvador (right)	145
Figure 5.3.1 Function of collar beams of one-story masonry building	128	Figure A.1.5 Observation of Matsushiro Seismological Observatory, Japan Meteorological Agency	146
Figure 5.3.2 Limits on openings in masonry walls	129	Figure A.1.6. Technical visit to historical district in Kyoto city where fire protection measures are implemented in ways so as to harmonize with historical cityscape (left)	
Figure 5.4.1 An illustration on the details of connection of beam and column in the decree on building permits by the Minister of Public Works and National Housing	132	Technical visit to experiment laboratory; participants experienced shaking motion on a shaking table (right)	147
Figure 5.4.2 Very simple and effective experiment with full scale model using tilting table	132	Figure A.1.7. Technical visit to large shaking table in Miki city, Hyogo Prefecture (left)	
Figure 5.4.3 Many wooden houses collapsed in the Kobe Earthquake 1995 (left), but new houses, following the revised code in 1981, suffered little damage, even in otherwise heavily damaged areas (right)	134	Lecture on safer non-engineered construction. Learning Indonesia's experience via video conference (right)	148
Figure 5.4.4 Break down of collapsed buildings by Kobe Earthquake in years of construction	134	Fig. A.2.1 A workshop before each phase of construction work	149
Figure 5.4.5 An example of pre-cut timber cut by numerical control cutting machines	136	Fig. A.2.2 Construction of a model house by participants under technical guidance of experts	149
Figure 5.4.6 Example of metal connectors. Brace to plinth/column type (left), column to beam type (middle) Certificate mark of quality assurance scheme (right)	136	Fig. A.2.3 Adobe bricks with canes for vertical reinforcement	149
Figure 6.1.1 The Relationship between Relevant Items for Safer Non-engineered Houses	138	Fig. A.2.4 Installation of horizontal reinforcement from crushed cane	149
Figure A.1.1 Field Visit in Yamakoshi District, Nagaoka City (left)		Figure A.2.5 Heavily damaged church (Adobe wall, vaulted roof made from quincha), Zuniga, Lima state	150
In Nagaoka: Earthquake Disaster Archive Center (right)	144	Figure A.2.6 Collapsed houses in central area of Zuniga, Lima state	150
Figure A.1.2 Field visit in Tohoku region to observe tsunami damage area (Onagawa Town) (left)		Figure A.2.7 House A: A model house in Zuniga, no structural damage	151
Field visit in Hirokawa town to observe Hiromura Seawall (right)	144	Figure A.2.8 House B: A house without reinforcement, next to House A	151
		Figure A.2.9 walls of an adobe house, House B	151
		Figure A.2.10 maged Heavy cracks in House B	151
		A.2.11 Poster image of Key Requirements	153

A.2.12 Typical image of reconstructed house	154	Figure A.3.2 Post-earthquake field investigation in Bohol, the Philippines, February 2014, members from Japan, Kazakhstan and UNESCO	160
A.2.13 A team of professional and non-professional builders	154	Figure A.3.3 Guidelines for Earthquake Resistant Non-engineered Construction published in August 2014	160
A.2.14 Seismic capacity experiment of a commonly used brick	156	Figure A.3.2. Relative level of engagement of S-T in SFDRR priority areas	164
Figure A.2.15 Structure for Project Implementation	156		
Figure A.3.1. IPRED Network and Action Plan	159		

## List of tables

Table 1.1.1 Comparison of Non-engineered and Engineered Houses	5	Table 3.1.1. Number of casualties	73
Table 1.1.2 List of Items and Sub-items for Safer Non-engineered Houses	11	Table 3.1.2. Destroyed and Damaged Housing Units in Pakistan	74
Table 1.2.1 Key Points for Future Projects that should focus on the Construction/ Management of Emergency Shelters, Temporary Housing, and Permanent Housing	26	Table 4.1.1. List of input waves and states of the model structure	88
Table 2.1.1 General Features of Risk Quantification Approach	33	Table 4.1.2. List of input wave used in the numerical simulation	90
Table 2.1.2 General Method of Risk Quantification	34	Table 5.1.1 Comparison of engineered and non-engineered construction	102
Table 2.1.3 Example of attenuation relations	37	Table 5.4.1 Category of buildings and relevant Nepal National Building Code (NBC)	130
Table 2.1.4 Products obtained in conducting risk quantification	40	Table 5.4.2 List of Mandatory Rules of Thumb and Guidelines	131
Table 2.2.1 Fault Parameters	44	Table A.1.1 Classification of IISEE International Training Courses	143

## List of Boxes

Box Story: Case of Tokyo: Seismic Risk Assessment for Community Use "Community Earthquake Risk Assessment"	54
Box 4.1 Cane-reinforced adobe building	95
Box 4.2 Masonry wallettes retrofitted by PP-band mesh	96
Box. 4.3 Seismic retrofit of unreinforced clay brick masonry using polymer-cement mortar	97
Box 4.4 Test for wind vulnerability assessment of non-engineered construction	98

# GUIDE FOR READERS

---

## INTRODUCTION

---

Every large-scale earthquake causes many casualties and huge property damage. Casualties and damage in developing countries is far worse compared with those in developed countries, especially casualties. The main cause of human casualties is the collapse of houses of low income people. They are usually called “non-engineered houses” or “non-engineered construction” as they are usually constructed without any involvement of engineers. In

spite of this situation, nonengineered construction attracts far less attention from the engineering community and policy makers.

Given this situation, UNESCO published a technical guideline entitled “Guideline for Earthquake Resistant Non-engineered Construction ” in August 2014. This is a sister publication of one for policy makers and leading engineers, which covers a wider range of social, economic, and administrative aspects.

### Contents of the Publication and Guide for Readers

This publication consists of the following chapters:

#### Chapter 1

Perspective for safer non-engineered construction

#### Chapter 2

Earthquake risks and perceptions by people

#### Chapter 3

Characteristics of non-engineered construction

#### Chapter 4

Technical approach for structural improvement of non-engineered construction

#### Chapter 5

Dissemination of technologies

#### Chapter 6

Towards resilient non-engineered construction

#### Appendix

If you are not familiar with the issues of non-engineered construction, it is advisable to read Chapter 1 first. It will provide you with a total perspective of the issues on non-engineered construction - not only technical issues - and you will see which chapters are relevant to your needs. If you are interested in specific fields, it is recommended to go directly to the chapters relating to your interest.

Chapter 2 discusses earthquake risk, what it means and how it is assessed. It also provides the risk perception of the key stakeholders, which is critical information in developing an effective implementation policy.

Chapter 3 describes technical aspects for policy makers and leading engineers, in order to get an overview of the vulnerability of non-engineered construction from reports of survey on damaged non-engineered construction and of monitoring on actual construction practice, which are basic information for policy making.

Chapter 4 shows a brief overview of technical approaches in a worldwide scope and several reports on basic experimental studies, meant to convince you that research is the foundation of establishment and development of policies and strategies for resilient non-engineered construction.

Chapter 5 focuses on social, economic and administrative aspects. From this you can understand that the dissemination of technology of non-engineered construction is far more difficult than that for engineered construction, and

motivating relevant stakeholders to apply it is another tough task. You will gain the basic knowledge of several types of guidelines as well, which are common tools for dissemination.

Chapter 6 shows a 'road map' to safer, non-engineered construction. The road map shows further steps such as supports for people and a collaborative platform for coordination among relevant stakeholders. This chapter also refers to necessity of environment for sustainable development, which is a possible way to reduce risk of huge number of non-engineered construction worldwide with limited resource.

The Appendix provides you with examples of programs, group training, technical-cooperation projects and networking initiatives, which may offer you some hints to taking action.

# CHAPTER 1

---

## PERSPECTIVE FOR SAFER NON-ENGINEERED CONSTRUCTION

---

### 1.0 Contents and Outline of Chapter 1

Every large-scale earthquake causes widespread social damage and, most tragically, human casualties. The main cause of human casualties is the collapse of houses of ordinary people, often called “non-engineered” houses because they are built with little or no intervention by engineers. Mitigation of damage to non-engineered houses is a critical issue. This chapter presents a perspective for safer non-engineered construction.

Firstly, the difference between engineered and non-engineered construction should be recognized. This implies that an effective approach for engineered-construction to enhance safety, does not work well for non-engineered construction, and a suitable approach for non-engineered construction is needed. Chapter 1 provides a perspective on safer non-engineered construction as basic knowledge. In addition to technical issues, it addresses the social and economic issues associated with such houses. Further it mentions the gender perspective and the cultural value of non-

engineered construction. The contents of Chapter 1 are as follows:

- Overview of Safer Non-Engineered Houses: Items to be Covered and Importance of Integrated Approach
  - Characteristics of non-engineered construction in comparison with engineered construction.
  - Relevant items to be discussed for creating a suitable approach for safer non-engineered construction. This includes technical items regarding 1) potential risk of earthquakes, 2) characteristics of each of house types, 3) technical solutions, and social and economic ones related to 4) dissemination of technical knowledge, 5) social and economic support for housing construction
  - Proposal of integrated approach.
- Significance of Integration of a Gender Perspective into Housing Issues
  - Critical issues related to gender in times of disasters and reconstruction including gendered vulnerability and coping capacity, and gender based violence



- Gender - and housing issues  
Recommendation of integration of a gender perspective in reconstruction from a disaster.
- Other Aspects of Non-Engineered Buildings - Cultural and Historical Value  
There are positive aspects of non-engineered construction due to their

cultural and historical value and they take actions more than strengthening structures. They sometimes restore or renovate them for new types of use. Also, they even construct non-engineered construction in improved traditional form. Examples of Chile and Peru are provided in this section.

## 1.1 Overview of Safer Non-Engineered Houses: Items to be Covered and Importance of Integrated Approach

### Two types of non-engineered construction (Focus on this publication)

Non-engineered construction can be categorized in 2 types. On one hand, there is the vernacular architecture that is adapted to local context and made with local materials. Its construction techniques are passed on from generation to generation. This architecture is often resilient to the local natural hazards. Moreover, vernacular architecture is culturally connected to its surroundings. The sociologic facet is reflected in its characteristics and the used spatial language. Traditional settlements are developed in harmony with their cultural and social environment and therefore foster social resilience to natural disasters. However, this type of construction needs sometimes to be improved to be more resilient to disasters without losing their own features. On the other hand, there is also non-engineered construction that is made with (partly) imported materials, often by using 'foreign' techniques. This construction is often copied from other countries but not adapted to the local situation because it is considered to be 'modern' or because donors implement local construction projects following the knowledge and practices from their

own country. Due to the lack of technical know-how, appropriate materials, accurate monitoring and concrete building regulations, this construction might be highly vulnerable to natural hazards.

In this publication, the focus is mainly on the latter non-engineered construction.

### Comparison of Non-Engineered and Engineered Houses

A great variety of non-engineered houses exists in the world: adobe or earthen houses in dry areas; stone masonry houses where stones are easily obtained; wood houses where timber is available; and brick houses where people accept and manufacture new types of materials. In the publication *Guideline for Earthquake Resistant Non-engineered Construction*, United Nations Educational, Science, and Cultural Organization (UNESCO) characterized non-engineered construction as "buildings which are spontaneously and informally constructed in the traditional manner without intervention by qualified architects and engineers in their design" (The Guideline is a recently revised version of a pioneer publication published in 1986, which has been one of the most complete and reliable technical documents in the

field.). In spite of the variety of materials that comprise non-engineered houses, we can find certain common characteristics, as shown in Table 1.1.1. It shows that differences between engineered and non-engineered houses exist not only in

technical respects, but also in relation to the workers who build them and users/dwellers, implying that the problems of non-engineered houses are not only technical, but are broadly related to social and economic issues.

**Table 1.1.1 Comparison of Non-engineered and Engineered Houses**

Items	Non-engineered	Engineered
Materials	Available in the area No quality control, etc.	Usually controlled in size, quality, etc.
Construction Workers	Non-skilled or semi-skilled workers	Skilled workers
Technical Intervention	Little or no intervention	Intervention in design, construction procedures
Users/dwellers	Low- or middle income	Middle- or high income

### Characteristics of Non-Engineered Houses

Figure 1.1.1 illustrates the comparison of non-engineered and engineered houses. The gray circle (in the lower-left quadrant), represents the distribution of non-engineered houses. It shows that the quality of most such houses falls under the level required by building codes or guidelines (the vertical axis), and the workers who build them, mostly non-skilled or semi-skilled (sometimes the house dwellers themselves), who have little opportunity to obtain technical information/training, fall under the required level (the horizontal axis). The size of the gray circle also shows that the range of quality of non-engineered houses and workers is wider. In contrast, the circle representing the distribution of engineered houses (in the upper-right quadrant) indicates that the quality of both the houses and the workers is usually above the required level. The workers are trained and often qualified under several types of qualification schemes, and construction of the houses themselves are subject to institutional procedures, such

as building permits, in which the design, detailing and quality of materials must meet technical standards and professional inspections.

We should also acknowledge the different structures of the respective houses supply sectors (i.e., the relationship between relevant stakeholders). In the case of engineered houses, the manufacturer of materials and the availability of professional workers with technical knowledge, together constitute a formal “housing supply sector,” as shown in Figure 1.1.2. In the case of non-engineered houses however, the manufacturer of materials and the workers of non-engineered houses are physically closer to the users/dwellers, usually in the same community. Sometimes the users/dwellers manufacture their own materials, such as adobe or timber, and construct houses with the help of family members or friends. They are usually untrained people with little or no access to engineering knowledge and training. The resulting gap between engineered and non-engineered houses is shown in Figure 1.1.3.

Figure 1.1.1 Comparison of Non-engineered and Engineered Houses

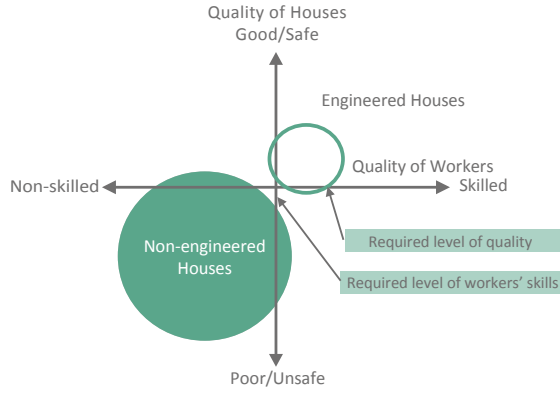

Figure 1.1.2 Housing Supply Sector of Engineered Houses

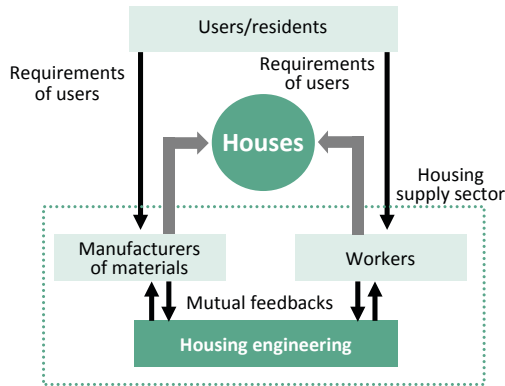
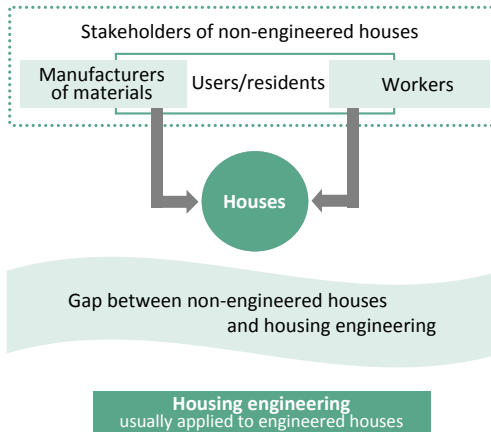

Figure 1.1.3 Housing Supply Sector of Non-engineered Houses



## Two Approaches to Bridge the Gap

In order to improve the quality of houses, lectures, workshops, and/or training programs are usually implemented, aiming at enhancing the skills of workers. This approach is shown by the arrow pointing in the upper-right direction in Figure 1.1.4. This approach can also be effective for non-engineered houses. Many good practices of training programs for non-engineered houses are found around the world. Care must be taken to provide a well-designed curriculum and tools, such as illustration, models, and/or mockups to help trainees who have little or no technical knowledge to be able to easily understand the training.

In the case of non-engineered houses, another significant approach is one that does not rely on improving the skills of workers. Workers of non-engineered houses do not have basic technical/engineering knowledge (usually given in schools) to absorb technical information, in comparison with workers who build engineered houses. An approach that aims to improve the quality of houses without the direct improvement of technical knowledge is shown by the upward-pointing arrow in Figure 1.1.4. This approach could be pursued through easier detailing, the provision of effective

equipment and machines, and the supply of well-designed components. For example, the bending of rebar is one of the most crucial issues in the construction of reinforced concrete members (columns, beams, etc.), and we often find inadequate detailing at the connections of beams and columns on construction sites (Figure 1.1.5). This is not only because of the poor workmanship of the workers, but also because of detailing of the overlapping of rebar, as required by the drawing, (Figure 1.1.6) cannot be accomplished with the simple tools available on the site (Figure 1.1.5). Easier detailing and construction methods, or more effective tools and facilities are typical improvements that approach would favor.

Supervision can be also categorized in this approach. Users/dwellers of non-engineered houses cannot usually afford to employ qualified supervisors. Possible solutions are to train users/dwellers themselves to play this role, or encourage them to turn to housing facilitators employed in community-based projects to support users. To promote this approach, dissemination activities are essential to enhance people's awareness of potential earthquake risks and of the basic knowledge of seismic construction.

Figure 1.1.4 Two Approaches to Bridging the Gap

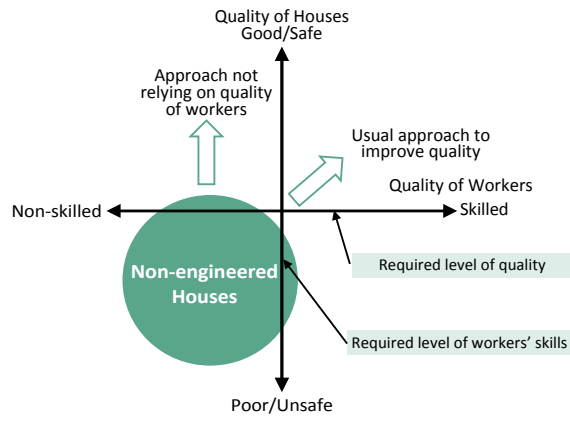
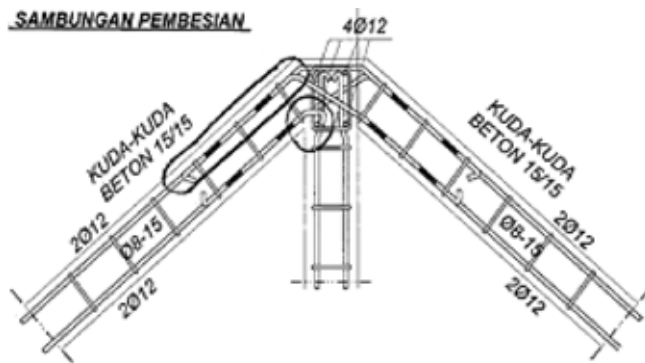

Figure 1.1.5 Inadequate detailing of rebar connections (left), and bending of rebar on site with simple tools (right), in Banda Aceh, Indonesia



Figure 1.1.6 Typical Manner of Drawing the Bending of Rebar in Developed Countries



## Key Issues for Safer Non-Engineered Houses: Appropriate Technologies and Their Dissemination

As shown by the example of confined masonry in Indonesia, the simple application of the technology of engineered houses does not work for non-engineered houses, where the facilities and tools are limited and the skill and knowledge of workers is insufficient (Figure 1.1.5 and 1.1.6). It is necessary to create feasible seismic-construction technologies that are appropriate for the existing facilities and tools that are used on construction sites and at the same time that are suitable for local workers with limited technical knowledge. These must also be affordable for users/dwellers, as most of those living in non-engineered houses are of low income and cannot afford to spend much on safety. These kinds of technologies are usually referred to as “Appropriate Technologies” and they are the key to the reduction of disasters.

How can appropriate technologies be delivered to the relevant people? In industrialized countries, building codes and technical standards are the usual measures for the dissemination of technical information. Dissemination to practicing engineers by professional associations and institutions, construction businesses, manufacturers, and researchers is also common. Furthermore, in developed countries, diffusion of technologies through administrative procedures, such as building permits and inspection by officials is common.

But these measures are not effective for non-engineered houses. It is necessary to deliver technical knowledge to workers such as those shown in Figure 1.1.5, and encourage them to apply it in their construction work. If there is no housing supply sector that consists of people in the engineering professions, dissemination through professionals is impossible. In addition, government administration services are usually ineffective for non-engineered houses. Non-engineered houses are sometimes not a governmental priority because each house is small and its individual impact on the environment is negligible, even though the number of such houses is very large. Therefore, it is necessary to seek other effective channels for disseminating technologies in order to construct safer non-engineered houses.

## Comprehensive Approach Embracing all Relevant Items for Safer Non Engineered Houses

Discussion of key issues and lessons from experience suggests that a comprehensive approach extending beyond key issues, to wider socio-economic realities, is needed in order to realize, in practice, a reduction in earthquake damage. A perspective of relevant issues and relationships among them is shown in Figure 1.1.7. Each of the relevant items is discussed individually below and details such as sub-items, actions and expertise needed, are shown in Table 1.1.2. There is further, detailed information on each item in the following chapters, as well.

Figure 1.1.7 Relationship between Relevant Items for Safer Non-engineered Houses

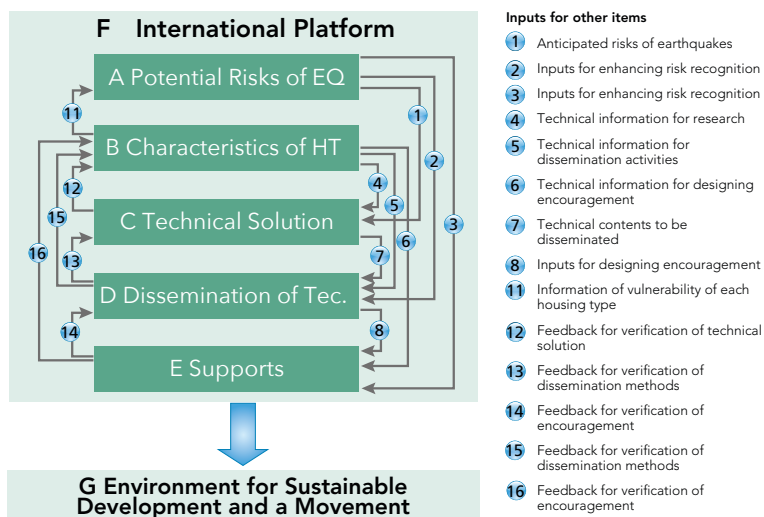

### A. Technical Solutions for Safer Houses

Appropriate technologies (C1 in Table 1.1.2) cover structural engineering, structural design, and construction methods. In addition to such expertise, we must pay attention to materials and components (C2 in Table 1.1.2) and work

to improve on-site construction practices (C3 in Table 1.1.2) (See Figure 1.1.8, which shows poor results due to low quality-materials and construction practices). The latter can be accomplished by improving - or introducing - effective tools and facilities, as well as by introducing practical construction methods and procedures.

Figure 1.1.8 Bricks eroded by rain (left), and cement mortar with void going through a brick wall (right), in Banda Aceh, Indonesia



Table 1.1.2 List of Items and Sub-items for Safer Non-engineered Houses

Items		Sub items		Action	Expertise/ Fields
A	Potential risks in case of earthquakes	1	Potential of earthquake occurrence	Anticipate future earthquakes with the magnitudes and return period	Seismology, Geology
		2	Seismic ground motion	Determine propagation and amplification of vibration and anticipate ground motion	Seismology, Geology, Soil Dynamics, Earthquake Engineering
		3	Potential risks of building damages	Estimate damages of buildings by anticipated ground motion	Earthquake Engineering, Structural Engineering
B	Characteristics of targeted housing types	1	Structures	Determine characteristics that influence earthquake damages, such as materials, supporting members against lateral forces (walls, reinforcing, etc), number of stories, etc.	Structural Engineering
		2	Materials and components	Specify physical characteristics of structural materials and components such as compression/ tensile strength, ductility and their dispersion	Engineering on Building Materials
		3	Construction technologies	Specify characteristics of construction methods/ procedures and tools/ facilities of construction works	Construction Engineering
		4	Skills of workers	Determine skills of workers who build targeted housing type	Construction Management
C	Technical solution for safer houses	1	Appropriate construction technologies	Promote structural engineering, structural designs, construction method, appropriate for each housing type for earthquake safety	Structural Engineering, Construction Engineering, Construction Management
		2	Appropriate materials and components	Improve materials and components or introduce new ones to promote earthquake safety	Engineering on Building Materials, Construction Engineering, Construction Management
		3	Improvement of on-site practices	Improve or introduce tools/ facilities and construction methods/ procedures for earthquake safety	Construction Engineering, Construction Management
D	Dissemination of technologies	1	Industries, engineers/ workers and administration (supply side)	Disseminate technical information/ recommendation to relevant groups such as construction workers , manufacturers of materials and components and government officials	Engineering Education, Dissemination of Technologies, Training of Engineers and Workers, R&D on Materials and Components, Circulation of Materials and Components, Policy for Building Industry, Building Permit
		2	People and community (demand side)	Educate and motivate users/ dwellers and their family members, community members (neighbors etc.) and their supporters like housing facilitators and volunteers	Disaster Education, Community Based Disaster Reduction
E	Supports for building users/ dwellers and community	1	Economic support	Provide subsidies, loans, donation of materials etc. to encourage investment in earthquake safety	Community Development, Policies and Strategies for Poor Groups
		2	Social supports	Support users/ residents' access to economic support and administrative procedures, such as building permits and settling of legal issues like land tenure, migration control	Community Development, Policies and Strategies for Poor Groups
		3	Collaboration	Collaborate with initiatives targeting low- and middle-income groups, such as public health, improvement of living condition, and community development projects	Community Development, Policies and Strategies for Poor Groups, Development Aid
		4	Collaborative platform for all stakeholders (governments, donors, NGOs and international organizations)	Establish a platform to support collaboration by stakeholders involved in activities E1, E2, and E3	Development Aid, International Cooperation, NGO Activities
F	International platform for exchange of information, lessons, and good practices		Establish an international platform to enhance the human resources devoted to reducing earthquake damage	All the relevant fields and sectors above	
G	Environment for sustainable development and a movement for safer houses		Prepare an environment to facilitate sustainable development that requires less financial and human resources through the activation of local economies and community development	Community Development, Development Aid, International Cooperation	



## B. Dissemination of Technologies

We need an effective way to deliver technical knowledge to workers (D in Table 1.1.2). Various approaches have been tried by governments, donors and international organizations, including the distribution of leaflets and the implementation of workshops and training programs.

In addition to supply side activities that target workers (D1 in Table 1.1.2), a demand side approach (D2 in Table 1.1.2) should also be pursued because users/dwellers could be the most reliable supervisors of the construction of their own non-engineered houses. In most

cases, users/dwellers cannot expect supervision by a government agency, nor can they afford to employ professionals. They themselves could be reliable supervisors if they acquired sufficient technical knowledge. For this purpose, donors and NGOs should organize workshops and demonstrations, with a focus on users (Figure 1.1.9). In the same context, workshops and training could be aimed at housing facilitators who are employed by donor-funded, community-based projects to facilitate the construction of houses by users/dwellers (Figure 1.1.10).

**Figure 1.1.9 Demonstration with simple shaking table shows the significance of seismic design (collaboration between BRI and NSET, a Nepali NGO, in Banda Aceh, Indonesia in July 2006)**



**Figure 1.1.10 Training program for housing facilitators in Band Aceh, Indonesia in July 2006 by BRI**



### C. Characteristics of Targeted Houses Types

We need precise and reliable technical information on the characteristics of each targeted housing type (B in Table 1.1.2). Most information accumulated so far is based on field surveys done after earthquakes, and the collapsing procedures are not yet fully clarified. A research group organized by the Building Research Institute (BRI) conducted a comprehensive experimental study consisting of strength tests of materials and components, cyclic

loading experiments, and shaking table experiments to comprehend the behavior of structures during shaking motions (Figure 1.1.11 and 1.1.12: Detailed information on the experiments is reported in Chapter 4).

To understand actual on-site construction practices, it is recommended that monitoring surveys on construction sites be conducted to grasp the total procedure, from earth work, foundations, RC work, brick work, and roof construction, to finishing work.

**Figure 1.1.11** Shaking table experiment with a confined masonry structure which is popular in Indonesia, July 2008, at the National Research Institute for Earth Science and Disaster Reduction (NIED) in Tsukuba, Japan, organized by NIED and Mie University, in cooperation with BRI

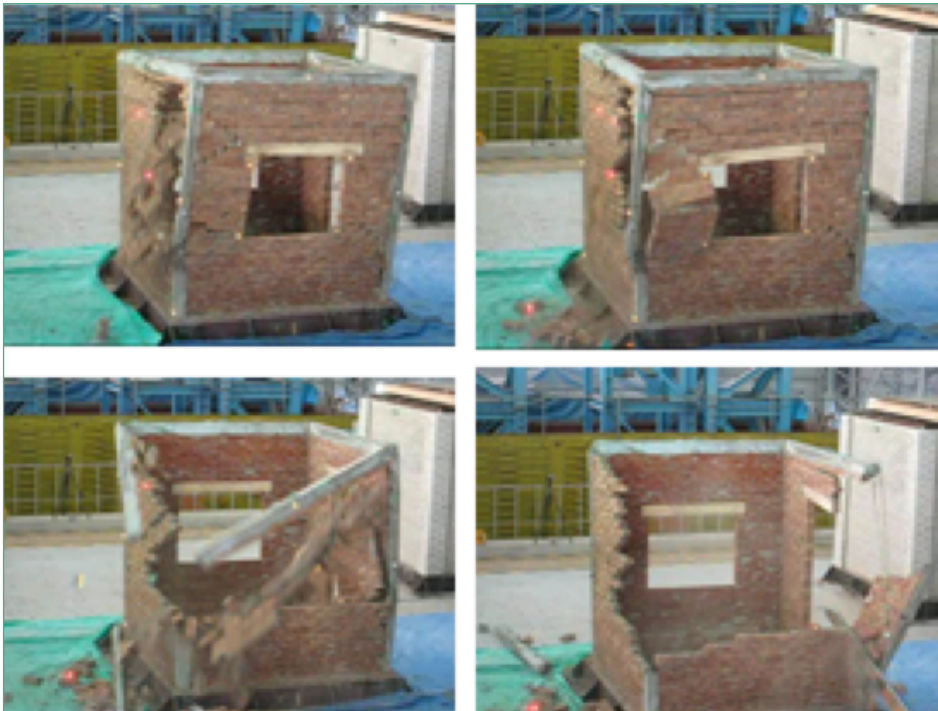

**Figure 1.1.12** Cyclic loading experiments of confined masonry walls (9 specimens), February and March 2009, at the Research Institute for Human Settlements, Department of Public Works (RIHS/DPU), Bandung, Indonesia, organized by Bandung Institute of Technology (ITB) and BRI. Setting up of specimen- and measurement equipment (left), and final stage of cyclic loading (right)



#### **D. Potential Risks in Case of Earthquakes**

Potential risk is the starting point of all efforts for safer houses (A in Table 1.1.2). Scientific expectations concerning the scale of earthquakes occurring in each area and their reoccurrence periods are essential information (A1). In order to predict damage, we also need research results on the effect of the ground motion by earthquakes (A2) and vulnerability data for each housing type to evaluate the risks of damage to houses (A3). This information should be delivered to relevant stakeholders to motivate them to work for safer houses.

#### **E. Support for Users/Dwellers and Communities for Building**

Since houses are expensive property, and safer houses require further investment, economic encouragement in the form of subsidies, loans or the donation of materials is necessary (E1 in Table 1.1.2). Social support is also needed as most users/dwellers of non-engineered houses are unfamiliar with administrative and documentation procedures, such as

building permits and applications for subsidies. (E2 in Table 1.1.2) Housing facilitators in community-based projects can lend support of this nature. (Figure 1.1.10) In the reconstruction project after the 2006 Central Java earthquake, the Indonesian Government established a division of local government dedicated to providing consultation for people regarding building permits and building-subsidy applications in order to meet this challenge (Figure 1.1.13).

Collaboration with other initiatives that target low- and middle-income groups (E3) is another effective way to support users/dwellers, as these are more commonly implemented in longer duration than those aimed at either reduction of earthquake disasters or reconstruction after earthquake disasters. One example of successful continuation is found in Peru. A JICA (Japan International Cooperation Agency) project called the Training Program for Seismic Adobe Houses was succeeded by the international NGO, CARITAS in their community development projects in mountainous areas in Peru aimed at the

enhancement of agricultural productivity and the improvement of living conditions. They find that adobe is a suitable type of housing construction there, and they employ the seismic design of adobe

houses, as the design was disseminated by JICA (Figure 1.1.14). The participants in JICA training programs play a big role in CARITAS initiatives (Figure 1.1.15).

**Figure 1.1.13** A district government office in the Special Province of Yogyakarta, Indonesia, dedicated to providing consultation for housing reconstruction (above), and a JICA capacity development program for local government officials (below)



**Figure 1.1.14** Training Program for Seismic Adobe Houses by JICA, consisting of lectures (left), and OJT (on-the-job training) (right)



**Figure 1.1.15 CARITAS poster for a community development project, including shelter provision (left), and participants in the project who had JICA training to build seismic adobe houses (right), Huangascar, Lima Province, Peru**



#### **F. Collaborative Platform for All Stakeholders**

Initiatives and activities to reduce disasters in non-engineered houses require various stakeholders, including local- and central governments, professional consultants, engineers, and social workers, donors, NGOs and international organizations. The number of stakeholders and the wide range of their activities require a platform for the exchange of information and coordination of activities to ensure effective implementation in each area or country (E4 in Table 1.1.2).

#### **G. International Platform**

The reduction of earthquake disasters in non-engineered houses is an urgent global issue. As the accumulation of lessons and experience is, by itself, insufficient, it is desirable to establish an international platform to support advances in all relevant fields and sectors (F in Table 1.1.2). Several examples can be found of such initiatives that already exist; the World Houses Encyclopedia (WHE), the Earthquake Engineering Research Institute (EERI), IISEE Net, the

International Institute of Seismology and Earthquake Engineering of the Building Research Institute (IISEE/BRI), and the International Platform for Reducing Earthquake Disasters (IPRED), UNESCO. These are platforms for researchers in the fields of earthquake engineering and seismology, which cover items A, B, and C in Table 1.1.2; platforms are needed that cover items D and E. For vernacular architectures, there are international platforms such as International Council for Monuments and Sites (ICOMOS) Committee, The International Scientific Committee on the Analysis and Restoration of Structures of Architectural Heritage (ISCARSAH) and International Committee on Risk Preparedness (ICORP) with accumulation of knowledge and experience.

#### **H. Environment for Sustainable Development and a Movement for Safer Houses**

Finally, it is recommended to establishment an environment for sustainable development and a movement for it, in which each community is supported for a certain period in the

reduction of risk, and is then expected to continue the movement with less financial and social support from outside (G in Table 1.1.2). Since the number of communities that need support for disaster risk reduction is enormous and resources are limited, the environment for a sustainable commitment is needed.

### I. Proposing a Comprehensive Approach

Figure 1.1.7 illustrates the relationship between the relevant items discussed above. It suggests that a comprehensive approach that features awareness of all items and collaboration between all stakeholders could enhance the effectiveness of the efforts of each, as non-engineered construction problems consist of technical, social and economic aspects, and require the participation of various sectors, such as governments, engineers, researchers, NGOs and donors. Because resources are limited, collaboration in the sharing of knowledge and lessons and a comprehensive approach to attaining safer non-engineered houses is highly recommended.

### Reference

1. Tatsuo Narafu, Yuji Ishiyama, Kenji Okazaki, Shoichi Ando, Hiroshi Imai et al (2010), A Proposal for a Comprehensive Approach to Safer Non-engineered Houses, *Journal of Asian Architecture and Building Engineering (JAABE)*
2. A. S. Arya, Teddy Boen, Yuji Ishiyama (2014) *Guidelines for Earthquake Resistant Non-engineered Construction*, United Nations Educational, Science, and Cultural Organization (UNESCO)
3. UNISDR (United Nations International Strategy for Disaster Reduction) (2004) *Living with Risk: 2004 version*
4. Tatsuo Narafu, Hiroshi Imai, Keiko Sakoda, Yuji Ishiyama and et al. (2008) *Basic Study for Bridge between Engineering and Construction Practice of Non-engineered Houses*, *Proceedings of 14<sup>th</sup> World Conference of Earthquake Engineering (14WCEE)*
5. Tatsuo Narafu, Yuji Ishiyama, Kenji Okazaki, Shoichi Ando, and Hiroshi Imai (2008) *Strategic Approach to Mitigate Human Casualties by Large Scale Earthquakes "Engineering for Safer Non-engineered Houses"*, *Proceedings of 14<sup>th</sup> World Conference of Earthquake Engineering (14WCEE)*
6. Kenji Okazaki and Tatsuo Narafu (2008) *Reconstruction Practice in Aceh after 2004 Tsunami Disasters*, *Proceedings of 14<sup>th</sup> World Conference of Earthquake Engineering (14WCEE)*
7. Kenji Okazaki and Tatsuo Narafu (2007) *Houses Reconstruction Practices in Aceh, Indonesia*, *Journal of Architecture and Planning (Transaction of AIJ)*, Architectural Institute of Japan (AIJ) No.619, 257-262.

There is an amount of international references on vernacular architectures and ways of making them earthquake resistant.

## 1.2 Significance of integration of a Gender Perspective into Housing Issues

### Disaster from a Social Science Perspective

From a social science perspective, how a disastrous event is understood and experienced differs among people and across time and space<sup>1</sup>. Based on this recognition, the concept of disasters has been addressed with the key words of 'risk' and 'vulnerability' which are also subjective. Natural hazards are not always produced as disasters since disasters are products of the intersection of hazards and vulnerability<sup>2</sup>. Blaikie et al. focus on what causes vulnerability, rather than

the severity of the hazard, because the former is a more critical determinant to differentiate the level of the risk to which different groups of people are exposed (See Figure 1.2.1). Disasters are constructed through everyday social, economic and political processes, all of which are unequal and discriminatory, thus requiring transformation.<sup>3</sup> In this light, the power relations and inequalities that are structured by gender, class, ethnicity, age and physical ability must be a key to how we interpret the complex concepts of vulnerability and disaster.<sup>4</sup>

- 1 Bradshaw, Sarah. 2013 (pp.1). *Gender, Development and Disasters*. Cheltenham. UK: MPG Print Group.
- 2 ibid.; Flint, M. and Luloff, A.E.. 2005. "Natural resource-based communities, risk and disaster: An intersection of theories." *Society and Natural Resources*. 18, pp. 399-412; Oliver-Smith, A. 1998. "Global changes and the definition of disaster" in Quarantelli, E. E. (ed.) *What is a Disaster? Perspectives on the Question*. London and New York: Routledge.

3. Blaikie et al. 1994. *At Risk: Natural Hazards, People's Vulnerability, and Disasters*. London: Routledge.; Hewitt, K. 1997. *Regions of Risk: A Geographical Introduction to Disasters*. Harlow: Longman.; Phillips, B.D. and Morrow, B. H. (ed.) 2008. *Women and Disasters from Theory to Practice*. USA: Xlibris Corporation.
4. Bradshaw, Sarah. 2013, *Gender, Development and Disasters*. Cheltenham. UK: MPG Print Group.; Enarson, E. and Morrow. B.H. (ed.) 1998. *The Gendered Terrain of Disasters: Through Women's Eyes*. Westport, Ct: Praeger Publishers.

Figure 1.2.1 Pressure and Release Model<sup>5</sup>

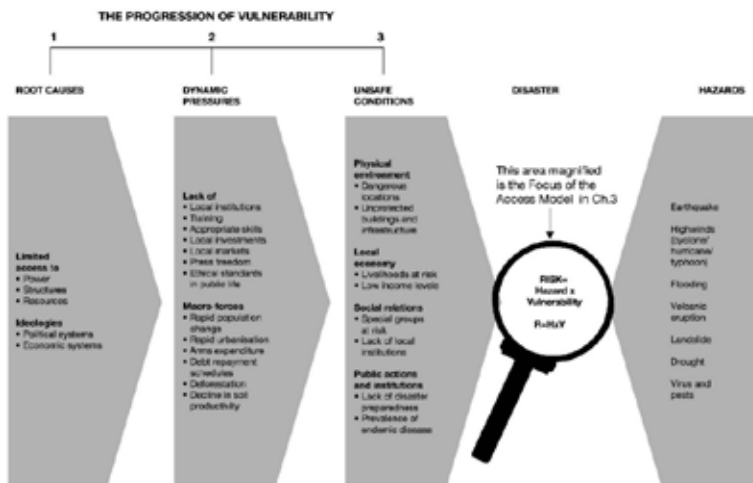

5. Blaikie et al. 1994. *At Risk: Natural Hazards, People's Vulnerability, and Disasters*. London: Routledge.

## Gendered Vulnerability and Coping Capacity

Despite a key determinant for vulnerability, gender is still invisible, or at least systematically simplified and stereotyped, largely by the dominant perspectives of the field of disaster. The current tone of ‘feminization of disaster’ is partly a result of oversimplification of the gendered implication of disaster.<sup>6</sup> Vulnerability does not lie with being a woman, but with the lack of access to the resources necessary for coping with hazards, which is gendered<sup>7</sup>. Without addressing the root causes of gendered vulnerability, the media and aid agencies often portray women as helpless victims, for the benefits of the media and aid agencies. This tends to lead to a systematic neglect of women’s coping capacity, their leadership, and diversity among women. The media and aid agencies also create the images of women as better mothers who try to care for their sickly and hungry children in post-disaster contexts. This can reinforce stereotypical images of women as mothers first and foremost,<sup>8</sup> not as main actors who can play a big role in disaster recovery and disaster risk reduction.

From a gender perspective, disaster is a great opportunity to redistribute resources among marginalized groups of people and transform traditional gender roles and

unequal gender relations.<sup>9</sup> On the other hand, disasters can also deepen such pre-existing inequalities,<sup>10</sup> depending on how governmental- and external organizations address the transformation of the power relations and inequalities structured by gender, class, ethnicity, age and physical ability (See Figure 1.2.2). Bradshaw and Arenas argue that the majority of plans for reconstruction, made by both governmental and non-governmental organizations, have tended not to include gender roles and gender relations as part of their vision for transformation<sup>11</sup>. In this light, aid agencies should not only meet the demands of women’s daily life (practical gender needs), but should also challenge traditional gender roles and unequal gender relations (strategic gender needs) through their post-disaster recovery/ reconstruction projects. This can increase women’s coping capacity, as well as agency and leadership in disaster risk reduction, which may lead to more equal communities and resilient communities.

6. Bradshaw, Sarah. 2013. *Gender, Development and Disasters*. Cheltenham. UK: MPG Print Group.

7. *ibid.*

8. *ibid.* (pp 264)

9. *ibid.*; IRP. 2009. “Gender issues in recovery.

Executive briefs for recovery: Extracts from key documents series,” compiled by IRP.; Lipman-Blumen, Jean. 1984. *Gender Roles and Power*. Englewood Cliffs, NJ: Prentice-Hall.; Enarson, E. and Morrow. B.H. (ed.) 1998. *The Gendered Terrain of Disasters: Through Women’s Eyes*. Westport, Ct: Praeger Publishers.; Phillips, B.D. and Morrow, B. H. (ed.) 2008. *Women and Disasters from Theory to Practice*. USA: Xlibris Corporation.

10. Anderson, M. 2011. *Disaster Writing: The Cultural Politics of Catastrophe in Latin America*, Charlottesville, VA: University of Virginia Press.

11. Bradshaw, S. and Arenas, A. 2004. “Análisis de género en la evaluación de los efectos socioeconómicos de los desastres naturales,” Commission Económica para América Latina y el Caribe (CEPAL), Serie Manuales 33. Cited in Bradshaw, S. 2013. *Gender, Development and Disasters*. Cheltenham. UK: MPG Print Group.



Figure 1.2.2 Disaster as an Opportunity for Transformation or Reinforcement of Pre-existing Inequalities

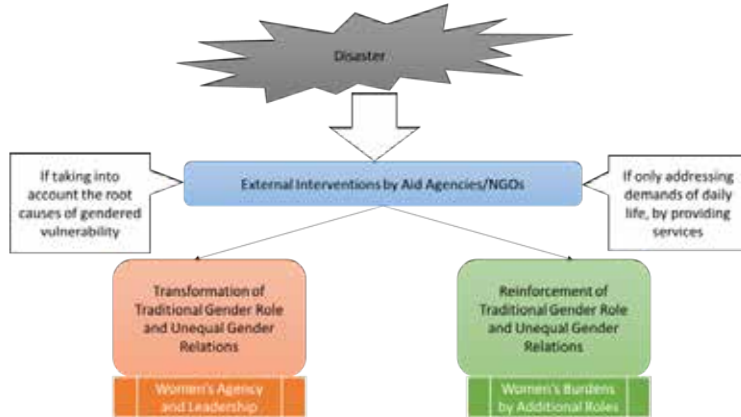

Developed by the author

## Gender and Housing Issues

From a Gender and Development perspective, housing issues are closely related to poverty and gender.<sup>12</sup> Poor families tend to live in unsafe and disaster-prone areas, such as in a riverside area or on a slope.<sup>13</sup> Regardless of location, their housing also tends to be constructed very simply and, thus is vulnerable to earthquakes, strong winds, heavy rain or other extreme climate events. However, such risks and vulnerability to disaster are different between men and women, intersecting with class. In Bangladesh, very poor families reside in flood-prone areas, such as in *chars*, which are river islands formed from sedimentation. Due to the gender division of roles and space, male dwellers in *chars* are usually engaged in wage-labor outside *chars* during the day

time, while female dwellers always stay at home, and are thus more exposed to a risk of a flood<sup>14</sup>. On the other hand, in the 1985 Mexico City earthquake, the majority of houses destroyed were headed by low-income, single women, who supported their families through informal sector work based in and around their houses.<sup>15</sup>

The loss of housing tends to affect women more, psychologically and economically, than men, based on the gender division of roles, and rights' to the land and housing. When women lose their housing, they are often traumatized and stressed by no longer being able to fulfill their responsibilities as food providers and

- .....
12. Enarson, E. 2008. "Women and Housing Issues in Two U.S. Disasters: Hurricane Andrew and the Red River Valley Flood." in Philipps and Morrow (ed.) 2008. *Women and Disasters from Theory to Practice*. USA: Xlibris Corporation.
  13. Blaikie et al. 1994. *At Risk: Natural Hazards, People's Vulnerability, and Disasters*. London: Routledge.

- .....
14. Chowdhury, Mahjabeen. 2001. "Women's Technological Innovations and Adaptations for Disaster Mitigation: A Case Study of *Charlands* in Bangladesh." prepared for DAW/ISDR Expert Group Meeting on "Environmental Management and the Mitigation of Natural Disasters: A Gender Perspective" in Nov. 2001, in Ankara, Turkey.
  15. Dufka, C. 1988. "The Mexico City Earthquake Disaster." *Social Casework: The Journal of Contemporary Social Work* 69: 162-170.

caretakers.<sup>16</sup> When impoverished women who make a living through informal sector home-based work/business lose their housing, they also lose a source of income. This is particularly difficult for women who are heads of households.<sup>17</sup> More critically, in such a patriarchal society as rural Sri Lanka, many widows

who lost their husbands in the tsunami also lost their rights to landownership when their husbands passed away, as property that was owned by the husbands was taken away by the husbands' male family members or relatives. On the other hand, in the post-tsunami relocation project in Sri Lanka, supported by the government of Japan, both male- and female beneficiaries were involved in an explanation session on how the ownership of the land and housing would be handed over to them.

16. Enarson, E. 2008. "Women and Housing Issues in Two U.S. Disasters: Hurricane Andrew and the Red River Valley Flood." in Philipps and Morrow (ed.) 2008. *Women and Disasters from Theory to Practice*. USA: Xlibris Corporation.  
 17. *ibid.*

Figure 1.2.3 Connection of Women to Housing

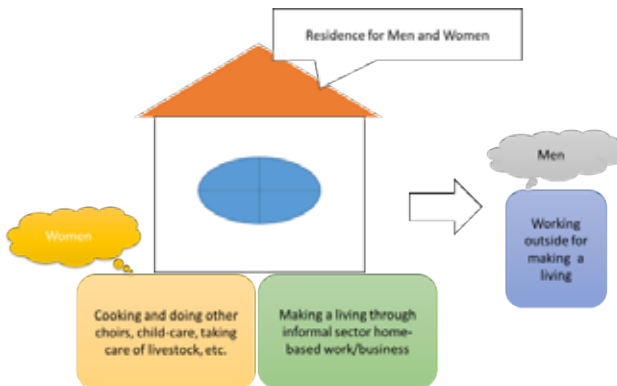

Developed by the author

Due to their stronger connection to housing, women actually play a crucial role in housing issues. Following the Latur earthquake in India, local women organized neighborhood groups to monitor construction work for possible corruption, collectively purchase construction materials and build model housing that suited their needs.<sup>18</sup> In the aftermath of the 1985 Mexico City Earthquake, women were highly active in organizing community resistance to enforced relocation, echoing the activism

of women around housing issues.<sup>19</sup> In the relocation projects post-Typhoon Haiyan (Yolanda), implemented in Leyte in the Philippines, Oxfam invited affected women to a three-month training program on carpentering so that the trained women took opportunities of 'cash for work' for the construction of permanent housing for them. In a post-tsunami relocation project implemented in Trincomalee District, Sri Lanka by the government of Japan, women beneficiaries were also involved in

18. *ibid.*

19. Serrat Vinas, Carolina. 1998. "Women's Disaster Vulnerability and Response to the Colima Earthquake." in Enarson and Morrow (ed.) *The Gendered Terrain of Disaster*. Westport, CT: Praeger Publishers.

the workshop to select model housing out of a few for their permanent housing.

In Nepal, women, as potential housing builders, were involved in a community-based training program conducted by the Nepal Society for Earthquake Technology (NSET) in collaboration with the Office of Ward 17, Kathmandu Metropolitan City and Ward Disaster Management Committee. This training was carried out in December 2007 as a part of NSET's joint project with the National Graduate Institute for Policy Studies (GRIPS), Japan. Some women participants in the program were potential housing builders who were planning to build their own housing in the near future, while others had already applied for the approval of their new housing designs and drawings from the municipality.

The training focused mainly on technology to construct safer housing in terms of structural and non-structural safety. It also included a field visit to some construction sites so that the participants of the training could observe and learn all the details of construction work. This attracted other neighboring Wards to involve women in such training as necessary for potential housing builders. From a gender perspective, this was a great opportunity for the women participants to not only acquire the knowledge necessary for building their own housing, but also as an appeal to their society to accept the transformative image of women, as they break with tradition and share a role previously held almost exclusively by men.

**Figure 1.2.4. Reconstruction of buildings after disaster in Sri Lanka**



*Permanent housing provided by the government of Japan in Iqbal Nagar, Kuchchaveli, Trincomalee, Sri Lanka (Photo: July 2015)*



*Community center provided by the Government of Japan in Iqbal Nagar, Kuchchaveli, Trincomalee, Sri Lanka (Photo: July 2015)*

Figure 1.2.5. Training program in Nepal



Women participants in the training program on technology for safer housing, conducted in Kathmandu, Nepal. They are practicing the use of a non-structural safety kit.

In many cases, however, based on gender biases, disaster-affected women are often excluded from camp management processes and housing issues in the emergency response- and recovery phases. For example, some Muslim women among tsunami survivors in Iqbal Nagar, Kuchchaveli Division, Trincomalee District, Sri Lanka who evacuated to a tent village, constructed next to a mosque, were excluded from their camp management committee. Based on an interview conducted in July 2015 by Atsuko Nonoguchi, the committee, consisting of only male members, tried to solve problems by themselves or requested NGOs for support. Whenever the women faced problems related to bathrooms and drinking water, they first needed to talk to their husbands, and had to wait for the husbands to raise the issues with the committee, then the committee consulted

with the relevant NGOs. Similarly, after they moved into temporary housing supported by a local NGO, both Muslim and Tamil groups of dwellers were not encouraged by the NGO to involve women members in their camp management committees. The camps were left to be managed by only male members.

## Gender Based Violence

The risk and vulnerability of women and other marginalized groups of people are not always located in private housing in pre-disaster circumstances, but even in the public space of evacuation centers and temporary housing during the emergency response- and post-disaster recovery phases. During the phase of emergency response, not all people have equal access

to an evacuation center.<sup>20</sup> Cultural barriers may place women, more so than men, at risk where the social institutions/norms of women's lack of mobility and their seclusion, *purdah*, are strictly enforced, and early warnings for evacuation are less accessible for women.<sup>21</sup> The elderly, people with disabilities, pregnant women and women with small children, who are often identified as the most vulnerable, face difficulties in moving to an evacuation center by themselves. In an evacuation center, they often need their own private space for changing clothes, breast-feeding, relaxing, and so on, but such a special attention is not always given in all communities.

In the contexts of aftermath and post-disaster, one of the most severe problems faced by women is gender based violence (GBV). While women tend to experience more emotional trauma and anxiety, men may be more likely to suffer from alcohol abuse during the recovery phase, largely resulting from economic stress.<sup>22</sup> Alcohol abuse by men, associated with power

inequalities between them and women, can drive them to abuse their wives more than in a normal context. Although there is no supporting documentation, domestic violence against wives increased in the wake of Hurricane Andrew.<sup>23</sup> Those women survivors were not able to resist violence by their husbands, due to a social stigma, their economic dependence on their husbands, and their fear of abandonment by their husbands.<sup>24</sup> On the other hand, women with disabilities are more likely to be sexually harassed or assaulted in an evacuation center, where they are not often assured to have a private- or a safe space.<sup>25</sup> As Philipps and Morrow suggested, community-based DRR planning should include shelters and services for battered women.

After the 2013 Typhoon Haiyan, the Philippine government addressed GBV through their post-disaster cluster approach. In cooperation with UNFPA, the Department of Social Welfare and Development (DSWD) under the government of the Philippines set up what they call 'Women Friendly Space', in some of the affected areas in Leyte, where the facilitators who were trained provided counselling services and legal information on GBV to victims. In a bunk house in

- .....
20. Enarson, E. 2008. "Women and Housing Issues in Two U.S. Disasters: Hurricane Andrew and the Red River Valley Flood." in Philipps and Morrow (ed.) 2008. *Women and Disasters from Theory to Practice*. USA: Xlibris Corporation.
  21. Ikeda, Keiko. 1995. "Gender Differences in Human Loss and Vulnerability in Natural Disasters: A Case Study from Bangladesh." *Indian Journal of Gender Studies*, Vol. 2, No. 2, Pp. 171-193.
  22. Fothergill, Alice. 1998. "The Neglect of Gender in Disaster Work: An Overview of the Literature," in Enarson and Morrow (ed.) *The Gendered Terrain of Disaster*. Westport, CT: Praeger Publishers.; Philipps and Morrow (ed.) 2008. *Women and Disasters from Theory to Practice*. USA: Xlibris Corporation.

.....

23. *ibid.*

24. Bradshaw, Sarah. 2001. "Reconstructing roles and relations: women's participation in reconstruction in post-Mitch Nicaragua." *Gender and Development*, Vol. 9, No. 3, pp. 79-87.

25. Philipps and Morrow (ed.) 2008. *Women and Disasters from Theory to Practice*. USA: Xlibris Corporation.

Tacloban City in Leyte, one room was allocated for the provision of counselling and other services to victims of residents in the bunk house. An official who belonged to DSWD was regularly stationed there.

One member of the camp management committee that was formed in the bunk house took responsibility for GBV issues and closely worked with the official of DSWD.

**Figure 1.2.6. Facilities for vulnerable people after disaster**



*Women-Friendly Space in Tolosa Municipality, Leyte, the Philippines (Photo: July 2015)*



*Bunk House in Tacloban City, Leyte, the Philippines (Photo: July 2015)*

### Recommendations for Future Disaster-Reconstruction Interventions in terms of Housing Issues

Based on the literature reviewed above, as well as the lessons learnt from a couple of the past post-disaster recovery/reconstruction projects examined above,

there are key points that should be taken into account for future DRR projects that focus on the construction of emergency shelters, temporary housing and permanent housing. The main points to be considered at each phase of a disaster are shown in the following table:

**Table 1.2.1 Key Points for Future Projects that should focus on the Construction/Management of Emergency Shelters, Temporary Housing, and Permanent Housing**

	Emergency Shelters	Temporary Housings	Permanent Housings
Gender-specific Needs during Emergency Response/Recovery Phase	hearing from women, elderly people, people with disabilities about their needs	hearing from women, elderly people, people with disabilities about their needs	-
	providing sanitary/hygiene goods to women	-	
	ensuring to set up private space for the elderly, people with disability, pregnant women, and women with infants	ensuring to set up private space for the elderly, people with disability, pregnant women, and women with infants	
	ensuring special space for changing clothes for women, breast-feeding, and counselling for victims of GBV	ensuring special space for changing clothes for women, breast-feeding, and counselling for victims of GBV	
	ensuring private and separated bathrooms for women which are safe from GBV	ensuring private and separated bathrooms for women which are safe from GBV	
	requesting the police for night patrol if necessary	requesting the police for night patrol if necessary	
Camp Management during Recovery Phase	not letting women take a role in cooking and taking care of children, elderly people, etc. based on traditional gender division of role	involving women in location selection, layout and design of temporary housing especially from view points of access to drinking water and fuel and convenience for cooking, care of children and elderly people, etc.	-
	involving women in the decision-making body for camp management	involving women in the decision-making body for camp management	
	appointing a member-in-charge for taking measures against GBV in the committee and allocating a room for counselling for GBV victims	appointing a member-in-charge for taking measures against GBV in the committee and allocating a room for counselling for GBV victims	
Construction of Housings during Reconstruction Phase	-	-	involving women in the planning process sharing information on the planned housings to be provided, listening to women's needs based on their role, and reflecting their voices in the planning, especially in terms of accessibility to drinking water, fuel, etc. and convenience for home-based work, cooking, taking care of livestock, etc.
	-	providing skills and knowledge on carpentering for the construction of housings providing 'cash for work' for the construction of housings to women and people with disabilities	providing skills and knowledge on carpentering for the construction of housings providing 'cash for work' for the construction of housings to women and people with disabilities
	-	-	providing necessary information on the right over the property of the land and housings to be provided so that women do not lose their property rights

*Developed by the author*

### 1.3 Other Aspects of Non-Engineered Buildings: Cultural and Historical Value

#### Cultural and Historical Value Created by Non-Engineered Buildings

Historical cities/areas have cultural value and attract many tourists. The value is not only due to monuments, but also because

of the many buildings in those areas. Buildings and houses constructed in the same or similar manner create a historical townscape and atmosphere. They provide places for dwelling, shops, workshops and so on for residents, and accommodation and souvenir shops for visitors. A historical

area of Khiva (in the inner part of the town), Uzbekistan, a World Heritage Site of UNESCO, has many historical monuments, but far more buildings and housing constructed and inhabited by 'ordinary' people. These buildings are the first types of non-engineered constructions that is described in 1.1 as vernacular architecture that is adapted to local context and made with local materials. Its construction techniques are passed on from generation to generation. This architecture is mostly

resilient to the local natural hazards. Moreover, vernacular architecture is culturally connected to its surroundings. The sociologic facet is reflected in its characteristics and the used spatial language. Traditional settlements are developed in harmony with their cultural and social environment and therefore foster social resilience to natural disasters. In the following sub sections, examples in Chile and Peru are given.

**Figure 1.3.1 Overview of historical area of Khiva, with many historical monuments (left), and people living in old, traditional types of houses (right)**



## A New Movement in Chile

Chile has many adobe buildings, but as new industrial materials become available for buildings, adobe has lost its competitiveness because of the high labour costs associated with it. Adobe buildings are vulnerable to earthquakes and have suffered heavy damage, as stated as in Section 3.1. However, some people find historical and cultural value in adobe buildings and have begun to restore them or renovate them and use them in various ways. Some are used

as villas for residents of large cities. Commercial use, such as for hotels and restaurants are also common. They are also utilized for public purposes, such as for post offices. Under this backdrop the Chilean government has an initiative to conserve the historical townscape created by adobe buildings upon reconstruction from the Maule Earthquake, in 2010, by designating historical districts and promoting restoration or renovation of adobe buildings.



Figure 1.3.2 Beautiful townscape provided by adobe houses in Villa Alegre, (left), and a renovated adobe building to be used as a post office in Malloa



Figure 1.3.3 A dining room of a hotel of a renovated adobe building in Malloa (left), and a window that shows the characteristic thick walls of adobe buildings (right)



Figure 1.3.4 Street view of a villa of restored adobe house in Zuniga, (left) and beautiful garden inside (right)



## A Challenge by the Town of Lunahuana, Canete Province in Peru

Lunahuana is a town located around 100 km from Lima, the capital city of Peru, and it attracts tourists from Lima. It has historical buildings and beautiful scenery of mountains and the Canete River. It is a project site of JICA on seismic design of adobe houses (refer to Annex A2.1).

Several model houses were constructed under the project. The mayor of the town felt that this technology would contribute to the cultural and historical charm of the town and decided to construct community buildings, such as a health care center, community centre, etc. by this technology. Besides municipal buildings, some hotels and restaurants of adobe have been constructed by the private sector to attract tourists.

Figure 1.3.5 A symbol of Lunahuana, a church in Lunahuana (left), and a historical building facing the Central Square of Lunahuana (right)



Figure 1.3.6 A community building constructed by the Lunahuana Municipality, which creates a historical townscape



# CHAPTER 2

## EARTHQUAKE RISKS AND PERCEPTIONS BY PEOPLE

### 2.0 Contents and Outline of Chapter 2

Reliable, high-quality risk assessment is the basis for an objective understanding of risk; priority 1 of the Sendai Framework for Disaster Risk Reduction (SFDRR) 2015-2030. It is the foundation of decisions and actions that effectively build resilience. This chapter will guide you

in understanding the basic concepts of seismic risk (2.1); it showcases different seismic-risk assessment approaches, based on various objectives (2.2); and it explains public risk-perception regarding seismic activity and safe houses (2.3).

### 2.1 Understanding Seismic Risks

#### 2.1.1 Basic Concept of Earthquake Risk

##### Three Components of Earthquake Risk Assessment

As shown in Figure. 2.1.1, the risk assessment process consists of three components; hazards, vulnerability and exposure.

Hazards can cause damage to buildings, facilities and people. For example, tsunamis, landslides, liquefaction and ground shaking are categorized as hazards, since they can directly cause

damage to buildings, facilities and people. Vulnerability is an index to measure the capacity of buildings or facilities to withstand each hazard mentioned above. Exposures are items such as buildings, facilities, peoples and so on exposed to the peril given by the hazard.

It is apparent that the earthquake risk is high if either the hazard is high, vulnerability is high or exposure is high. It is therefore very important to know the contribution of each component to the risk, so that effective measures can be taken to avoid or to reduce the risk.

Figure. 2.1.1 Three Components of Risk Assessment

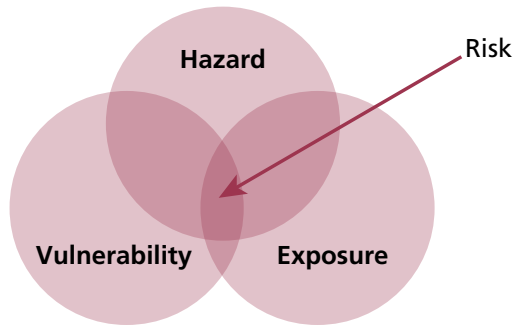

### Risk Management Cycle

In order to reduce risk, the risk management cycle is an effective concept

that consists of 4 steps; risk identification, risk quantification, risk treatment and risk reevaluation, as shown in Figure. 2.1.2.

Figure. 2.1.2 Risk Management Cycle

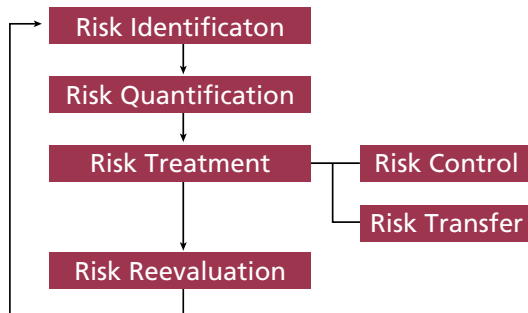

Risk identification is the determining of potential risks to buildings and structures. If a building is located in a river basin, liquefaction as well as ground shaking may be a risk, and if hazardous materials are stored in the building, explosion may be another risk.

Risk quantification is the measuring of the risk by scientific methods and procedures. Since it is quite important to grasp the risk regarding the two aspects; magnitude of loss and probability of occurrence, the risk curve is often used, from which various risk indices are derived, such as

an annual expected loss and probabilistic maximum loss, as shown in Figure 2.1.3. It is apparent that the larger the loss is, the smaller the annual probability of exceedance is, and vice versa.

Risk treatment is action taken to reduce risks. It involves two measures; risk control and risk transfer. The former is to mitigate loss or probability of occurrence by means of relocation, structural-capacity upgrading, or other measures. And the latter is to compensate for losses through some financial approaches, such as insurance, a catastrophe bond,

or others. Risk control is essential but it is limited by technical issues, time and budget. Also, it is very difficult to accurately anticipate a disaster situation so that unexpected loss cannot be avoided. Therefore, it is important to combine risk

control with risk transfer to adequately reflect the results of risk quantification.

Risk reevaluation is the confirming of the adequacy of risk treatment from the viewpoint of risk reduction and its cost.

Figure. 2.1.3 Loss derived from Risk Curve

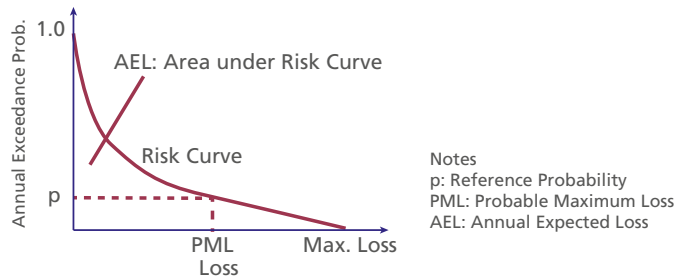

## 2.1.2 Methodologies to Grasp Level of Earthquake Risk

### What will happen in the event of an Earthquake Disaster?

What kind of phenomena will occur? It is useful to employ an event-tree approach to understand all of the

consequences of a hazard from the viewpoint of such phenomenon as shown in Figure 2.1.4, since the function of an urban area has become more complex recently. Figure 2.1.4 shows the typical phenomenon chain from which unnecessary branches can be removed, considering the situation of the area of concern.

Figure. 2.1.4 Sequence of Earthquake Disaster from the Viewpoint of Phenomenon

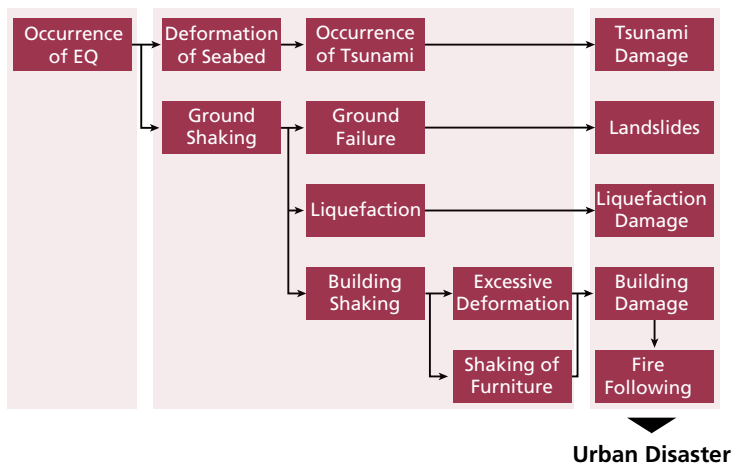

What kind of loss will occur?

It is also useful to grasp the sequence of damage from the viewpoint of loss propagation in order to prepare the necessary budget or to plan for compensation measures and rebuilding

activities after the rescue phase.

The chain of losses is illustrated in Figure 2.1.5, where direct loss and indirect loss are estimated from the risk of relevant items.

Figure. 2.1.5 Sequence of Earthquake Disaster from the Viewpoint of Loss

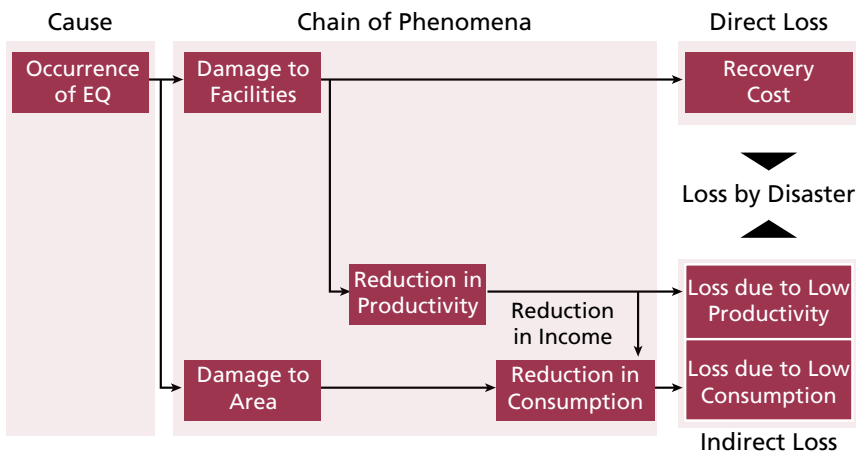

**How do we evaluate earthquake risks?**

Risk quantification employs either a deterministic approach or a probabilistic

one, according to the purpose of risk assessment. The features of each approach are summarized in Table 2.1.1.

Table 2.1.1 General Features of Risk Quantification Approach

	Deterministic Approach	Probabilistic Approach
Purpose	<ul style="list-style-type: none"> <li>Damage anticipation of area for establishing contingency plan / business continuity plan</li> </ul>	<ul style="list-style-type: none"> <li>Determination of seismic design level</li> <li>Loss estimation for insurance (Premier setting)</li> </ul>
Hazard	<ul style="list-style-type: none"> <li>Single event (Scenario earthquake)</li> </ul>	<ul style="list-style-type: none"> <li>Multi events</li> </ul>
Ground motion prediction	<ul style="list-style-type: none"> <li>Precise methodology, such as waveform synthesis method, can be employed.</li> </ul>	<ul style="list-style-type: none"> <li>Empirical method is often used.</li> </ul>
Exposures	<ul style="list-style-type: none"> <li>Building(s)</li> <li>Properties inside/outside of building(s)</li> <li>Infrastructure (water supply, sewage, transportation, etc.)</li> <li>Others</li> </ul>	<ul style="list-style-type: none"> <li>Building(s)</li> <li>Properties inside/outside of building(s)</li> <li>People inside/outside of building(s)</li> <li>Others</li> </ul>

Table 2.1.2 General Method of Risk Quantification

	Deterministic Approach	Probabilistic Approach
Single exposure	Scenario based approach	Employing seismic hazard curve and loss curve
Multiple exposures	Scenario based approach	Multi-events approach that is a weighted sum of scenario based approach

**Deterministic approach**

It is important for governments to anticipate realistic situations for potential disasters in order to create an efficient contingency plan or business continuity plan. For this purpose, a deterministic approach is used, known as the “scenario based approach”.

The deterministic approach is to evaluate the risk under the conditions that the specified earthquake (hereinafter referred to as ‘scenario earthquake’) occurs. Instead of eliminating the information of earthquake occurrence probability, the approach can evaluate not only individual buildings, but also systems that are more

complex, such as groups of buildings, a lifeline system and so on. Moreover, it can employ techniques that are more precise in order to generate ground motion and to evaluate building damage.

It should be noted that the selection of the scenario earthquake is the key issue in the approach. Earthquakes with extremely low probability of occurrence need not be considered. Earthquakes that create little damage to objects of concern also need not be selected. Figure. 2.1.6 illustrates the selection of a scenario earthquake in the Tokyo Metropolis from the viewpoints of effect and probability.

Figure. 2.1.6 Scenario Earthquakes employed for Tokyo Metropolis

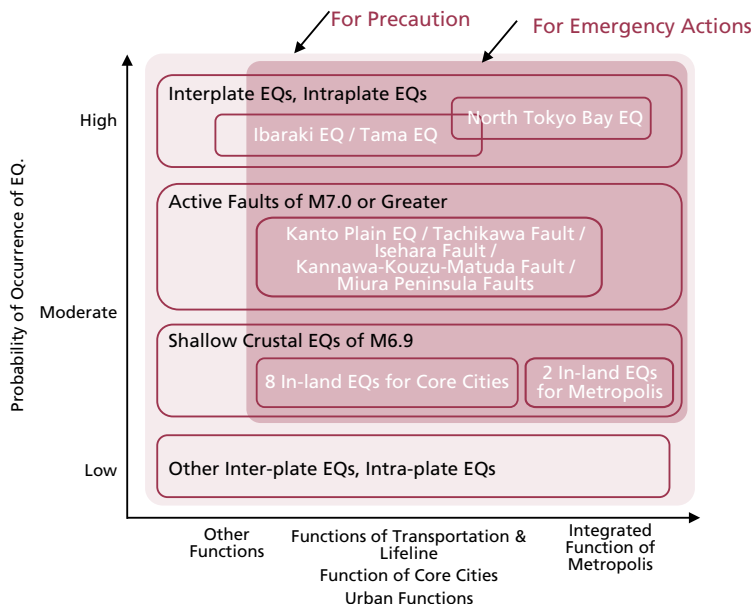

### Probabilistic approach

The probabilistic approach is used to obtain the risk curve mentioned previously for determining insurance premiums, since probabilistic information of loss is essential for insurance companies. Being different from the case of an ordinary fire, a stochastic method (the law of large numbers) cannot be applied to the case of catastrophic disasters due to an insufficient amount of data from past events, so the scientific approach is utilized, through the use of probability distribution functions.

### For single site

The probabilistic approach was developed by the nuclear industry to evaluate an annual occurrence probability of core damage. It has been used in the US since the early 1970s, and is now widely used in the field of insurance. In evaluating a risk of an individual building or multiple buildings on a specified site, a simple procedure, consisting of the seismic-hazard analysis and seismic-fragility analysis is employed. By substituting a loss curve for a seismic fragility curve, a risk curve can be obtained, as shown in the Figure. 2.1.7.

Figure. 2.1.7 Concept of probabilistic approach for single exposure

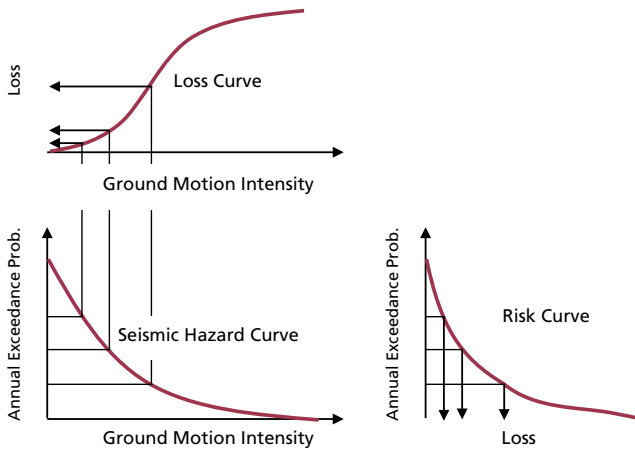

### For multi sites

On the other hand, the above procedure cannot be applied to multiple buildings located on different sites, as one seismic hazard-curve cannot be applicable to more than one building. Currently, the multi-event model is being used to probabilistically evaluate the risk of buildings in the field of financial markets. The concept of the multi-

event model is quite simple, as can be seen in Figure. 2.1.8, where numerous deterministic approaches with probability of occurrence are conducted. Though this method is time consuming, the range of application is quite large, due to its simplicity.



Figure. 2.1.8 Concept of probabilistic approach for multiple exposures

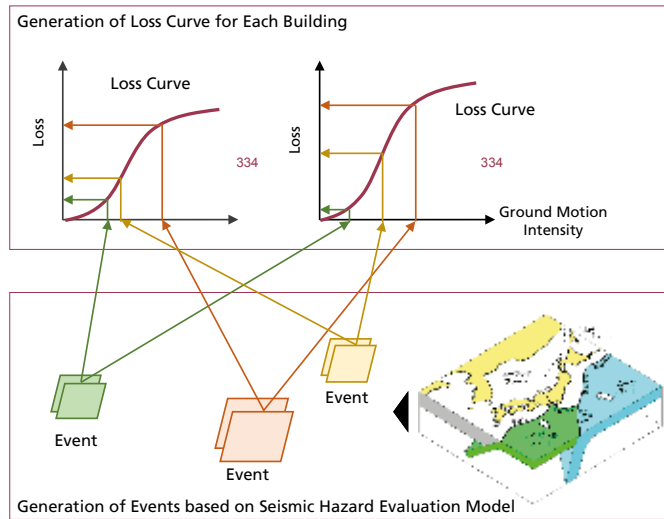

### How do we evaluate ground motion intensity?

In both approaches, deterministic ones and probabilistic ones, it is necessary to assess the ground motion intensity. This section explains how to estimate the ground motion intensity at a given site for

a given scenario-earthquake.

The approach consists of two steps; estimation of ground motion intensity at engineering bed rock and that of amplification of ground motion intensity by surface soil, as shown in Figure. 2.1.9.

Figure. 2.1.9 Two-step Approach to Evaluate Ground Motion Intensity at Surface

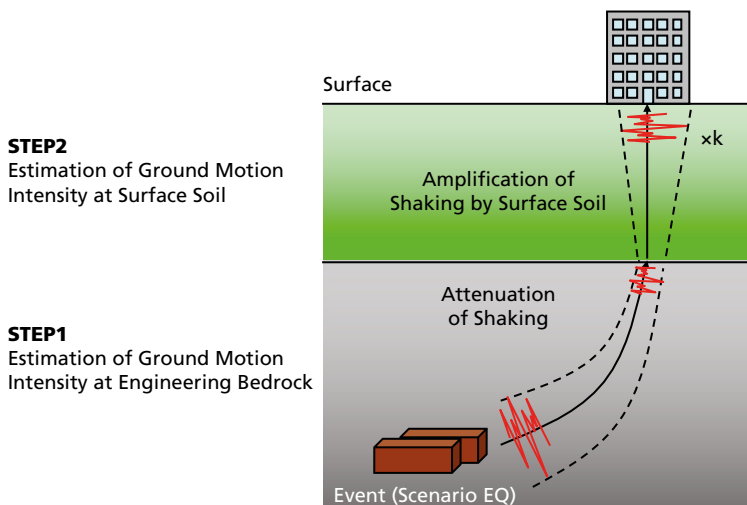

**STEP1****Ground motion intensity at engineering bed rock**

Though the most precise way to express ground motion is by a wave form in the time domain, ground motion intensity is often used to determine the vulnerability of buildings and other facilities.

Ground motion intensity is a representative value that expresses the characteristics of ground motion. In many risk assessments, the peak ground-acceleration, the peak ground velocity and MSK intensity are employed since they are familiar to engineers, as they are used in building design.

It is noted that selecting one index means eliminating other characteristics of ground motion, thus introducing some uncertainty in the evaluation. So it is very important to select an index that is adequate for the building of concern. For example, the peak ground-acceleration and SK intensity

are suitable for buildings with a short natural period, such as low-rise masonry buildings or RC buildings with shear walls, and on the contrary, peak ground velocity is used for buildings with a long natural period, such as steel high-rise buildings or base-isolated buildings. It must be noted the natural period gets longer due to the progress of damage during shaking, so that the peak ground motion may be more adequate even if the building has a short natural period.

*Method1: Empirical method for ordinary earthquake*

In order to estimate ground motion intensity, the empirical formula is often used (the attenuation relation), which evaluates the ground motion intensity as the function of the magnitude of earthquake, focal depth, distance to the site and other parameters. Many attenuation relations have been developed by much research, as summarized in Table 2.1.3.

Table 2.1.3 Example of attenuation relations

Attenuation Formula	Earthquake Type	Parameters Employed
Noda et al. (2002)	<ul style="list-style-type: none"> <li>■ Crustal EQ</li> <li>■ Interplate EQ</li> <li>■ Intraplate EQ</li> </ul>	<ul style="list-style-type: none"> <li>■ Mj: JMA Magnitude</li> <li>■ Xeq: Equivalent focal distance</li> <li>■ Vs: Shear wave velocity at site</li> <li>■ Tsl: Dominant period of ground</li> </ul>
Boore and Atkinson (2007)	<ul style="list-style-type: none"> <li>■ Crustal EQ</li> </ul>	<ul style="list-style-type: none"> <li>■ Mw: Moment Magnitude</li> <li>■ Rjb: Shortest distance to projection of fault</li> <li>■ Vs30: Averaged shear wave velocity at site</li> </ul>
Campbell and Bozorgnia (2007)	<ul style="list-style-type: none"> <li>■ Crustal EQ</li> </ul>	<ul style="list-style-type: none"> <li>■ Mw: Moment Magnitude</li> <li>■ Rup: Shortest distance to fault</li> <li>■ Ztor: Depth of fault</li> <li>■ Z2.5: Depth of layer with Vs=2.5km/s</li> <li>■ Delta: Dip angle</li> <li>■ Vs30: Average shear wave velocity at site</li> </ul>
Uchiyama and Midorikawa (2006)	<ul style="list-style-type: none"> <li>■ Shallow EQ</li> <li>■ Deep EQ</li> </ul>	<ul style="list-style-type: none"> <li>■ Mw: Moment Magnitude</li> <li>■ X: Shortest distance to fault</li> <li>■ D: Focal depth</li> </ul>
Kanno et al. (2006)	<ul style="list-style-type: none"> <li>■ Shallow EQ</li> <li>■ Deep EQ</li> </ul>	<ul style="list-style-type: none"> <li>■ Mw: Moment Magnitude</li> <li>■ X: Shortest distance to fault</li> <li>■ Vs30: Average shear wave velocity at site</li> </ul>
Zhao et al. (2006)	<ul style="list-style-type: none"> <li>■ Crustal EQ</li> <li>■ Interplate EQ</li> <li>■ Intraplate EQ</li> </ul>	<ul style="list-style-type: none"> <li>■ Mw: Moment Magnitude</li> <li>■ X: Shortest distance to fault</li> <li>■ D: Focal depth</li> </ul>

Each attenuation relation was developed by using ground motion observation records, which include the characteristics of ground motion and has limitations in its application. Thus, it is strongly recommended to adjust the attenuation relation by using ground motion observation data, if available. However, if the observation data cannot be obtained, it is necessary to examine the attenuation relations regarding their background of development before conducting risk evaluation.

*Method2: Semi-empirical method and theoretical method for Mega-quake*

For mega-quakes, which means magnitude

8.5 or more, it is difficult to develop an attenuation relation from observation data since sufficient data for regression analysis cannot be collected. As several huge earthquakes have occurred worldwide recently there is a need to estimate the ground motion index for such earthquakes. A semi-empirical method and a theoretical one have been introduced to solve the issue described above.

A semi-empirical method generates ground motion at the site by superposing small earthquakes from small segments (seismic sources) forming a large seismic source. The concept of the semi-empirical method is shown in Figure. 2.1.10.

Figure. 2.1.10 Concept of the semi-empirical method

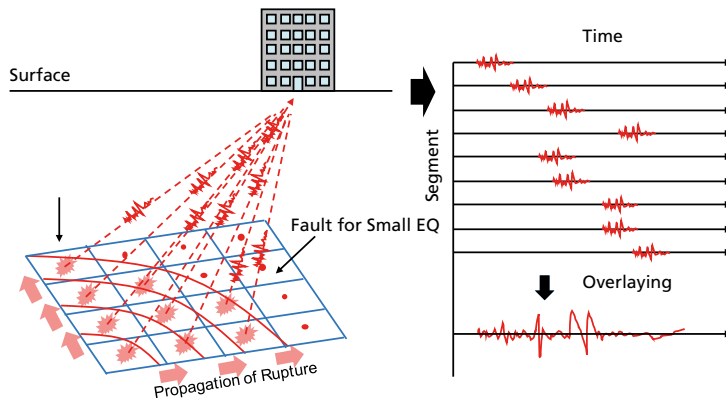

A theoretical method generates ground motion at the site by treating the globe as an elastic body. This method may be employed for design or damage estimation for flexible structures with long period, such as long-span bridges, skyscrapers, and so on.

## STEP2

### Amplification by surface soil

Since ground motion intensities are often estimated at engineering bedrock, as

shown in Figure. 2.1.9, it is necessary to take into account the effect of amplification of ground shaking. For example, mountains and hills, where surface soil is stiff gives low amplification. On the contrary, amplification gets larger in cases of soft soil, such as river basins or alluvial fans.

The intensity of amplification of surface soil is often evaluated using boring data from sites of concern. If no boring data is available, a soil map or categorization of

micro-topography can provide the typical factors for amplification.

### How do we evaluate vulnerability of structures?

Vulnerability of buildings/structures are given as a relationship between ground motion intensity and damage rate, which is a ratio of the number of damaged buildings to the total number of buildings. This section explains the methods to obtain the vulnerability function.

#### *Method1: Literature survey*

Literature survey is the simplest way to estimate vulnerability. Open literature, such as HAZUS, GEM and others provide some vulnerability functions for given types of buildings.

With this method, buildings are often categorized into groups that reflect

certain parameters, such as the age of the construction, structural type and building height. So it is important to make clear the background in selecting the vulnerability function from literature.

#### *Method2: Empirical method*

Empirical method used to obtain the vulnerability function from past-damage data by using regression analysis.

In earthquake prone countries, a lot of damage-related data, such as the number of collapsed buildings, partially damaged ones and ground motion intensities can be collected from past earthquakes. Based on the data, theoretical probability distribution functions, such as normal distribution or log-normal distribution, are estimated as vulnerability functions through the use of regression analysis, as shown in Figure. 2.1.11.

Figure. 2.1.11 Examples of vulnerability functions

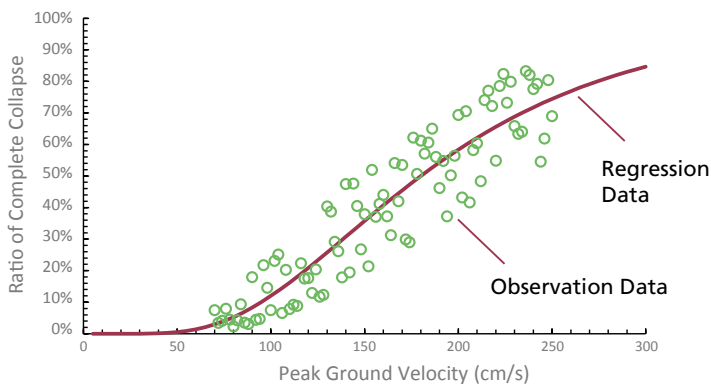

It must be noted that the vulnerability function by the empirical method is earthquake dependent. Therefore, it is important to use ground motion intensity that is insensitive to seismic-source type, such as inter-plate earthquakes, intra-plate earthquakes and crustal earthquakes.

#### *Method3: Theoretical method*

The theoretical method is used in cases when past damage data is not available. The basic concept of the method is regression analysis through the use of simulated-damage data instead of past records.

For special types of structures, such as high-rise buildings, base isolated buildings, large-span structures, and so on, for which damage data cannot be obtained from previous earthquakes,

their vulnerability function must be evaluated using the theoretical method. Figure 2.1.12 illustrates the basic idea for evaluating the vulnerability function in the theoretical approach.

Figure 2.1.12 Theoretical approach to obtain vulnerability

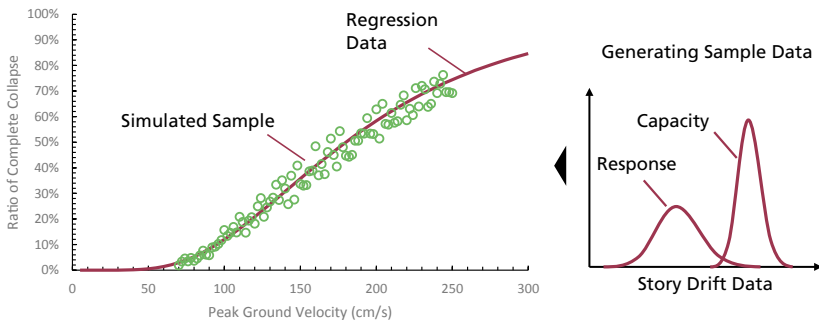

**How do we build up exposure data?**

Exposure means ‘assets that are exposed to risk’. However, it is sometimes difficult to judge which assets are exposed to risk and which are not. Therefore, it is often assumed that all assets have a certain level of exposure. Concretely, these assets include populations, buildings and other structures, equipment and furniture in buildings, and so on.

For example, in Japan, assets are arranged as inventory data for risk

analysis, based on the fixed assets register provided by tax offices. It is noted that developing countries need to make a lot of effort toward this in case further relevant data is required.

**2.1.3 Utilization of Risk Information**

**Summary of Risk Information**

In conducting risk quantification, various products and by-products are obtained, as summarized in Table 2.1.4.

Table 2.1.4 Products obtained in conducting risk quantification

	Products		
User	<ul style="list-style-type: none"> <li>Seismic Hazard Map</li> <li>Seismic Hazard Curve</li> </ul>	<ul style="list-style-type: none"> <li>Vulnerability Functions</li> </ul>	<ul style="list-style-type: none"> <li>Quantified Risk</li> </ul>
Administrators	<ul style="list-style-type: none"> <li>Determination of Location of Shelters and Evacuation Routes</li> <li>Seismic Zonation for Design</li> </ul>	<ul style="list-style-type: none"> <li>Establishing Retrofitting Policy</li> </ul>	<ul style="list-style-type: none"> <li>Establishing Countermeasures</li> <li>Contingency Plan/BCP</li> <li>Stockpiles</li> </ul>
Citizens	<ul style="list-style-type: none"> <li>Awareness of Hazards</li> </ul>		<ul style="list-style-type: none"> <li>Self Defense</li> <li>Community-based Defense</li> </ul>
Enterprises	<ul style="list-style-type: none"> <li>Selection of Sites</li> </ul>	<ul style="list-style-type: none"> <li>Prioritization of Upgrading of Buildings</li> </ul>	<ul style="list-style-type: none"> <li>Establishing Countermeasures</li> <li>Contingency Plan/BCP</li> <li>Stockpiles</li> </ul>

## What products are obtained?

### Seismic Hazard Related

One efficient expression of seismic hazard is known as a seismic hazard map, from which the vulnerable area can be seen.

It is noted that seismic hazard maps are developed for indicating ground shaking

intensity as well as likely locations of landslides and liquefaction. Seismic hazard maps of ground motion intensity for the given return period are used not only for risk assessment but also for determining design earthquake loads on structures in prone countries. An example of hazard maps is shown in Figure. 2.1.13.

Figure. 2.1.13 Example of seismic hazard map by NIED  
(National Research Institute for Earthquake and Disaster Prevention, Japan)

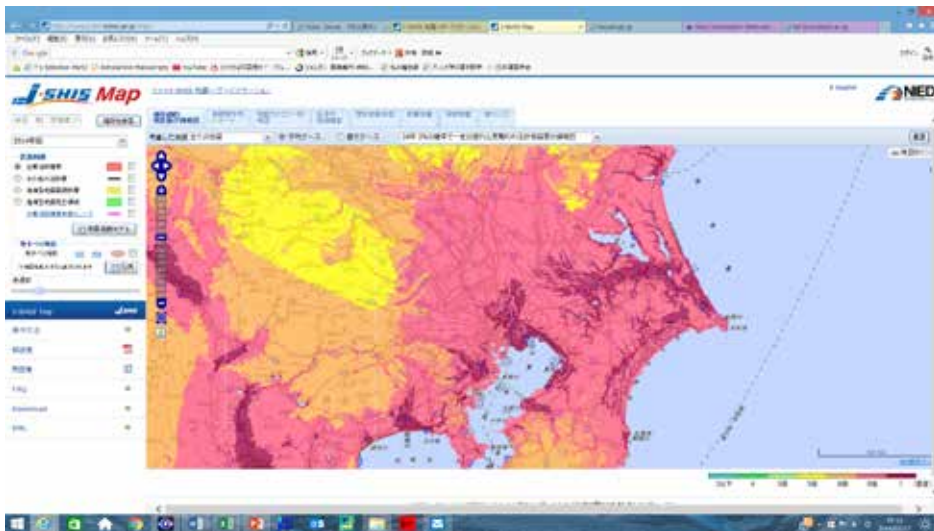

The other expression of seismic hazard is known as a seismic hazard curve, which is a function of ground motion intensity and its annual probability of exceedance.

### Vulnerability Related

Vulnerability function is useful information for evaluating urban damage, since various types of buildings located in a wide area are of concern because a precise methodology cannot be used. It can be noted however, that other functions to determine loss, casualty, business

interruption time, and so on are derived by using the vulnerability function.

### Risk Related

Risk values, such as the number of collapsed buildings, casualties, direct loss, indirect loss, and so on are used as basic information in establishing countermeasures against disasters. Also, data regarding the various losses can be used by the insurance industry for setting deductions, limit values, premiums and others.

## How do we use the information?

### For Administrators

As proactive programs against disasters, administrators can establish effective measures, such as determination of location and amount of stockpiles, location of shelters, evacuation routes. In addition, seismic zonation for design or retrofitting could be considered to be a measure of national importance.

Also, the information is used in preparing documents, such as contingency plans, business continuity plans and disaster response manuals. It is very important to grasp the realistic disaster situation and to plan appropriate actions that recovery actions become achievable.

### For Citizens

Making citizens aware of the likelihood of disasters is the most effective measure to decrease the effects of disasters, since they can act autonomously, which can largely reduce the governmental or sub-governmental burden. It is also necessary for citizens to act autonomously in case that government assistance cannot be obtained.

As an individual or family, people can take concrete actions, such as putting devices on furniture to prevent overturning, establishing an evacuation route, and so on. And as a community member, community-based actions, for example holding emergency drills or preparing stockpiles of food, water and other necessary items, can be conducted.

### For Enterprises

Based on seismic hazard information, the location of buildings and other facilities can be examined to reduce losses due to disasters. Also, vulnerability information can be used to prioritize the order of retrofitting activities or of rebuilding. Evaluated losses, such as annual expected loss and the likely maximum loss, are used as risk-transferring measures.

Risk related information is also used in preparing a contingency plan, a business continuity plan and disaster response manuals for administrators, as mentioned previously.

## 2.2 Risk Assessment Approaches for Countries with Limited Data

Data availability is critical for risk assessment. However, in many countries, historical disaster-records are not kept, and other necessary geographical data as well as data on existing infrastructure are scarce. This section introduces two different approaches to quantify risks in countries with limited data: a detailed survey and data generation (2.2.1); an open-source application and geospatial technologies (2.2.2).

### 2.2.1 Seismic Risk Mitigation Planning in Istanbul: Data Generation and Seismic Micro Zonation by JICA

“The Study on a Disaster Prevention/Mitigation Basic Plan in Istanbul”

This section introduces the application of a risk quantifying method, as explained in section 2.1 for Istanbul, Turkey.

#### Purpose

The study was conducted to prepare a seismic-risk mitigation plan, particularly to estimate the level of damage to buildings, people and infrastructures based on possible earthquake scenarios. To quantify risk and compare those risks among districts, it employed the micro zonation method. The risk was quantified based on GIS based data, such as ground motion intensity, building census and vulnerability, then overlaid with other data, such as population, road network, and so on.

Figure. 2.2.1 Features of Deterministic Risk Quantification Approach in the Project

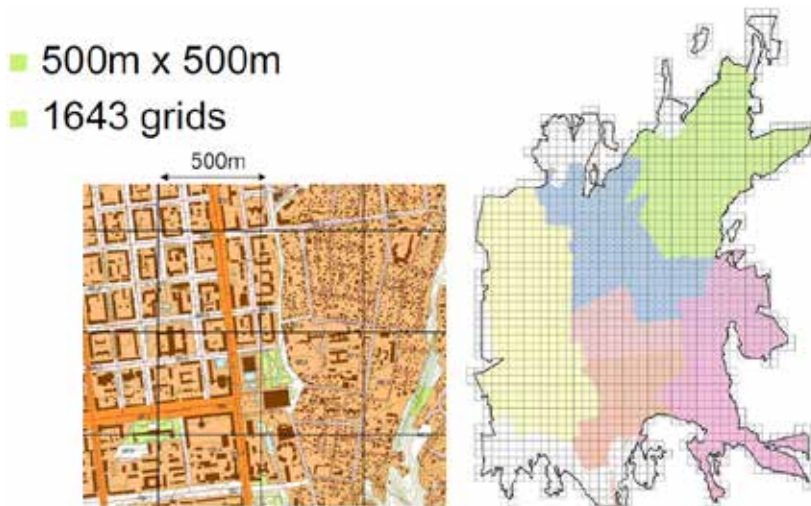



### Hazards

#### Scenario Earthquakes

Since several rupture patterns can be considered, four scenario-earthquake models were made based on the submarine faults, as shown in Figure 2.2.2, considering historical

seismic motion and patterns. Important elements used for scenario-earthquake models are geographical location and shapes of major faults, damaged condition of major faults in past seismic activities, and a mechanism analysis of small earthquakes along major faults.

Figure. 2.2.2 Fault Models of Scenario Earthquakes

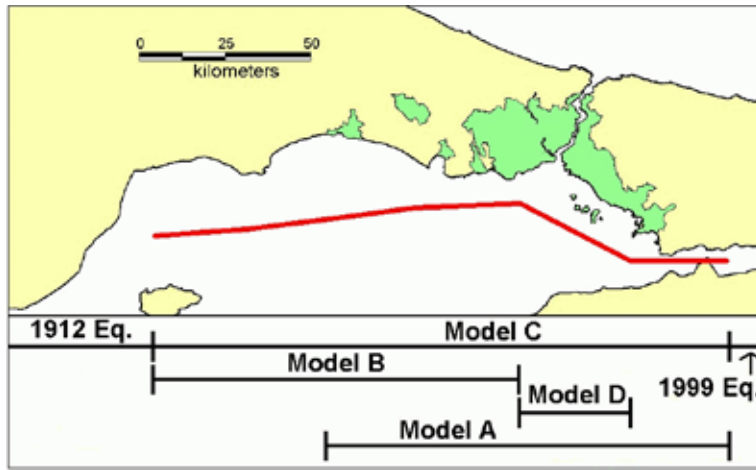

Table 2.2.1 Fault Parameters

	Model A	Model B	Model C	Model D
Fault Length (km)	119	108	174	37
Magnitude	7.5	7.4	7.7	6.9
Type	Strike-slip	Strike-slip	Strike-slip	Normal fault

#### Ground motion prediction

**Ground Motion at Engineering Bedrock**  
As illustrated in the previous section (See, Figure 2.1.9), ground motion intensities at engineering bedrock were evaluated by using the attenuation formula, as selected through analysis that was based on observed seismic records in Istanbul during the Kocaeli earthquake. In this evaluation, the depth of the engineering bedrock was set where shear wave velocity is 850m/s.

#### Ground Motion at Surface

Ground motion intensities at the surface were evaluated by multiplying intensities at engineering bedrock by the amplification factor, which was quantified for each micro zonation by using the average S-wave velocity over 30m from ground surface as a parameter. The distribution of the average S-wave velocity is shown in Figure. 2.2.3. Figure 2.2.4 shows the distribution of PGA (peak ground acceleration).

Figure. 2.2.3 Ground Classification by Average S-wave Velocity

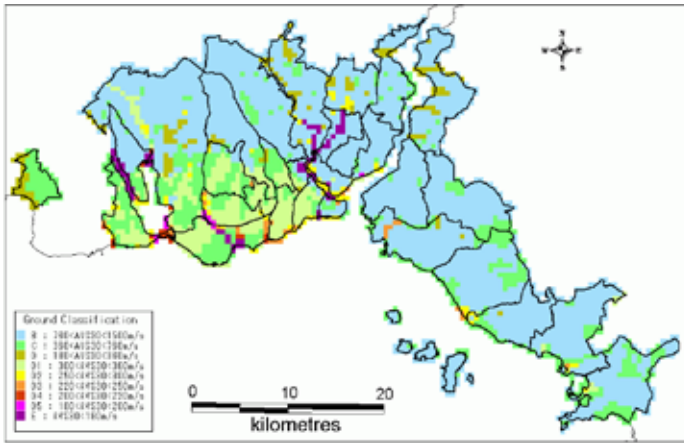
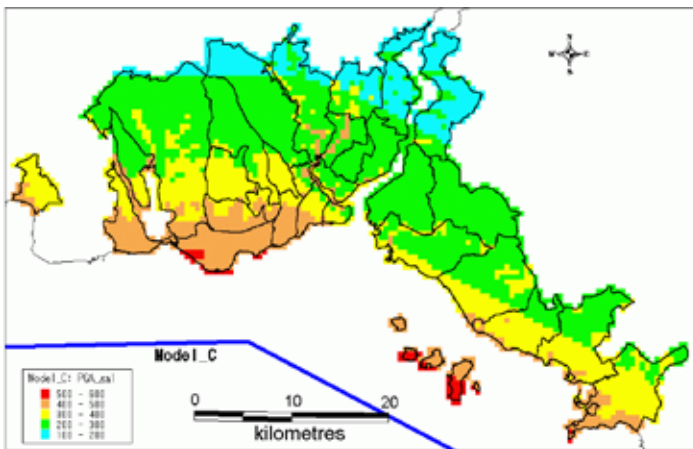

Figure. 2.2.4 PGA Distribution



**Exposures**

**Buildings**

*Developing Building Inventory*

The 2,000 Building Census was used to make a building inventory database as a

foundation to assess building damage. As Figure. 2.2.5 shows, the major structure type, which accounted for 75% was classified as "RC Frame with Brick Wall".

Figure. 2.2.5 Percentages of Structural Type of Buildings in Istanbul

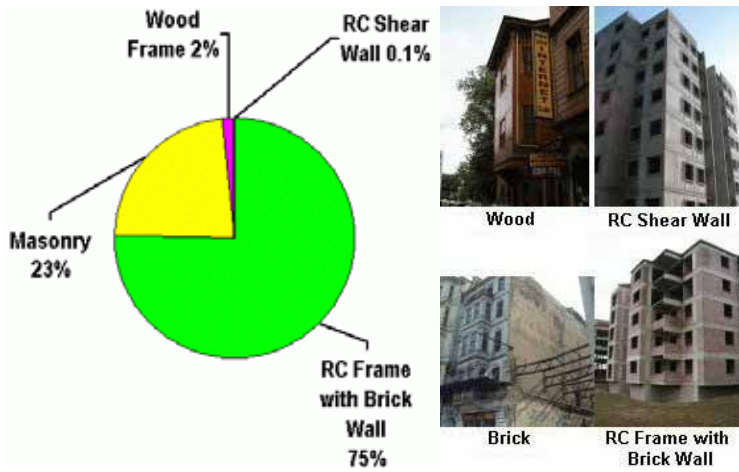

#### *Vulnerability Functions*

To evaluate the building vulnerability function for each class stated in the Turkish census, building damage analysis was conducted using the Capacity Spectrum method. The feature of the method is that it include important effects due to inelastic behavior. For example, if buildings oscillate beyond the elastic range, the natural period gets longer by

cracking in columns and beams and by damage to shear walls, and so on. Also, structural damping becomes greater due to hysteresis of structural members.

#### *Estimation of Damage*

The number of buildings damaged is calculated for scenario earthquakes Model A and C. Figure. 2.2.6 shows the number of heavily damaged buildings in each administrative division for Model C.

Figure. 2.2.6 Number of Heavily Damaged Buildings by Model C

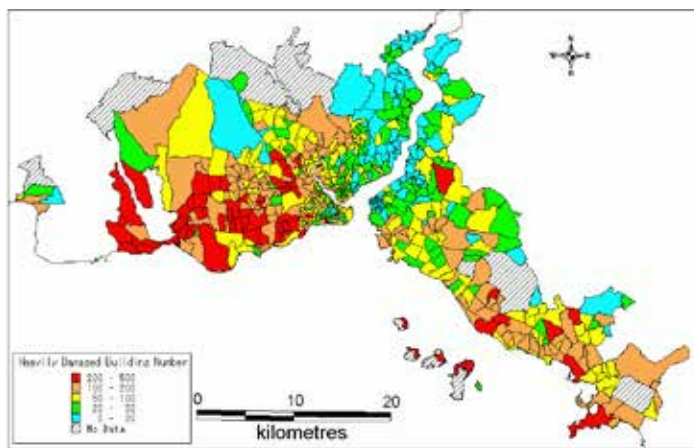

## Casualties

### Damage Functions

To grasp the amount of estimated casualties and geographical distribution, the potential death toll was estimated using the damage function, which is

shown in Figure. 2.2.7. The damage function is the relationship between the number of heavily damaged buildings and the number of fatally injured people, which is obtained by regression analysis by using data from past disasters.

**Figure. 2.2.7 Empirical Relation of Building Damage and Death Toll in Turkey**

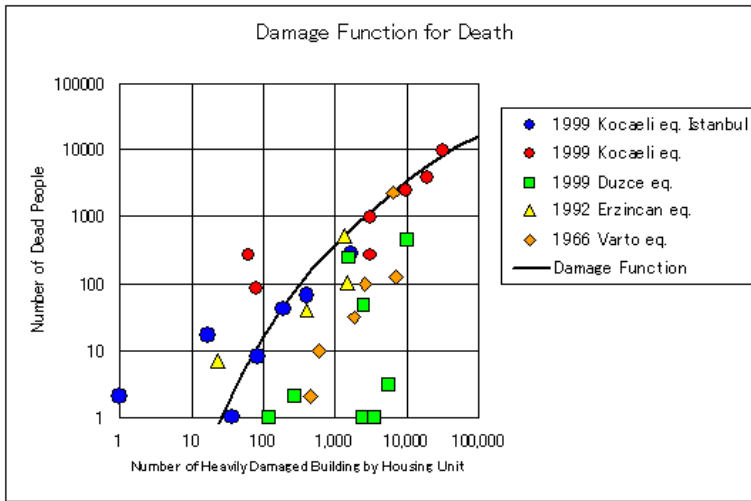

### Estimated Damage

The death toll was estimated to be 87,000, and the estimated number of severely injured people was 135,000. These figures were duly reflected in the disaster management plan by JICA.

### Urban Infrastructures

As urban infrastructures, risk on a road network and for bridges were analyzed (Figure. 2.2.8), and priorities for bridge reinforcement were identified, as shown in Figure 2.2.9. Potential areas of isolation due to road blockage were identified (Figure 2.2.10).

Figure. 2.2.8. Flowchart of Risk Quantification both for Road Networks and for Bridges

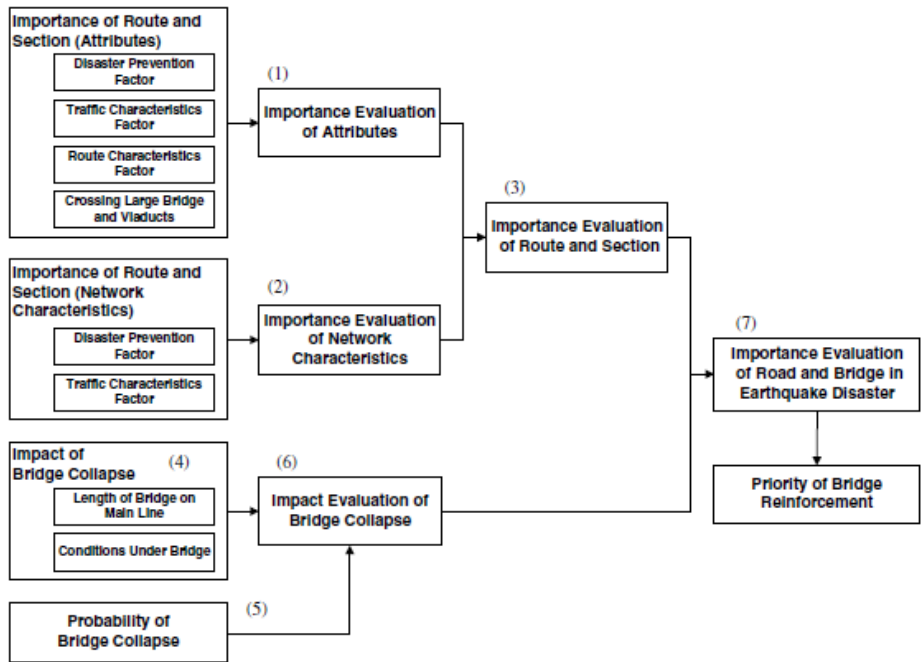

Figure. 2.2.9. Priority of Bridge Reinforcement

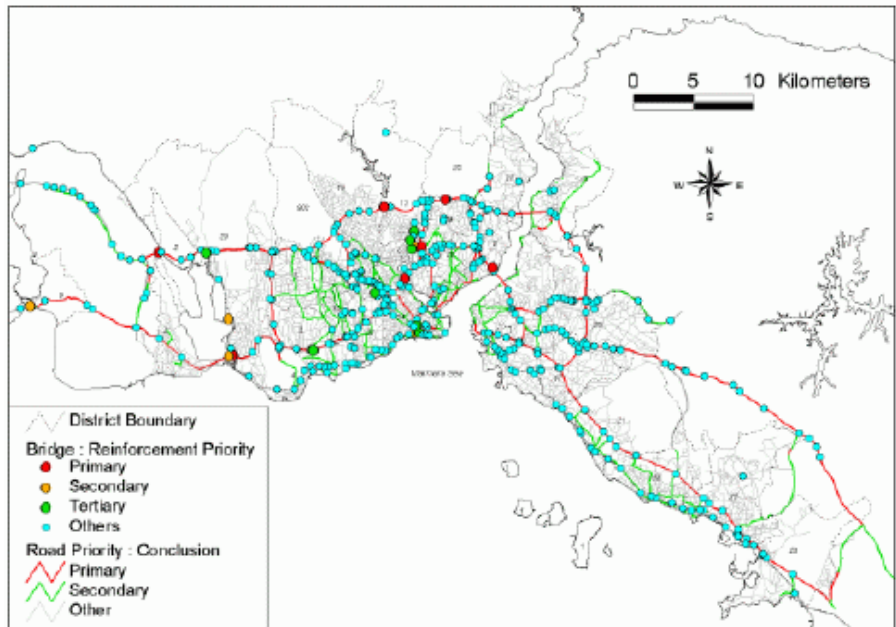
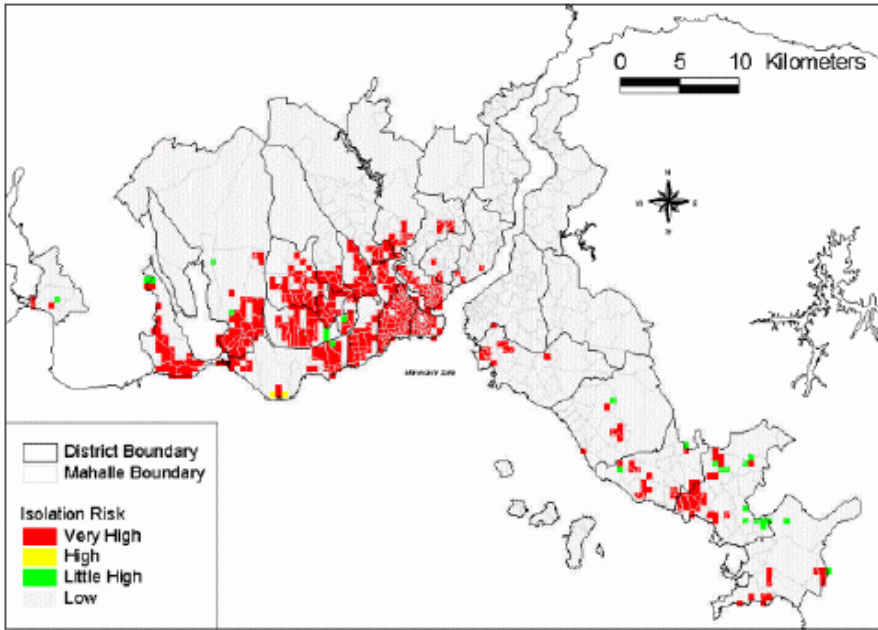

Figure. 2.2.10. Distribution of Isolation Risk by Road Blockage



Lifelines

In the study, the damage estimation of

lifelines (water, sewage, gas, electricity and telecommunications) was assessed.

Figure 2.2.11 Distribution of Gas Pipe Damage

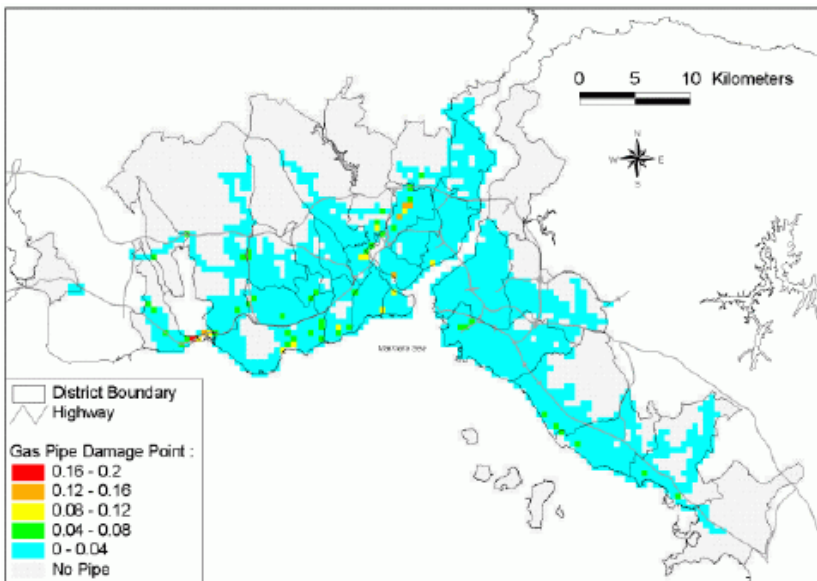

## Conclusions

In order to develop a detailed disaster management plan for Istanbul, the micro- zonation-based method was employed because of its high resorted risk evaluation. Relevant data collection and development are essential to conduct this level of detailed risk assessment. When you conduct a risk assessment, it is paramount to have clear objectives and to employ appropriate methods to achieve them.

## 2.2.2 Global Earthquake Model (GEM) – Working together to Assess Risk

### What GEM does

Earthquake risk continues to rise, yet reliable data, risk information and assessment tools are out of reach or underutilized in many areas of the world. *The Global Earthquake Model (GEM Foundation)* was created to bridge these critical gaps.

The GEM Foundation is a public-private partnership that drives a global collaborative effort in which science is applied to develop high-quality resources for transparent assessment of earthquake risk and to facilitate their application for risk management around the globe. The GEM community supports risk management and awareness by developing and implementing open risk-assessment tools, compiling and generating risk information. GEM influences risk reduction by promoting technology transfer and developing risk-assessment capacity. More than 350 leading experts have already worked under GEM's umbrella on the development of global data sets, tools and methodologies that GEM makes readily available at no charge, through its web-based *OpenQuake Platform*. The application of these tools and methodologies rely heavily on the integration of local experts to properly reflect local conditions and needs and effectively incorporate local knowledge.

Figure. 2.2.12 GEM Core functions

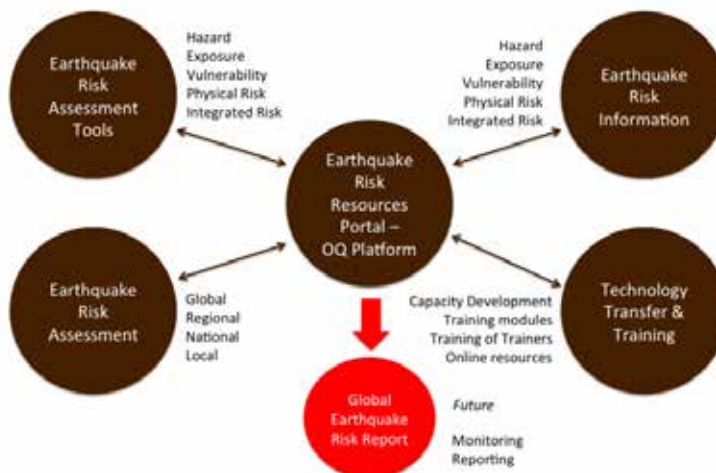

## An integrated assessment of earthquake risk

GEM promotes an integrated understanding of earthquake risk. GEM's scientific framework starts with a comprehensive understanding of the probability of ground shaking due to earthquakes by analyzing all of the components of the hazard assessment. Then, physical risk is assessed by modeling its subcomponents' exposure and fragility/vulnerability, and combining

them with the assessed hazard. But real risk is much more than physical risk: the preparedness and capacity of a community to withstand the impact of catastrophic events, such as earthquakes, is an important element that influences its final impact. This element is addressed by defining indicators of social vulnerability and resilience, and the methodologies used to define them. These indicators are then combined with physical risk, resulting in a holistic view of earthquake risk, called "Integrated Risk".

Figure. 2.2.13. a) Physical risk and b) Integrated risk assessment for Ecuador

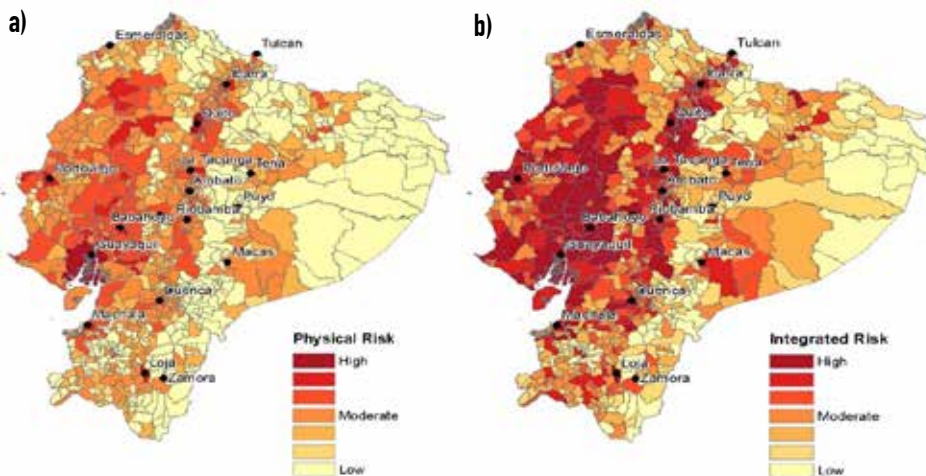

## The OpenQuake Platform

The GEM Foundation has created the OpenQuake Platform, an integrated computational platform for earthquake risk assessment. This platform is comprised of a number of components: the OpenQuake computational engine; more than a dozen global databases and models; hazard- and risk results, from a regional- to a national scale, generated by GEM and its partners; and a suite of users' tools, called the Modeler's Toolkit. Officially launched in January 2015, the platform is openly

accessible and free to all users. It allows any user free access to a number of datasets, models and tools for 1) developing a hazard or risk model, 2) analyzing risk, and 3) interpreting/understanding risk analysis results. Cases for hazard and risk include scenarios and probabilities (classical and event-based). OpenQuake can be used for single-asset/site calculations, through to complex portfolios on national-, regional- and global scales.

Capacity development and technology transfer are at the core of GEM's activities.



Besides regular training provided at its headquarters in Italy (two training sessions per year, one on hazards and one on risk, regularly attended by about twenty scientists, engineers and industry

experts from all over the world). GEM has an active calendar of training workshops to disseminate the use of software and models developed by the GEM community.

Figure 2.2.14. GEM workshop (left), GEM group picture (right)



*Capacity development and technology transfer are at the core of GEM's activities*

### Harmonized understanding of earthquake risk around the world

GEM has a global mandate to reach global coverage. To do so, GEM works together with regional initiatives to develop new hazard- and risk models, and it leverages an existing regional/national scale seismic hazard studies that are either open or are

made available to GEM. Through this work, GEM is creating a growing repository of models, data, information and knowledge in standardized formats that facilitate comparison, integration and information sharing. Currently, GEM is working on 17 regions of the planet and expects to complete full global coverage by 2018.

Figure. 2.2.15. Working towards global coverage

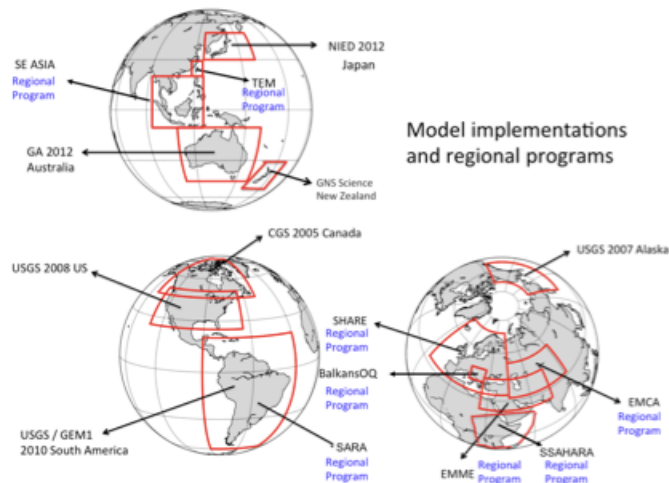

### A collaborative, impact-oriented approach

To promote sustainability, GEM's work includes two major areas: capacity development and institutional strengthening, and stakeholder engagement.

Capacity development and institutional strengthening activities include the establishment of partnerships and networks at regional-, national-, and international levels, the installation of risk assessment capabilities in relevant public organizations, the incorporation of risk assessment courses in academic institutions, and the systematic implementation of technology transfer

mechanisms. Considering that data, information and knowledge are useful only when they are available to their potential users, GEM makes efforts to ensure that all of the compiled information, as well as newly generated results and knowledge, are readily available to everybody who might need or use them.

GEM engages end-users from the very beginning to ensure that its work properly reflects the local conditions and responds to the needs of the local communities. Fostering local ownership is considered crucial in facilitating adaptation, use and application of the risk assessment results. This is especially true at the local level, where actual disaster-risk reduction actions are implemented.

Figure 2.2.16. GEM workshop in Lalitpur, Nepal



Agreeing on local needs, priorities and goals in Lalitpur, Nepal

### Sendai Framework for DRR – meaning for GEM

In March 2015, in the Japanese city of Sendai, 187 countries signed the Sendai Framework for Disaster Risk Reduction (SFDRR) 2015-2030, and committed to work on four priorities. Priority 1 is Understanding Disaster Risk: “*The need for improved understanding of disaster risk in all its dimensions of exposure, vulnerability and hazard characteristics*”

GEM’s role in supporting the successful implementation of the SFDRR 2015-2030 includes, at least, the following key activities:

- Increase understanding of earthquake risk
- Facilitate incorporation of risk information in decision making
- Monitor and report status of earthquake risk around the world
- Provide necessary information to support priorities 2, 3 and 4 of the SFDRR.

#### Box Story: Case of Tokyo: Seismic Risk Assessment for Community Use “Community Earthquake Risk Assessment”

The Tokyo Metropolitan Government utilizes scientific risk-assessment results not only on a basis of resilient urban-development planning, but also for awareness-raising in communities throughout the metropolitan area . This story highlights the benefits of scientific risk-assessment and an approach to foster self-help capacities of the residents.

#### Background

Since the first assessment results were announced in 1975, the Tokyo Metropolitan Government has been updating seismic-risk assessment regularly. The most recent assessment, in 2013, examined the vulnerability of buildings and fire hazards in 5,133 localities in Tokyo. This study was conducted under the guidance of the Community Risk Assessment Committee, consisting of disaster management experts from government agencies, and academic societies.

#### Objective

There is a 70 percent chance that Tokyo and the greater Kanto region will be hit by a massive earthquake with a magnitude of about 7 within the next 30 years. Therefore, it is essential for communities to understand scientific-assessment results, which can help communities prepare for the next earthquake. Updating risk-assessment results, in accordance with the most recent urban development, is essential to continue urban (re) redevelopment to improve resilience in cities like Tokyo, where urbanization never stops.

This assessment result shows the vulnerability level of each locality on a scale from 1 (low) to 5 (high). The assessment analyzed both the vulnerability of buildings (years of construction, structural types and numbers of stories) and emergency response difficulty (access to the site, availability of required infrastructure for emergency occasions, etc.) in every locality.

Figure 2.2.17. Flow of Community Earthquake-Risk Assessment

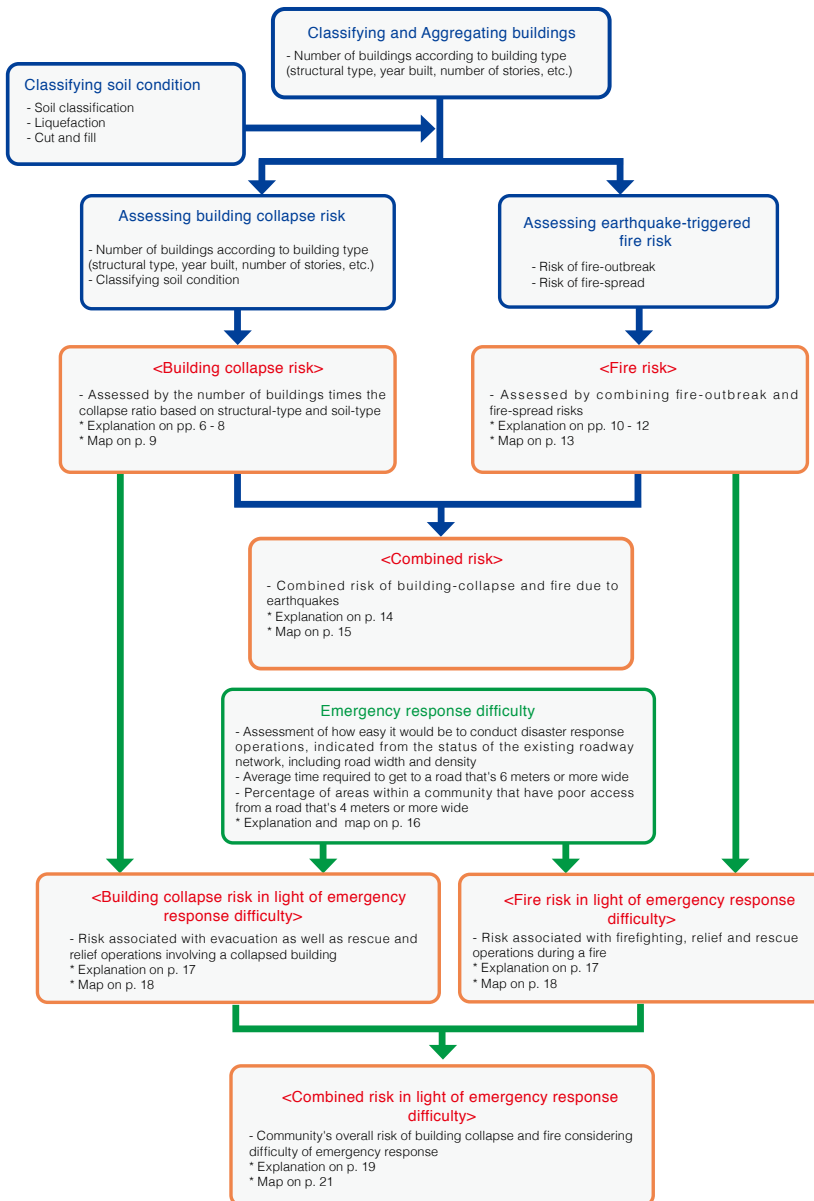

**Methodology**

As you see in Figure 2.2.b.1, this assessment utilizes the following three major inputs, and rates risks based on combined risks.

- Classification of Soil Conditions (soil classification, liquefaction risk, cut-and-fill conditions)

- Building Collapse Risks (structural types, year of construction, number of stories, etc.)
  - Fire Risks triggered by earthquakes (fire-outbreak risk, fire-spread risk)

This utilizes a deterministic approach that applies the same level of intensity to the entire area in order to identify the most vulnerable area of areas with the same conditions. This is different from a scenario-based approach, which shows vulnerable areas under a specific earthquake scenario.

### Use of the Results

The results summary and detailed results for each ward can be accessed online by the public. The results are not only used by metropolitan governments and ward offices, but they also help communities to understand risks in their own communities and know evacuation points in their neighborhoods.

Link to Tokyo Metropolitan Government's Community Earthquake Risk Assessment:  
[http://www.toshiseibi.metro.tokyo.jp/bosai/chousa\\_6/download/kikendo.pdf?1309](http://www.toshiseibi.metro.tokyo.jp/bosai/chousa_6/download/kikendo.pdf?1309)  
[http://www.toshiseibi.metro.tokyo.jp/bosai/chousa\\_6/chiikikiken.htm](http://www.toshiseibi.metro.tokyo.jp/bosai/chousa_6/chiikikiken.htm)

## 2.3 Public Perception of Seismic Risks

### Survey of Public Perception of Seismic Risk in Eight Countries

#### Objective: to understand risk perception

An unfortunate fact about earthquake damage to non-engineered housing is that people are often killed due to the failure of housing that they themselves constructed. It is essential to make housing safer against future risks in order to reduce human casualties and asset damages and losses. Non-engineered housing can be more resilient to strong tremors with the use of appropriate engineering knowledge and construction practices. A big challenge, however, is the lack of motivation and capacity of stakeholders to invest in strengthening non-engineered housing. The initial step to decide the

area of priority investment for resilience is understanding risks from different perspectives, per stakeholder group. The survey results will propose different intervention approaches per stakeholder group to help bring about behavioral changes for the strengthening of non-engineered housing against earthquakes, based on the current risk perception.

#### Survey method and partners

A survey was conducted in 2007 and 2008 in seven countries in partnership with local partners in each country, utilizing a standardized questionnaire (Figure 2.3.1). The survey targets were categorized into three groups: residents, builders/masons, and government officials.

Figure. 2.3.1. Questionnaire

Attributes of the respondents	Risk perception and behaviour of the respondents
<ul style="list-style-type: none"> <li>▪ Q3. Sex</li> <li>▪ Q4. Age</li> <li>▪ Q5-1. Family members living together: Total number</li> <li>▪ Q5-2. Family members living together: Number of members ← age 15</li> <li>▪ Q5-3. Family members living together: Number of members → age 60</li> <li>▪ Q6a. House: How long have you been living in this house?</li> <li>▪ Q6b. House: Ownership</li> <li>▪ Q6c. House: Floor area</li> <li>▪ Q6d. House: Type of house</li> <li>▪ Q6e. House: Major structure</li> <li>▪ Q6f-1. Cost of house in local currency: Purchase</li> <li>▪ Q6f-2. Cost of house in local currency: Self-built (total cost)</li> <li>▪ Q6f-3. Cost of house in local currency: Rent (per month)</li> <li>▪ Q7. Have you ever experienced any disasters? If yes, what kind(s) of disaster(s) you have experienced? [Multiple answers]</li> <li>▪ Q13. Who built your house?</li> <li>▪ Q30. Are any community based associations or organizations working for disaster risk reduction in this area?</li> <li>▪ Q33. What is your academic qualification?</li> <li>▪ Q34. What is your occupation?</li> <li>▪ Q35. How much is your monthly household income (approx.)?</li> </ul>	<ul style="list-style-type: none"> <li>▪ Q8. What do you think will most severely affect your life?</li> <li>▪ Q9. What kind of disaster do you think will most affect your life?</li> <li>▪ Q10. Do you think a big earthquake will occur in the area where you live in the future?</li> <li>▪ Q11. What kinds of impacts do you anticipate due to a big earthquake? [Multiple answers]</li> <li>▪ Q12. What have you done to reduce the impacts of earthquakes? [Multiple answers]</li> <li>▪ Q14. Do you think your house is strong enough to withstand a big earthquake?</li> <li>▪ Q14a. [if answered 'No' in Q14] Do you plan to make your house safer? (Or do you plan to move due to the unsafe house?)</li> <li>▪ Q14b. [if answered 'No' in Q14a] Are you worried about the collapse of your house due to earthquakes?</li> <li>▪ Q15. Whom do you rely on for a safer house?</li> <li>▪ Q16. If your house collapses and kills some of your family due to a big earthquake, who would you blame?</li> <li>▪ Q17. If your house would be severely damaged by an earthquake, what would be the causes for the weakness of the house?</li> <li>▪ Q18. Are you concerned if your neighbours' houses are highly vulnerable?</li> <li>▪ Q19. Do you think information on the seismic risk of houses in the neighbourhood should be shared among people?</li> <li>▪ Q20. Do you have any knowledge about the available techniques for strengthening houses against earthquakes?</li> <li>▪ Q21. How costly do you think is it to protect your house from earthquakes?</li> <li>▪ Q22. [only to house owners] How much could you spend to protect your house/property from a big earthquake?</li> <li>▪ Q23. [only to house owners] How much could you spend to protect your family members from a big earthquake?</li> <li>▪ Q24. [only to house owners] What is your plan for a safer home?</li> <li>▪ Q25. [only to house owners] What kinds of support would make you decide to invest for strengthening or retrofitting your house?</li> <li>▪ Q26. [only to house renters] How much of an increase in your rental fee could you accept to protect your house/property from a big earthquake?</li> <li>▪ Q27. [only to house renters] How much of an increase in your rental fee could you accept to protect your family members from a big earthquake?</li> <li>▪ Q28. [only to house renters] What is your plan for a safer home?</li> <li>▪ Q29. What facilities do you think should be protected with high priority? [Choice of three answers]</li> <li>▪ Q31. Have you ever participated in any initiatives/activities for disaster risk reduction?</li> <li>▪ Q32. How long do you plan to live in this house?</li> </ul>

### Residents' risk perception

Approximately 400 households in non-engineered housing were randomly selected in each community.

#### Future risk that may affect life

*Questions:*

- "What do you think will most severely affect your life?"
- "What kind of disaster do you think will likely most affect your life?"

The results show that disaster is not necessarily the dominant risk that residents fear. The residents' risk-perception could be influenced by recent disasters or accidents to them at the time of survey. However, most people in four countries surveyed were afraid of disasters, and earthquakes were the most feared type of disaster.

Figure 2.3.2. Perception of the Worst Possible Risk

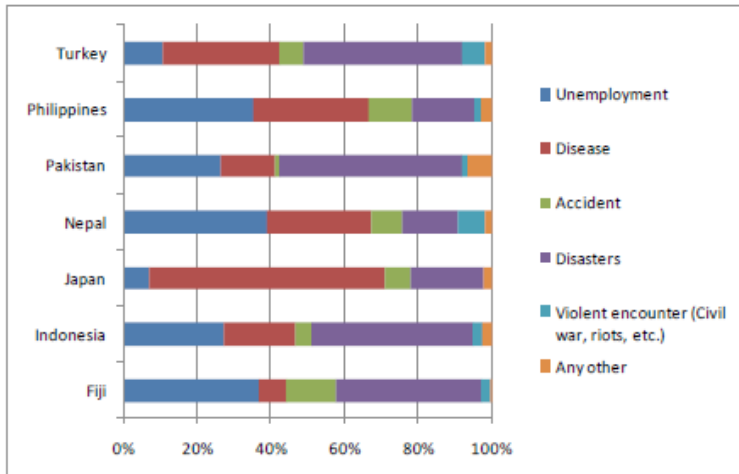
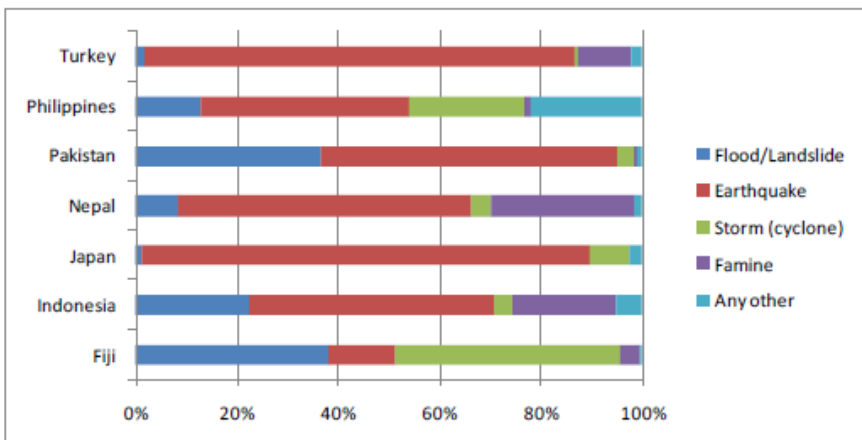

Figure 2.3.3. Perception of the Worst Possible Natural Disaster Risk



### Safety of housing

*Question:*

- “Do you think your house/apartment, etc. is strong enough to withstand a big earthquake?”
- “What have you done to reduce the impacts of earthquakes?”

The results show that risk perception of their own houses varies according to country, and the countermeasures that residents took also varies from country to country. While around 40% haven’t taken actions in Pakistan and Nepal, more than 80% of residents took different kinds of actions in other countries.

**Figure 2.3.4. Belief in structural robustness of own housing against seismic risks**

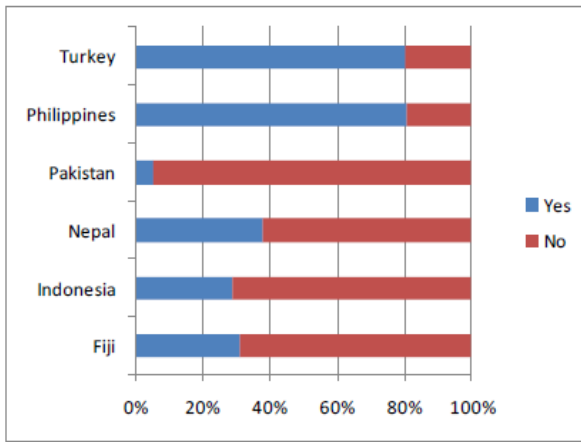

**Figure. 2.3.5. Actions taken by homeowners to reduce risks (multiple answers)**

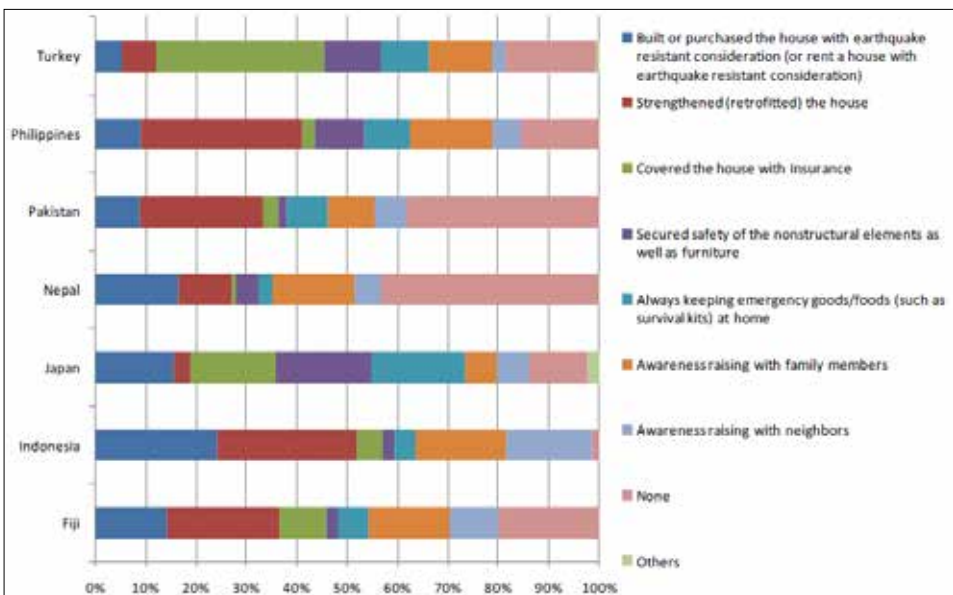



### Responsibility for housing safety

*Question:*

- “Whom do you rely on for a safer house?”
- “If your house collapsed due to a big earthquake and killed some of your family, who would you blame?”
- “If your house were severely damaged by an earthquake, what would be the causes for it not being able to withstand the earthquake?”

The results showed that the majority relied on “engineers” for safety of houses, while people in the Philippines and Fiji relied on “family/neighbors/friends”, and in Pakistan, on masons or the government. It is interesting that these results do not necessarily correlate to the results of the second question, regarding who to blame for structural failure in disasters. The results of the third question also don’t correlate to engineers’ roles as the main cause of housing damages.

**Figure 2.3.6. Responsible person for the safety of a house**

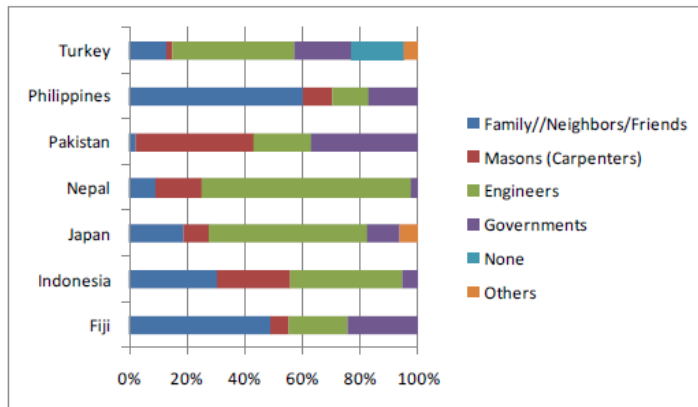

**Figure 2.3.7. Who is at fault in the case of housing collapse due to earthquake?**

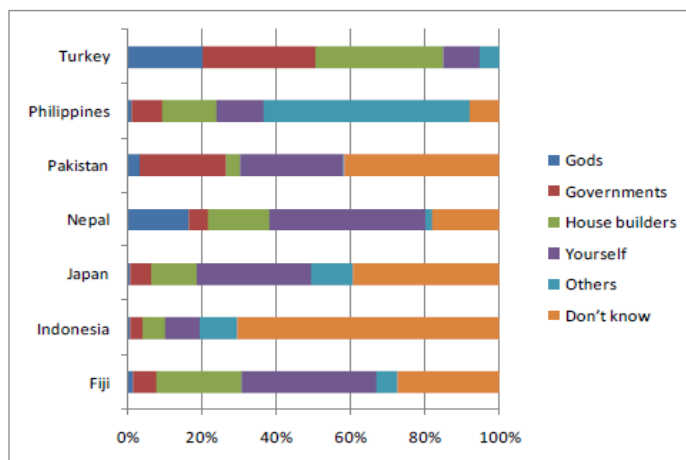
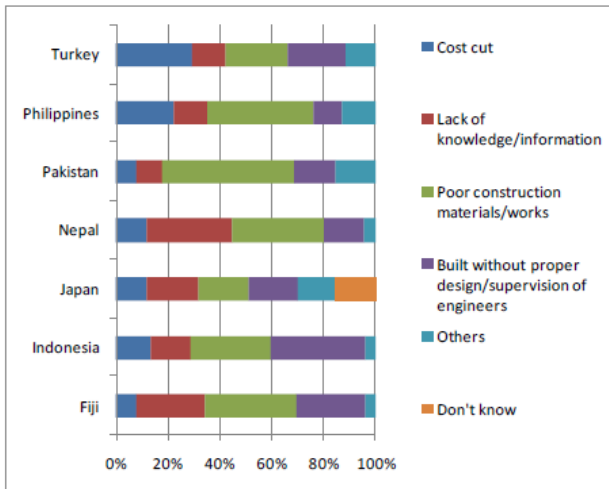

Figure 2.3.8. Reason for potential damages from earthquakes



**Survey targeted Builders and Masons**

A targeted survey on house builders and head masons was conducted to understand the risk perception of those who construct conventional houses. Approximately 50 house builders or head masons were interviewed.

**Safety of the house**

*Question:*

- “How do you think a big earthquake could affect the houses you constructed?”

- “Do you know the details of the building code and / or housing guidelines developed by the government?”

The results of the first question show the confidence of masons and builders on the quality of houses that they built, while the results of the third question show that most of them do not apply building codes or adhere to any guidelines in their construction practices.

Figure. 2.3.9. Perception of potential damage from earthquakes

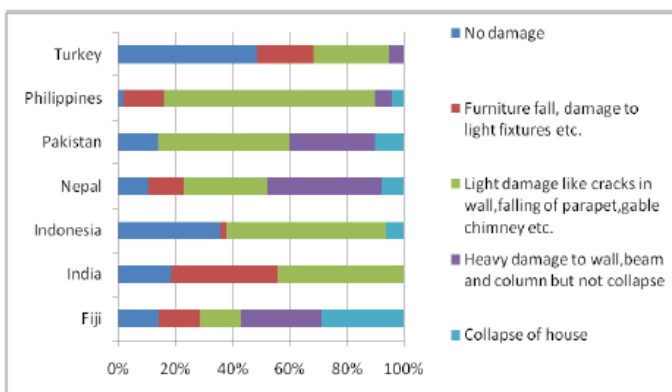
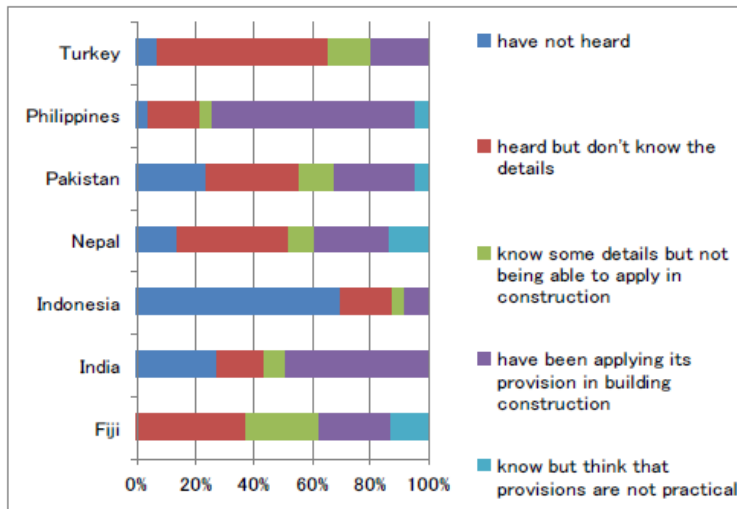

Figure. 2.3.10. Workers' knowledge level of building code and technical guidelines provided by governments



### Survey targeted Local Government Officials

The targeted local government officers were those responsible for disaster risk management or safer building construction in local municipalities. Approximately 30 local government officers were targeted in each country.

#### Responsibility for housing safety

##### Question:

- "Who do you think should be considered most responsible for damage to buildings and loss of lives due to earthquakes?"
- "Which stakeholders or members/ group can contribute most towards improvement of building safety in your city?"

To the first question, the majority in all the countries answered "Individual households, for ignoring the safety of their own houses", except Turkey, where the majority answered "Government officers (national and local)", as shown in Figure 2.3.11. The results are quite different from the results of the residents and the house builders / masons who answered the same question. The results of the second question indicated different stakeholders in different countries, as shown in Figure 2.3.12.

Figure. 2.3.11. Perception of who would be considered most responsible for damage to buildings and loss of lives due to earthquakes?

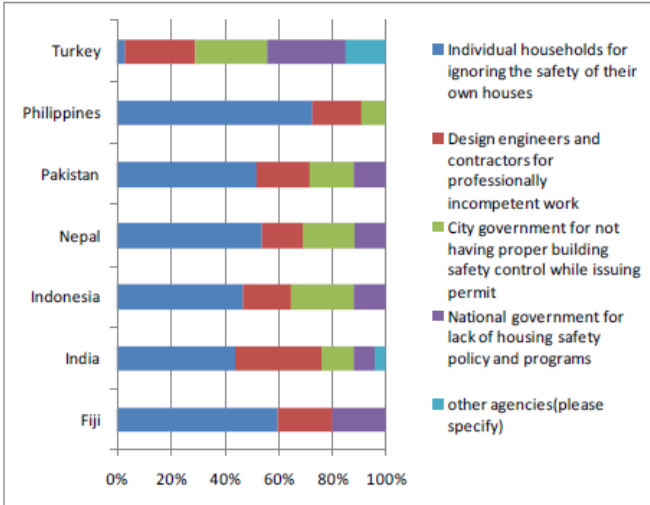
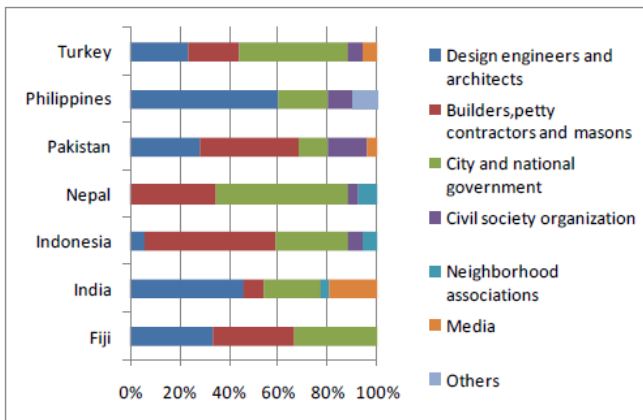

Figure. 2.3.12. Perception of potential largest contributor to the improvement of building safety in own cities



### Survey Results Analysis and Suggestions

This study has revealed possible entry points per stakeholder group to reduce disaster risks for non-engineered housing. It is essential for policy makers and government decision-makers to strategize policy intervention and investments based on actual facts and people’s risk perception.

For instance, policy implementation and capacity building that targets engineers would be effective where the results show that the majority identified engineers as playing the key role for housing safety, such as in Indonesia, Nepal, Japan and Turkey. However, the fact needs to be revealed as to what actually makes housing quality different. In countries where people showed less tendency

to rely on the government for housing quality, such as Indonesia and Nepal, the government could consider an alternative approach to utilize grassroots organizations or existing mechanisms in communities.

Survey results for builders and masons showed that they are confident about the safety of the houses that they build, although many of them do not know the building codes well. In such cases, builders and masons need to be aware of the gap between required skill and their current level, thus a technical training- and education mechanism would be effective to fill those gaps.

For many government officers, disaster-risk reduction would not be the highest priority, compared with the development of essential infrastructure or environmental issues, given the limited resources of many countries. Or government officers might think that individual houses are not under the responsibility of the national building-regulation framework. In such cases, policy makers need to take into consideration the stakeholders who can

contribute the most to improve building safety in given local-contexts.

## REFERENCES

1. Korel Eraybar, Alper Ilki, Kenji Okazaki, "Seismic Risk Perception in Avcilar", Proceedings of Turkish Sixth National Conference on Earthquake Engineering, October 2007, Istanbul, Turkey, Vol. 2, p. 41 – p. 51
2. Kenji Okazaki "Incentives to Encourage Investment in Earthquake Safer Housing", Proceedings of International Conference on Earthquake Engineering and Disaster Mitigation (ICEEDM08) April 2008, Jakarta, Indonesia, p.47-57
3. Kenji Okazaki et al, "Seismic Risk Perception of People for Safer Housing" 14th World Conference on Earthquake Engineering, October 12-17, 2008, Beijing
4. Korel Eraybar, Kenji Okazaki, Alper Ilki "An exploratory study on perceptions of seismic risk and mitigation in two districts of Istanbul" (p 71-92) "Disasters" Volume 34 Issue 1, January 2010

# CHAPTER 3

---

## CHARACTERISTICS OF NON-ENGINEERED CONSTRUCTION

---

### 3.0 Contents and Outline of Chapter 3

This chapter will first introduce typical damages of non-engineered constructions in the regions affected by major disasters (Section 3.1). Whereas the introduced non-engineered constructions and damages thereof are limited to the ones affected by Gorkha earthquake in Nepal (2015), Chile earthquake (2010), Sichuan earthquake in China (2008) and Kashmir earthquake in Pakistan (2005), many of the remarks and conclusions serve as lessons for the improvement of non-engineered constructions worldwide.

Section 3.2 introduces practices in non-engineered constructions in developing countries, such as planning, design and construction as well as compliance to local building code. The surveys shown in Section 3.2 show that each country has its own challenges; however, it also reveals that there exist similar technical and non-technical issues. Therefore, it is anticipated that the findings introduced in this section will lead to general recommendations to enhance safer non-engineered constructions.

### 3.1 Reports on damages to non-engineered constructions

#### 3.1.1 Seismic Impact on Non-Engineered Constructions

Many of damages due to earthquakes around the world do occur to non-engineered constructions. Damages to non-engineered construction usually lead

to much more number of fatalities – in comparison to damages to engineered construction. The main cause of this is the structural vulnerability; especially, masonry structure, which is one of the major non-engineered building typologies,

is composed of heavy and smaller pieces of construction materials and this fails to keep spaces for occupants to survive in the event of structural collapse, see Figure 3.1.1.

**Figure 3.1.1. Completed destroyed structure (Gorkha earthquake in 2015)**



Needs for actions have been called for by a number of entities (e.g. REF0). Whereas it is fair to say that concepts and approaches for natural hazard risk management in general have been understood and available for practice, these have been rarely applied for non-engineered constructions due to insufficient technical knowledge specific to non-engineered – in contrast to engineered constructions and critical engineered infrastructure such as highways, dams or nuclear power plants. Especially, the necessity of damage survey should be more emphasized from structural engineering viewpoint. By investigating damaged buildings, vulnerable elements of structures and failure modes are identified, and on this basis risk reduction measures can be examined. It is also mentioned that whereas in earthquake events which occurred at rural areas damages to non-engineered constructions

are focused and broadcasted by media (e.g. Gorkha earthquake in Nepal (2015) and Yogyakarta earthquake (2006)), in earthquake events where buildings in urban areas are damaged damages to non-engineered construction in rural areas are disproportionately less focused and broadcasted than engineered construction (e.g. Maule earthquake in Chile (2010) and Sichuan earthquake in China (2008)).

This chapter and the following chapter shed the light on the necessity of adopting the formal approach for natural hazard risk management for disaster risk reduction related to non-engineered constructions. This chapter specifically addresses the importance to learn and understand the physical mechanisms of the failures of non-engineered construction as the first step to develop measures for the improvement of their structural performances. For this purpose, findings are briefly introduced from the damage surveys after Gorkha earthquake in Nepal (2015), Chile earthquake (2010), Sichuan earthquake in China (2008) and Kashmir earthquake in Pakistan (2005).

### 3.1.2 Gorkha Earthquake in 2015

#### General information

On Saturday, April 25, 2015, a 7.6-magnitude earthquake (recorded by Nepal's National Seismological Centre (NSC), and 7.8 according to USGS) occurred at Barpak in the historic district of Gorkha, about 76 km northwest of Kathmandu (Figure 3.1.2). More than 300 aftershocks were observed. Four of these aftershocks were greater than magnitude 6.0, including

a 6.8-magnitude aftershock on May 12. The government of Nepal announces that the numbers of casualties and injuries exceeds 8,790 and 22,300 respectively. It is estimated that 8 million people, which amounts to approximately one-third of the population in Nepal have been impacted by the earthquakes and the aftershocks (REF1). Majority of damages occurred at non-engineered constructions, see Figure 3.1.3.

**Figure 3.1.2. Location of epicenter**

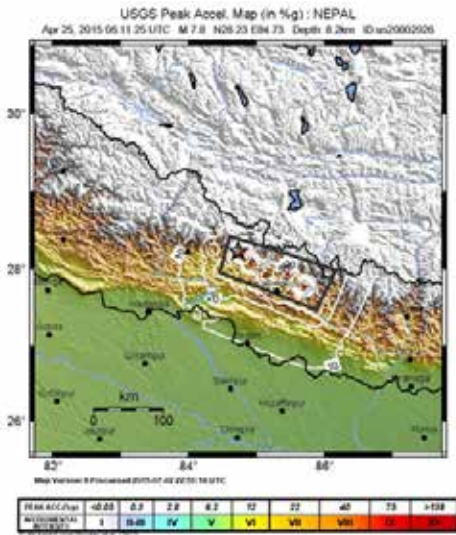

**Figure 3.1.3. Damages of houses (Sindhupalchowk Districts)**



**Non-engineered constructions and their damages**

In the urban area, newer buildings are framed by reinforced concrete with brick-infill wall (Figure 3.1.4). In older times people have not built their houses taller than temples; in present days, almost all the houses are taller than temples. Traditionally, properties have been inherited to sons where a multi-story family house was divided VERTICALLY and a portion was allocated to each son. Structural elements of these divisions often have been extended and modified; however, these extensions and modifications have been made without reference to sound engineering knowledge (REF2). As a consequence, majority of buildings cannot be considered structurally sound. Although many of these buildings did not collapse in the event of the earthquake, these are considered to be in danger of collapse in future earthquakes.

In the rural area, most buildings are single- or two-story masonry houses. These are typically non-engineered constructions, the construction materials of which are: brick, adobe, rubble stone, and dressed stone for masonry walls; mud, lime and cement for joint mortar. Especially, buildings built with mud mortar have been damaged or collapsed by the earthquake. The mud mortar generally carries little resistance and its resistance characteristics of the mud mortar in any given building is not clear, because it varies depending on the site. It is recognized by local people that the cement is a better material for joint. However, it is difficult for people in some villages to use it, since the material is relatively expensive and transportation infrastructure (roads and vehicles) is not well developed. Those people have used



mad mortar and built houses based on their own experiences. As a result, various kinds of failure modes such as collapses, out-of-plane failure, in-plane failure and delamination have occurred in the event

of the earthquake (Figure 3.1.5 to Figure 3.1.7). Figure 3.1.8 shows an example of damage of a building which applies industrial materials of cement and steel bar with little intervention of engineers.

**Figure 3.1.4. RC frame with masonry infill walls in urban area**



**Figure 3.1.5. Out-of-plane failure in masonry walls**



**Figure 3.1.6. Separation of joints of walls (sides) and in-plane shear cracks (middle) in masonry walls**



**Figure 3.1.7. Delamination of masonry walls**



**Figure 3.1.8. Damages to RC-framed brick building (Sindhupalchowk District)**



### 3.1.3 Chile Earthquake in 2010

#### General information

At 3:34 AM in local time on February 27, 2010, an 8.8-magnitude earthquake according to USGS occurred at the coastline of Chile. This earthquake and the following tsunami caused 486 fatalities and 79 missing persons. More than two million people were affected, 1.5 million buildings were damaged, and the economic loss amounted to 30 billion US dollar (REF3). Whereas damages to high-rise buildings in urban areas attracted international attentions, there were enormous amount of damages to historical buildings in urban areas as well as damages to non-engineered constructions in villages in rural and mountain areas.

#### Adobe constructions and their damages

Among the constructions damaged by the earthquake, damages to adobe constructions were significant. According to the Ministry of Housing and Urbanism, variety types of new construction materials became available due to the rise of construction material industries during 1940-1960. As a consequence, the ratio of adobe construction to the total building construction has been declined. At present, new adobe constructions are rarely built. On the other hand, however, since adobe constructions are durable, substantial amount of adobe constructions are remained in use in rural villages. Note also that many of church buildings and other historical buildings are adobe constructions. It is those adobe constructions that were damaged more heavily by the earthquake.

In urban areas, it is not easy to realize that buildings are indeed adobe constructions until it get damaged, as it cannot be told by the appearances of the buildings (Figure 3.1.9). Adobe constructions and high-rise buildings are often located next to each other. This fact is rarely recognized in usual occasion but the earthquake made contrast in damages, see Figure 3.1.10.

In remote areas, newly constructed houses including social housing for low-income people are constructed elsewhere separated from historical districts of old villages. As a consequence, building stocks in historical districts remain to be adobe constructions, which were typically built long time ago, one of which was estimated to be built in 1826 –200 years ago – from the plate attached to the house. Figure 3.1.11 shows an example of totally damaged adobe construction. Poor conditions on roofing and walls indicated that the earthquake-resistant performances of these constructions decreased due to the lack of appropriate maintenance work, see Figure 3.1.12.

**Figure 3.1.9. Damaged adobe construction in Santiago**



**Figure 3.1.10. Damaged adobe construction located next to undamaged high-rise building in Talca**



**Figure 3.1.11. Damaged adobe construction in Nirihiulo in Maule Region**



**Figure 3.1.12. Adobe construction without appropriate maintenance work in Huerta del Maule in Maule Region**



### **Social and economic situation regarding adobe construction**

In contrast to many low-income regions of the world, Chile enjoys economic development to some extent. Thus, modern houses utilizing industrial materials became popular, while adobe constructions have become less popular as common means for house construction. In parallel, the society finds cultural values in traditional adobe constructions. Some of those traditional adobe constructions are rehabilitated and converted into modern houses

or hotels. There also are commercial buildings of adobe construction. The Chile Earthquake reveals that countries which have achieved economic development to a certain level, have social and economic situation different from less developed countries such as considerable amount of stock of the old buildings (very small number of new construction) and the cultural value for the people and society. These situations should be taken into account in developing and implementing risk reduction measures. The approach for risk reduction should be different

from that of less developed countries, where safer construction technology for new buildings is one of the critical issues mainly from view point of feasibility for workers and affordability for owners.

### 3.1.4 Sichuan Earthquake in 2008

#### General information

At 2:28 PM in local time on May 12, 2008,

an 7.9-magnitude earthquake at the depth of 19 km (according to USGS, 8.0 magnitude and 14 km in depth according to CEA) occurred in Sichuan area (Figure 3.1.13) This earthquake caused 69,227 fatalities, 373,643 injuries and 17,923 missing people (REF4).

This earthquake attracted damages to RC school buildings, middle/high-rise buildings and shopping centers in urban areas; however, many individual houses were also damaged.

Figure 3.1.13. Seismic intensity distribution (China Earthquake Administration)

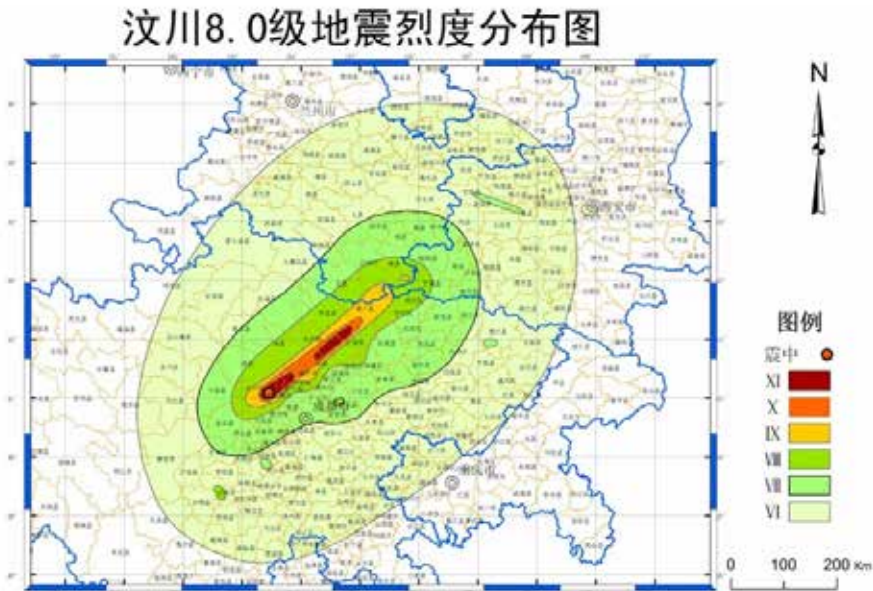

#### Local houses and their damages

The damage survey (REF5) in a selected village revealed that variety of construction types and materials were employed and used ranging from timber frame, brick masonry, concrete block to precast concrete panels . 10 houses in the village were investigated and all were damaged. The investigated damaged houses included five brick masonry

houses, two timber houses and one concrete block house. (Two were unable to identified from appearance) Among the five brick masonry houses, two of them were stretcher bond and one of them was header bond. The two timber houses seemed to be built since long. It was estimated that timber houses were traditional construction in this area. A house was built with hollow core slabs

PCa (precast concrete panels) for slab at the second floor (Figure 3.1.14 and Figure 3.1.15).

The village was located in the vicinity of active faults and most of the buildings were severely damaged. It is remarkable that two timber houses, one of which were in fact in use after the earthquake, were damaged only to minor degrees. These houses were built with traditional constructions with columns, beams and penetrating tie beams and not using bracing nor bearing walls (Figure 3.1.16).

On the other hand, houses built with modern industrial materials such as concrete block (Figure 3.1.17) or hollow core slabs PCa were total collapsed. This tells the importance of sound skills to command industrial materials for expected performance. Damages to brick masonry buildings were found (Figure 3.1.18), which had been repeatedly reported in previous damage surveys. Roof structure collapses were found, which was due to the failure of gable walls (Figure 3.1.19). Wall failures due to share forces were commonly found.

**Figure 3.1.14. Damaged house with hollow core slabs PCa**



**Figure 3.1.15. The same building as in Figure 3.1.14. (Hollow core slabs were observed)**



**Figure 3.1.16. Timber house that did not collapse**



**Figure 3.1.17. Damaged concrete block house**



**Figure 3.1.18.**  
Damaged brick house



**Figure 3.1.19.** Collapsed building due to failure of gable wall



### 3.1.5 Kashmir Earthquake in 2005

#### General information

On October 8, 2005 a large scale earthquake (M7.5) struck northern part of Pakistan. The epicenter of the earthquake located in Kashmir district governed by Pakistan (Figure 3.1.20). It caused damages in Pakistan, India and Afghanistan and most seriously in Jammu and Kashmir district and North West Frontier Province in Pakistan. The number of casualties and damages to houses are shown in Table 3.1.1 and Table 3.1.2.

**Figure 3.1.20.** Location of the epicenter



**Table 3.1.1.** Number of casualties

Country	Pakistan	India
Dead	73,338	1,309
Seriously injured	69,412	-
Injured	58,897	6,622
Homeless	About 2,800thousand	About 150 thousand

Source: Government of Pakistan, Government of India, International Organization for Migration (IOM), USAID.

Table 3.1.2. Destroyed and Damaged Housing Units in Pakistan

Area	Destroyed	Damaged	Total
Azad Jammu Kashmir(AJK)	116,572	88,368	204,940
North West Frontier Province (NWFP)	87,007	108,205	195,212
Total (AJK+NWFP)	203,579	196,573*	400,152*

Source: Pakistan 2005 Earthquake Preliminary Damage and Needs Assessment, Islamabad, Pakistan, November 12, 2005, by Asian Development Bank and World Bank

\*The total number is recalculated with the original data of each area.

### Non-engineered constructions and their damages

#### Confined masonry structures

RC frames are common in many parts of Pakistan. This type of structure can be seen not only in big cities but also in smaller cities or towns, especially for non-residential use with two or more stories. This type of structure commonly observed is so called confined masonry with RC frames. The confined masonry structure is constructed in a few steps: 1) set up brick or block wall, 2) install reinforcement steel bars for columns and beams, and 3) finally place concrete. The section of RC members, such as column and beams, is rather small (15-20cm in each direction) compared with that found in developed countries. It is commonly assumed masonry walls and confining RC members work together against earthquakes. (RC frame with masonry wall is similar to confined masonry but different in structural system (RC frames are the structural members and usually have larger dimension) and in construction procedures (Infill walls are constructed later than the frames).

Majority of the failure modes are identified in connections between columns and beams, sill beams or other members, see Figure 3.1.21. On the other hand, failures of steel bars (broke in yielded condition which occur when a structure performs ductile

behavior) were not found. Possible causes of the failures in connections are due to 1) too small design lateral force; otherwise not considered, 2) improper connection of reinforcement bars, and 3) inappropriate location of joints of concrete placement in connections of columns and beams.

Figure 3.1.21. Connection failure



The quality of materials and labor work were often found poor. Also it was often found that concrete with honeycomb and steel bars had been deeply eaten up with rust.

#### Masonry structures

Various kinds of construction materials, including industrial materials, were used even within a village. These included mud, natural stones, cut stones, adobes, bricks, concrete blocks and cement. It was also common that several kinds of materials were used in a single house.

Typical failure modes of masonry such as out-of plane failure, in-plane failure, separation of walls at corners and delamination of walls were observed. The extent of damage differed significantly from building to building, ranging from no cracks to collapse. Several factors for this large variability were considered: 1) different inputs of lateral forces due to different ground conditions or others, 2) different designs such as plan (simple or complex), size and location of openings,

weight of roofs, etc. 3) effective structural members resistant to lateral forces such as tie bands, tie beams, etc., 4) quality of materials and 5) quality of construction work.

It should be also noted that modern construction materials and technologies had been introduced, which however were not always effectively employed. For example, a new house constructed with solid concrete foundation received critical damages (Figure 3.1.24).

**Figure 3.1.22. A house made of various materials of natural stone (lower left), dressed stone (upper left) and bricks (right)**



**Figure 3.1.23. A house made of solid concrete blocks**



**Figure 3.1.24. Adobe house damaged by the earthquake**



**Figure 3.1.25. A house made of natural stone with mud mortar**





**Figure 3.1.26. A school building made of dressed stone**



### Reference

1. REF0: Living with Risk- A Global Review of Disaster Reduction Initiatives 2004 version, Inter-Agency Secretariat of the International Strategy for Disaster Reduction (ISDR)
2. REF1: "Nepal Earthquake 2015 Post Disaster Needs Assessment", Government of Nepal National Planning Commission.
3. REF2: "Heritage Homeowner's Preservation Manual", Dr. Rohit K. Ranjitkar, UNESCO Bangkok.
4. REF3: UNOCHA, Weekly Note on Emergency on April 12, 2010 and Chile Earthquake Situation Report #3 on March 3, 2010
5. REF4: China Earthquake Administration, Report on Damage by the Earthquake 2008 REF5: "Record of the Activities on the Investigation of the Building Damage and Restoration by the 2008 Sichuan Earthquake" Building Research Data No,118, May 2009, Building Research Institute (BRI)

## 3.2 Construction practice of non-engineered constructions

### 3.2.1 Overview

Non-engineered construction is defined in Chapter 1 as "buildings which are spontaneously and informally constructed in the traditional manner without intervention by qualified architects and engineers in their design" and has the large variety in each of areas regarding materials, construction methods, skill and knowledge of workers, available tools and facilities on site and so on. As most of them do not follow official procedures such as building permits, statistic data on it is almost none. Under this situation a report by UNESCO/IPRED study group (refer to ANNEX 3.1) provides very precious information on overview of current practice of non-engineered construction.

The survey was organized by Institute

of Technology Bandung, Indonesia and National Graduate Institute for Policy Studies (GRIPS), Japan and conducted by research institutes in seven selected countries namely Egypt, India, Indonesia, Nepal, Pakistan, Peru and Turkey. Each research institute selected several sites in urban areas where typical and common type of non-engineered buildings were being constructed and surveys were conducted covering delivery system (owner, contract type, intervention of engineers, and so on), outline of design (usage, floor area, number of stories, and so on) and construction works on site (materials, detail on major structural and non-structural members, number of workers and their skills, and so on). Even though it has limitation of samples (limited number of samples in selected districts in urban area) and the survey

method (some of the sample buildings were not being constructed at the time of the survey and some data was based on not field survey but others like interviews), it provide significant overview of non-engineered construction. It tells that non-engineered construction is much different from engineered construction. It also shows that those in each country are different from each other. Key information of the report could be summarized as follows.

- Most of non-engineered construction are masonry and unconfined

type (masonry walls are not confined(supported) by reinforced concrete members such as columns and beams) is prevalent among them

- All of the countries use ordinary Portland cement as the construction materials
- The quality of materials such as compressive strength of brick and concrete has huge difference
- Mixture ration of concrete is different among the counties and several construction sites were found where measurement in mixing was not applied

Figure 3.2.1. Ratio of construction types (unconfined masonry (left), confined masonry (right))

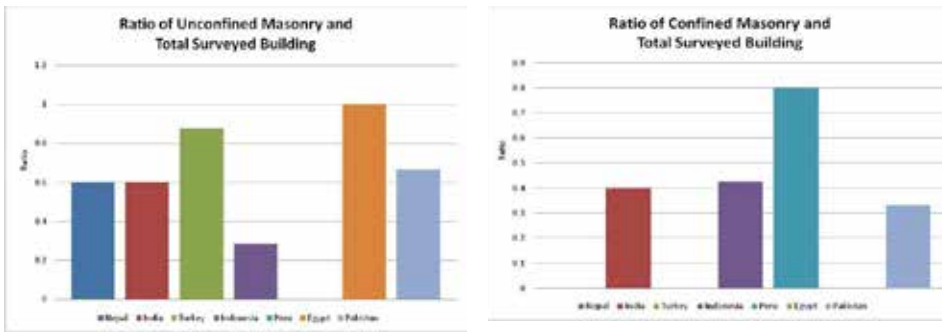
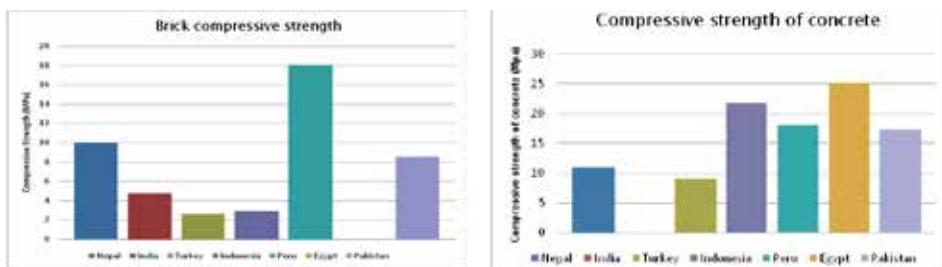

Figure 3.2.2. Comparison of compression strength (brick (left), concrete (right))



Reference

1. K. S. Pribadi , K. Okazaki, D. Kusumastuti, T. Saito, E. Lim, A. Utami, research findings of the survey on non-engineered houses in developing

countries, surveys and activities on post-earthquake disaster (Proceedings of UNESCO-IPRED-RIHS International Workshop Padang, Indonesia, 6 - 8 July 2010) pp 133-151, UNESCO July 2011

## 3.2.2 Significance of Field Survey on Construction Practice

### Huge gap between design and construction practice

Reinforced concrete structures in developing countries often got heavy damage. Most of them got broken at connection of structural members and often became flattened or heavily tilted as seen in Figure 3.2.3 and Figure 3.2.4. In most of the cases, the reinforcing steel bars were not broken, but seemed to come off judging from the fact that all the ends of rebar did not have signs of yielding. Local engineers usually explain the cause of this type of failure is that construction workers are non-skilled and do not have engineering knowledge or are negligent and not follow the correct way. A survey on construction site in Aceh in Indonesia revealed it is not true. Figure 3.2.5 is a drawing of bending works of rebar prepared by consultants for reconstruction project in Aceh from disaster caused by the Indian Ocean Earthquake and Tsunami. The drawing requires overlapped splices to prevent coming off of rebar. Whereas the construction practice on sites are shown in Figure 3.2.6. It shows rebar were assembled on the ground (Figure 3.2.7) and the assembled rebar was just placed in the way shown in Figure 3.2.8. Tools for bending work are usually timber bending bed with nails and steel bar with hook for manual work. Under this situation of tools and construction procedures, it is impossible to implement bending works required by

the drawing. Comments by engineers who designed the houses were that they draw the bending drawings according to the guidelines/recommendations they learned at schools, training programs or others, most of which are direct quotation from those of developed countries. Regarding construction practice on site, some of the engineers actually do not know the situation because they have completely no interest in them. And some believe their job is limited to design and drawings, not consideration on construction works. Even though they know it is impossible for workers to follow the drawings, they claim that it is responsibility of workers to follow as the engineers should not be blamed because they exactly follow the way they learned.

This experience shows there is a huge gap between engineering/design and construction practices on site. The engineers follow what they learned in their professional education/training. Most of them are direct import from developed countries and do not reflect conditions of construction site of developing countries. The workers conduct construction works as they learn from their experience of construction work on site or technique and advice from master builders or senior colleagues, who have little opportunity to learn engineering. Furthermore there is usually no dialogue/discussion between engineers and workers. The example mentioned above is only a single issue but a proof evident enough to show that there exists a huge gap between engineering and construction practices.

Figure 3.2.3. Collapsed buildings by the Northern Pakistan



Figure 3.2.4. Failures often occurred in Earthquake 2005 in Balakot connections of structural members



Figure 3.2.5. Drawings of bending works for reconstruction houses in Banda Aceh, Indonesia

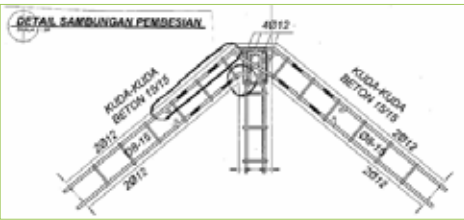

Figure 3.2.6. Construction practice on site Insufficient connection of longitudinal rebar



Figure 3.2.7 Bending works on site with simple tools  
Assembling of rebar is also conducted on ground



Figure 3.2.8. Placing the assembled rebar of a roof beam fabricated on ground



### Significance of field survey on construction practice

There is a big difference between engineered and non-engineered in every aspects and non-engineered has little/ no technical intervention in construction work. Furthermore there is not enough information on non-engineered construction because most of engineers and researchers are not interested. These facts lead to recognize that basic studies on construction practice and actual situation on sites, workers and construction procedures is essential as a basis of study for mitigation of earthquake disasters. They will reveal causes and procedures how and why vulnerable structures are created, and provide practical information what kind of improvement of the design will be feasible on site.

### 3.2.3 Monitoring Surveys of Construction Procedures on Sites

#### Outline of Monitoring Activities

Monitoring surveys on confined brick masonry structure was conducted in Peru and Indonesia by Building Research Institute on Japan (BRI) in 2007. Confined brick masonry structure has brick walls confined by small section of RC members in both sides and upper end such as beams and columns. (This type is usually differentiated from RC frame with masonry infill) Similar types of buildings/houses are found in almost everywhere in the world and often suffered heavy damage from earthquakes. Construction sites for monitoring survey are typical and average ones commonly found in each country.

#### a) Monitoring activities in Peru

- **period:** October to November, 2007
- **area:**

Caral, Distrital de Supe, Provincia de Barranca, Departamento de Lima, Peru  
Distrital de Villa Salvador, Provincia de Lima, Peru

#### b) Monitoring activities in Indonesia

- **period:** October to December 12, 2007, January to March 1, 2008
- **area:**  
Desa Sidomulyo, Kecamatan Bambang Lipro, Kabupaten Bantul, Propinsi Daerah Istimewa Yogyakarta  
Kr. Takun Imogiri, Kecamatan Imogiri, Kabupaten Bantul, Propinsi Daerah Istimewa Yogyakarta  
Desa Wonokromo, Kecamatan Prelet, Kabupaten Bantul, Propinsi Daerah Istimewa Yogyakarta

### Overview of Construction Practice in Lima, Peru

- Concrete mixing: Cement, sand and aggregate are mixed directly on ground (Figure 3.2.9). Those are batched by volume with barrow.
- Excavating and foundation: Excavating depth is around 50cm. Foundation is about 40cm in width and about 40cm high above ground level. (Figure 3.2.10)
- Brick laying: Brick laying is conducted neatly and accurately with taut line and plumb bob (Figure 3.2.11).
- Bending work of rebar: Length of overlapped splices was not sufficient as rebar is fabricated with hoops on ground, placed and no bending works on the spot (Figure 3.2.12).
- Forms for concrete placing: Forms are made of timber. Packing of small piece of cement bags to fill crevices is often found (Figure 3.2.13).
- Concrete placing: Compaction is not enough. Honey comb and exposure of rebar is often found (Figure 3.2.14).

Figure 3.2.9. Concrete mixing on ground on site Mixing is carried out without sheets or others tools



Figure 3.2.10. Excavation works for foundation



Figure 3.2.11. Laying work of bricks with plumb bob Taut line is usually used



Figure 3.2.12. Corner of beams and column Length of lapped splices is limited to the dimension of RC members' section size because of fabrication method



Figure 3.2.13. Form works Packing of small piece of cement bags is usually



Figure 3.2.14. Honey comb in beam Some of rebar is exposed to air observed



### Overview of Construction Practice in Central Java, Indonesia

The monitored houses are those constructed for reconstruction from the Central Java Earthquake 2006 with financial and technical support of JRF (Java Reconstruction Fund: Multi donor fund by European Commission, European countries and others). JRF provided technical support by printed guidelines and periodical supervision by technical staff.

- Concrete mixing: Cement, sand and aggregate are mixed directly on ground (Figure 3.2.15). Those are batched by volume with barrow just same as in Peru.
- Excavating and foundation: Excavating depth is around 80 cm. Foundation is about 40 cm in width and about 15 cm high above ground level. (Figure 3.2.16)
- Brick laying: Brick laying is conducted neatly and accurately with taut line

**Figure 3.2.15. Concrete mixing on ground on site Mixing is carried out without sheets or other tools**



(Figure 3.2.20) and plumb bob.

- Bending work of rebar: Rebar is fabricated with hoops on ground with simple tools such as steel bars with hook (Figure 3.2.17). Improvement on several aspects recommended by JRF was found such as continuous rebar in beams at corners (Figure 3.2.18) and anchorage between walls and columns (Figure 3.2.19). Each of them seems effective to improve seismic performance but needs further improvement from view point of efficiency of construction works because they required complicated and time consuming works.
- Forms for concrete placing: Forms are made of timber. Packing of small piece of cement bags to fill crevices is usually found.
- Concrete placing: Compaction is not enough. Honey comb and exposure of rebar is often found.

**Figure 3.2.16. Excavation works for foundation**



Figure 3.2.17. Bending works of rebar on ground with simple tools without machines



Figure 3.2.18. Connection of RC members Horizontal rebar for beams is not connected at the corner



Figure 3.2.19. Anchorage of walls to column



Figure 3.2.20. Laying work of bricks with taut line





# CHAPTER 4

---

## TECHNICAL APPROACHES FOR STRUCTURAL IMPROVEMENT OF NON-ENGINEERED CONSTRUCTION

---

### 4.0 Contents and Outline of Chapter 4

Structural behavior of non-engineered construction is only poorly known in general. Especially, evidences supported by experiments are missing. The development of such evidence and accumulated engineering knowledge on non-engineered construction is the first step toward the development of measure for structural improvement of non-engineered construction.

This chapter will outline the technical approaches by which the structural behavior, hence, performance of non-engineered construction is assessed on the basis of experiments and analysis. In the subsequent section, several possible structural improvement measures are introduced focusing on retrofit of existing buildings. Several examples of experimental study on innovative and unique measures are shown in Box Stories as well.

Large number of non-engineered constructions in developing countries have been repeatedly damages by earthquakes. These constructions are built with little intervention from engineers, utilizing local construction materials such as adobe, stone and brick. This contrasts to engineered constructions, which are designed and constructed by engineer experts utilizing industrial materials whose quality is well controlled. Whereas the structural behaviour and performance of engineered construction are generally well understood, those of non-engineered construction are only poorly understood. For the purpose to facilitate the development of structural performance of non-engineered construction, their structural behaviour must be understood as is true to the engineered construction.

## 4.1 Understanding Structural Behavior of Non-Engineered Construction

### 4.1.1 Necessity of Conducting Experiments and Analyses

As seen in Chapter 3, field surveys on damaged constructions due to earthquake are the very first step to understand the structural behaviour of the constructions. However, whereas the surveys provide useful information on typical failure modes thereby identifying the weak points of damaged constructions, it often involves guesses on how those constructions behaved subjected to ground motions and eventually resulted in the failures; it also cannot provide quantitative information on the structural performance. This is where experiments and analyses come in to the picture. The experiments and the analyses include but not limited to:

- Testing for construction materials and structural elements,
- Dynamic collapse experiments with scaled or full-scale models
- Numerical analysis.

These experiments and analyses are commonly and widely utilized for the understanding of the structural behaviour of engineered construction – i.e. the techniques and tools are well established and readily available.

In the subsequence subsection, two examples of studies are briefly introduced: one for dynamic collapse experiments and the other for numerical analysis, see for the detail [REF1]

### 4.1.2 Dynamic Collapse Test using Shaking Table

#### Objectives and outline

The objectives of this test are to reproduce collapse procedures and to record it in date of acceleration and displacement utilizing three-dimensional displacement measurement with LED, and to shoot video image of collapse procedures from 10 different positions. For the objectives, the specimen was fabricated following construction practice in the developing country (Pakistan in this test) such as bricks, mixture ratio of cement mortar, brick laying method, detailing of members and other practice. The data and video image were used for numerical analysis in the following subsection.

#### Model structure

As model structure, a simple brick masonry structure was here designed for the dynamic collapse test. The model structure had dimensions of approximately 3m x 3m x 3m and was constructed using solid bricks. In like manner to houses found in the mountainous area of Pakistan illustrated in Figure 4.1.1, a simple roof of folded steel sheets with wood beams was left unfixed and was placed on the walls with short wooden posts/stoppers to prevent it from shifting or falling down.

Figure 4.1.1. Small town in mountainous area (left), damaged light roof building (middle) and light roof brick masonry house (right)



Openings are located in the east, north and south walls, but not in the west wall. The bricks of walls were laid in English bond brickwork 230mm thick. Bricks with dimensions of 230 mm x 110 mm x 70 mm weighing 2.92 kg were imported from Pakistan. The bricks were soaked in water before laying. The mixture ratio

in terms of the weight of the mortar for brick laying is as follows: Portland early-strength cement : sand = 1:8; Portland early-strength cement : water = 1:1. The mortar joint thickness was approximately 15mm, and the brick wall had 32 layers. The shaking table used and the model structure are shown in Figure 4.1.2.

Figure 4.1.2. Shaking table and model structure

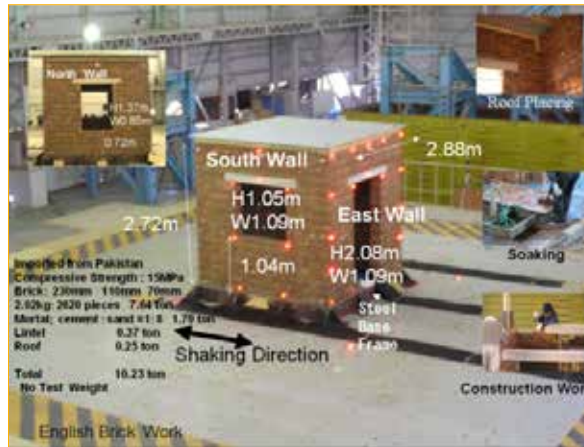

### Input waves

Sinusoidal waves, rectangular waves, and strong earthquake records were used as input signals for the shaking table. Two strong earthquake motions were selected from records of past earthquakes. One was an EW (East- West) component wave observed at the Bam Governor's Building in the Iran Earthquake on December 26,

2003; this wave is referred to as "Bam" hereinafter. The other was an NS (North-South) component wave, which was observed at JMA (Japan Meteorological Agency) Kobe Observatory in the Great Hanshin Earthquake of 1995; this wave is referred to as "JMA Kobe" hereinafter. In using these waves as the input to the shaking table, time-reduction was applied.

Figure 4.1.3. Time-reduced Bam L(EW) wave and JIMA Kobe NS wave (response wave)

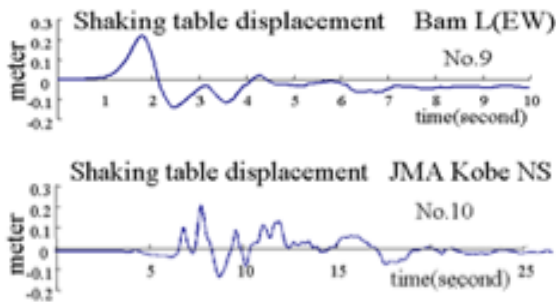

### Test results

Several different input waves were applied as shown in Table 4.1.6. As shown in the table (right most column), there haven't observed any damages up to the Excitation number 5. The model structure collapsed

by the input wave of the Excitation number 10, which is the amplified JMAKOBÉ NS. The intermediate damage state of the model structure is shown in Figure 4.1.4. The final state of the model structure is shown in Figure 4.1.5.

Figure 4.1.4. Process of specimen collapse in the shaking table test (Excitation number 10)



Figure 4.1.5. Model structure after shaking



Table 4.1.1. List of input waves and states of the model structure

Excitation Number	Type of Input Wave	Time scale	Amplitude		Results
			(Target)	(Observed)	
No. 1	2003 Iran Bam Eq. L (EW)	0.79	75cm/s	73cm/s	No Cracking
No. 2	2003 Iran Bam Eq. L (EW)	0.79	100cm/s	94cm/s	No Cracking
No. 3	1995 JMA KOBE NS	1	100cm/s	104cm/s	No Cracking
No. 4	Sin 15Hz duration 50 seconds	-	10.4cm/s	10.2cm/s	No Cracking
No. 5	Sin 1Hz duration 20 seconds	-	63cm/s	64cm/s	No Cracking
No. 6	Pulse Shock 1	-		40cm/s	Cracking
No. 7	Pulse Shock 2	-		-40cm/s	Cracks expanded
No. 8	Pulse Shock 3	-		30cm/s	Crack did not expand
No. 9	2003 Iran Bam Eq. L (EW)	0.79	100cm/s	94cm/s	Cracks expanded
No. 10	1995 JMA KOBE NS	1	100cm/s	104cm/s	Collapsed

### 4.1.3 Numerical Analysis

#### Objectives and outline

The objective of the analysis is to create a numerical model which reproduces behavior of masonry structures during shaking motion. Reliable models enable simulation of behaviours in various condition such as different shaking motion, different design of configuration, height of buildings and openings, different materials of bricks and mortar, and so on. Further they could be used for estimation of effectiveness of proposed reinforcing methods. In this analysis study Extended Distinct Element Method is used as it is one of most suitable one for masonry structures.

#### Extended Distinct Element Model

The Distinct Element Method (DEM) is a technique for numerical analysis and a method where material is considered to be an assembly of circular particles and there are no forces resisting traction. The DEM was extended to give the continuity, which is called "Modified DEM" or "Extended DEM". The model behaves as a continuous medium while the springs are intact; after some of the springs have broken, it is possible to trace the movement of the individual parts that were separated from each other and which caused the structure's unity to be destroyed. The Extended DEM has the mortar springs, although the particles are separated from each other, and the position of the mortar springs is defined at the initial state of the analytical model. Figure 4.1.6 illustrates the modeling of the DEM and the Extended DEM.

Figure 4.1.6. Illustration of DEM and Extended DEM

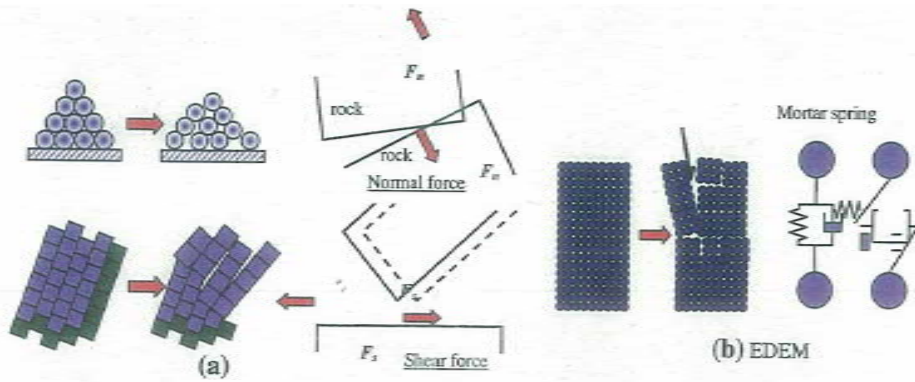

### Numerical model

The numerical models used in this analysis are depicted in Figure 4.1.7. The bricks were modeled as a rigid body (brick element). The configurations of the bricks elements were the same as in the test specimen (English bond brick

work). The total number of brick elements for the numerical models was 2,600. The number of degrees-of-freedom was 15,600. The mass of the analytical models was set to 10 tons. The mass of the roof plate is included in the total mass of the numerical model.

Figure 4.1.7. Illustration of the whole structure of analytical model (left) and element model of bricks and mortar (right)

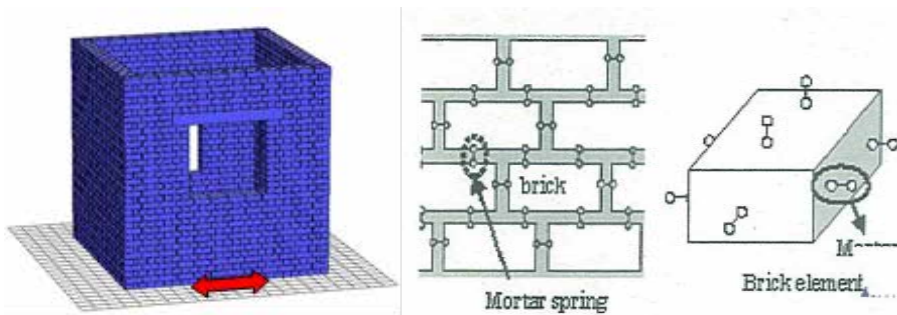

### Numerical simulation inputs

Numerical analyses were carried out using inputs listed in Table 4.1.1. These input waves correspond to the waves of the shaking table tests as shown in

Table 4.1.2. Input wave No. 9 and 10 were applied to the numerical model with the plastic behavior and the crack pattern in Excitation No. 8 retained. This differs from the shaking table test.

Table 4.1.2. List of input wave used in the numerical simulation

Number	Input wave	Damage of the numerical model
No. 2	2003 Iran Bam Eq. L (EW) TS=0.79 100cm/s	No Damage
No. 3	1995 JMA KOBE (NS) 100cm/s (110%)	No Damage
No. 6	Pulse Shock 1 40cm/s	Cracks occurred
No. 7	Pulse Shock 2 -40cm/s	Cracks expanded
No. 8	Pulse Shock 3 30cm/s	Cracks expanded
No. 9	2003 Iran Bam Eq. L (EW) TS=0.79 100cm/s	Collapsed

} Single String

### Simulation results

Figure 4.1.8 shows the result of the simulation of the second Iran Bam earthquake wave (No. 9). In the first

movement from left to right, the diagonal cracks expanded from the bottom-left to the top-right and part of the analytical model collapsed.

Figure 4.1.8. Simulated process of collapse by the Bam earthquake wave (No. 9)

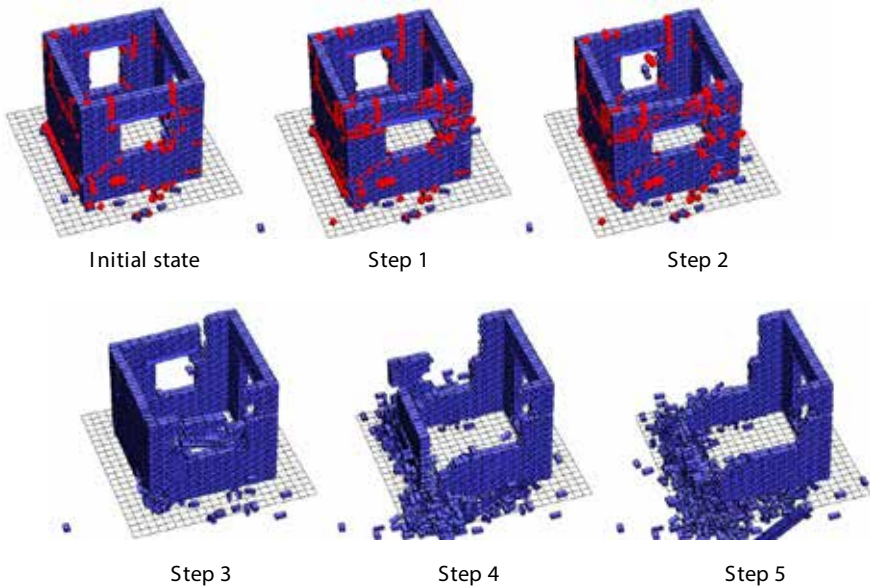

### References

- [REF1] Nakagawa, T., Narafu, T., Imai, H., Hanazato, T, Ali, Q. and Minowa, C., Collapse Behavior of a Brick Masonry House using a Shaking Table and Numerical Simulation based on the

Extended Distinct Element Method, Bulletin of Earthquake Engineering (BEE), Volume 10, February 2012, the European Association for Earthquake Engineering, pp.269-283

## 4.2 Possible Structural Improvement Measures

### 4.2.1 Introduction

Various structural improvement measures are proposed based on several backgrounds such as surveys on damaged buildings and the analysis of causes and vulnerability, structural experiments and numerical analysis. Structural improvement measures are anticipated to apply for both existing building stocks and newly constructed buildings. On the latter buildings, several measures are proposed for each of construction type in publication such as below.

In the following subsections, overview of structural improvement for existing buildings is explained on which reports and research papers are far less.

#### Examples of publications on Several Measures for Structural Improvement

- GUIDELINE FOR EARTHQUAKE RESISTANT NON-ENGINEERED CONSTRUCTION (refer to 5.2.2)
  - Masonry Buildings of Fired-Brick and other Materials
  - Stone Buildings
  - Wooden Buildings
  - Earthen Buildings
  - Non Engineered Reinforced Concrete Buildings
- TUTORIALS BY INITIATIVE OF THE WORLD HOUSING ENCYCLOPEDIA (refer to 5.2.3)
  - Adobe houses
  - Confined Masonry Structures
  - Reinforced Concrete Frame Buildings with Masonry Infill Walls
  - Stone Masonry Buildings

### 4.2.2 Structural improvement for existing buildings

In case of the structural improvement of existing buildings, it is called retrofit. In the next subsection, techniques for retrofitting are presented in case of unreinforced masonry constructions (URM), however, ideas or parts of them may be applicable for newly constructed buildings and/or other types of construction else than unreinforced masonry constructions.

From a general rehabilitation point of view, the concept of preservation of masonry buildings can be categorized as the following actions [REF4.1]:

- Stabilization
- Repair
- Strengthening
- Seismic retrofit

Stabilization is generally applied to historical monuments which are partially collapsed during the time and mainly deals with improvement in masonry materials subjected to gradual quality decay or failures caused by past earthquakes or human-made damages. In the other words, stabilizing saves the structural integrity of the existing buildings.

Repair deals with recovering of the initial mechanical or strength properties of the materials or structural components of URM structure. The purpose of repair is not to correct the deteriorations of structure and in this sense it is different from stabilization.



Since it is not clear if the initial structural performance of a URM structure meets the seismic requirements, there is a need to provide additional strength to building. Strengthening is aimed to respond to a more demanding level of structural safety.

Due to the earthquake-induced nature of the inertia lateral forces, sometimes strengthening is not the proper response and some other modifications in structural behavior are needed. In the other words, retrofit process may not necessarily contribute to the strengthening of URM structure. Even sometimes partial weakening (or adding ductility) of the structure may provide an adequate seismic performance. Therefore, retrofitting can be a better solution to respond the seismic demands of a URM building than only strengthening.

Also, the retrofit policies of URM structures may be categorized as partial and global retrofitting which includes the following features [REF4.2]:

- Improving structural connections
- Increasing the rigidity of floor slabs
- Increasing the strength/deformability of load bearing walls

As a global retrofit plan, all seismic acceptance criteria - including both partial and global behavior - should be fulfilled.

The most important factor that should be considered in the retrofit design of a URM structure, - whether a global or partial method - is the expected failure modes. Due to the complex seismic response of the components of a URM building and different study requirements, the failure causes of the structure should be prioritized. In-plane and out-of-plan failure mechanisms of the load bearing

walls play key role in the URM collapse. Therefore, retrofitting of URM walls is the most important part of a global retrofit plan.

The examples of the retrofit techniques of URM are listed as:

- Surface application
  - Jacketing (reinforcement and cementitious materials): such as shotcrete (Figure 4.2.2.1 (a)), reinforced concrete panel (Figure 4.2.2.6), ferrocement, steel wire mesh reinforcement, bamboo/cane reinforcement, old car tyre strips (Figure 4.2.2.2), textile reinforcement mortar, fiber-reinforced cement matrix (Figure 4.2.2.3), cement-based matrix-grid, polypropylene meshing (Box 4.2), engineered cementitious composite (Figure 4.2.2.5).
  - Jacketing (reinforcement and adhesives): such as cotton canvas sheet, fiber reinforced polymer (Figure 4.2.2.4), glass grid reinforced polymer.
  - Anchoring of reinforcement: steel strip (Figure 4.2.2.1 (b)), steel panel (Figure 4.2.2.7)
- Embedding reinforcements to walls
  - injection
  - re-pointing (Figure 4.2.2.1 (c))
  - twisted steel bars
- Coring and grouting
  - center core
- Post tensioning to wall
  - post tensioning (Figure 4.2.2.1 (d))
  - post tensioned cables
  - post tensioning using rubber tyres.
- Confinement
- Base isolation.

Several of these techniques are illustrated in Figure 4.2.1.

**Figure 4.2.1. Shotcrete, steel strip, re-pointing and post tensioning**

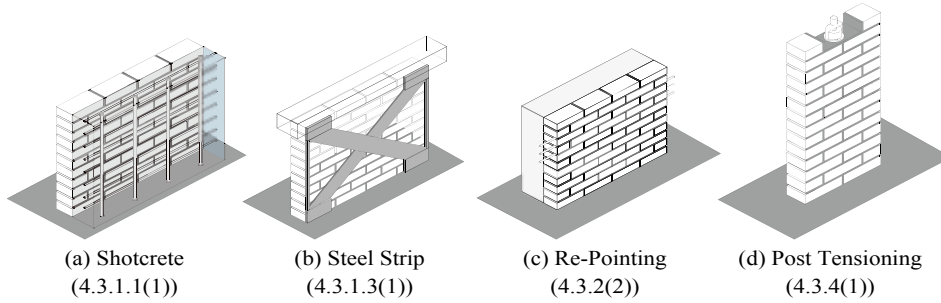

**Figure 4.2.2. Old car tyre strips [REF4.13]**

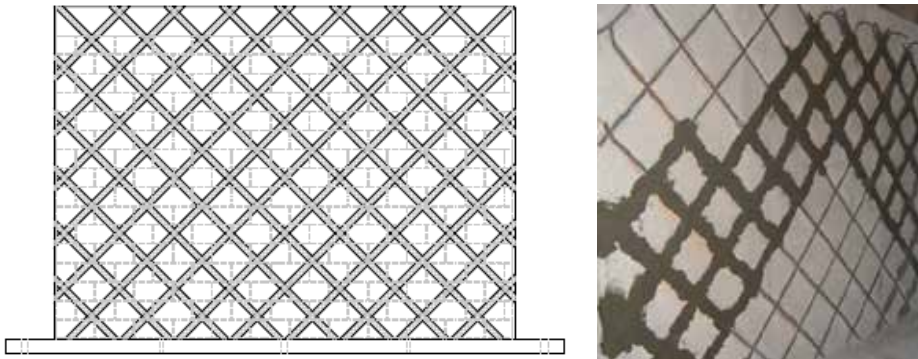

**Figure 4.2.3. Fiber-Reinforced Cement Matrix (FRCM) [4.16]**



Figure 4.2.4. Fiber Reinforced polymer  
(aromatic polyamide fiber)



Figure 4.2.6. Jacketing (reinforcement concrete panel)



Figure 4.2.5.  
Engineered Cementitious Composite



Figure 4.2.7. Anchoring of reinforcement (steel panel)



[4.1] EU-INDIA Economic Cross Cultural Programme (2006), Guidelines for the Conservation of Historical Masonry Structures in Seismic Areas.

[4.2] ASCE/SEI 41-06 Standard (2006), Seismic Rehabilitation of Existing Buildings, American Society of Civil Engineers.

[4.13] Kaplan, H., Yilmaz, S., Nohutcu, H., Cetinkaya, N., Binici, H. (2008),

experimental study on the use of old tyres for seismic strengthening of masonry structures, The 14th World Conference on Earthquake Engineering, Beijing, China.

[4.16] Faella C., Martinelli E., Nigro E., Paciello S. (2010), Shear capacity of masonry walls externally strengthened by a cement-based composite material: An experimental campaign, Construction and Building Materials, 24, 84-93.

### Box 4.1 Cane-reinforced adobe building

**Method:** Wall reinforcement

**Material:** Adobe with Cane

**Description:**

Based on some static trials, the most efficient reinforcement was achieved by placing the entire vertical rods inside the walls spaced 1.5 times the thickness of the walls, and tried to strips of crushed cane placed in mortar at every four rows (Figure 1, Diagram (right)).

The modules one was unreinforced and the other one reinforced (rod placed horizontally every 0.45 m and crushed cane in four courses and upper beam slab of wood) were tested using the vibrating table. Unreinforced building collapse after the separation of the walls at the corner (Figure 2. Left). Reinforced one maintains integrity even with repeated severe earthquakes (Figure 2. Right).

**Figure 1. Appearance of reinforcement (vertical rod of cane and horizontal crushed cane)**



**Figure 2. Breakdown pattern**

Unreinforced building

Reinforced building



**References**

1. Marcial Blondet, Julio Vargas, Nicola Tarque y José Velásquez : la tierra armada: 35 años de investigación en la PUCP
2. Scientific Sub-Committee on Seismic Performance of Masonry Constructions in Foreign Countries, Architectural Institute of Japan (AIJ), Technical Information for Disaster Mitigation of Masonry Structures, February, 2016

### Box 4.2 Masonry wallettes retrofitted by PP-band mesh

**Method:** Wall reinforcement

**Material:** Brick/adobe with PP-band

In this experiment, 1/4 scale model was used. Two experiments were conducted as 1) diagonal shear test, and 2) out-of-plane test. For each test, two kinds of specimens (unreinforced and reinforced by pp-band) were prepared. As the result of the diagonal test, compressive force increase two times in the case of brick with reinforcement of 40 mm pitch pp-band. As the results of the out-of-plane test, the followings were understood. The strength increased two times in the case of bricks and eight times in the case of adobe by the reinforcement. The deformation capacity improved about 60 times.

Figure 1. Diagonal shear test (brick@40mm) (unreinforced (left) and reinforced by pp-band (right))

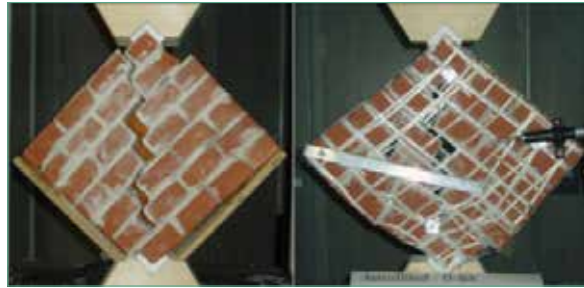

Figure 2. Stress-strain curve

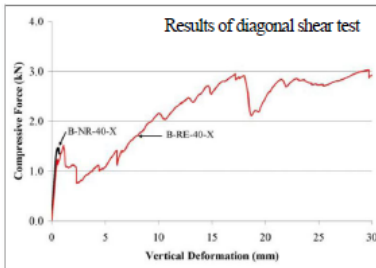

Figure 2. stress-strain curve (brick@40mm)

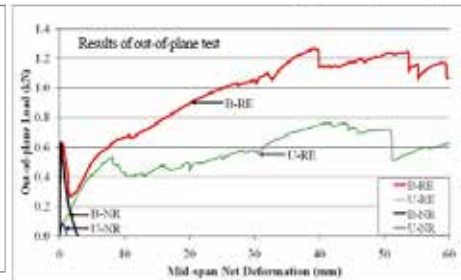

Figure 4. stress-strain curve (brick and adobe)

Figure 3. Out-of-plane test (brick) (unreinforced (left) and reinforced by pp-band (right))



#### References

1. N.Sathiparan, M.Paola and K.Meguro (2008): parametric study on diagonal shear and out of plane behavior of masonry wallettes retrofitted by pp-band mesh, The 14th World Conference on Earthquake Engineering October 12-17, 2008, Beijing, China
2. Scientific Sub-Committee on Seismic Performance of Masonry Constructions in Foreign Countries, Architectural Institute of Japan [AIJ], Technical Information for Disaster Mitigation of Masonry Structures, February, 2016

**Box. 4.3 Seismic retrofit of unreinforced clay brick masonry using polymer-cement mortar**

**Method:** Wall reinforcement

**Material:** Brick with polymer-cement mortar (PCM) and steel bar

**Description**

The study is to investigate the seismic performance of unreinforced masonry (URM) wall retrofitted with reinforced polymer-cement mortar (PCM). Four unreinforced clay brick masonry wall specimens with 100 mm in wall thickness were constructed first, then three of them were retrofitted with PCM applied on one of their surfaces forming a thickness of 40 mm, in which different vertical and horizontal steel bars had been arranged. The specimens were tested under cycle reversal loading method. Test results demonstrate that the application of reinforced PCM wall provides higher lateral load carrying capacity to URM wall, and also different failure modes were observed in three retrofit wall specimens.

**Figure 1. Construction of reinforced PCM wall**



Table 1 List of test specimens

Specimen	No.1	No.2	No.3	No.4
Wall thickness (mm)		40	40	40
Details of Reinforced PCM wall	/	3-411 (41)	3-411 (41)	1-D10 (41)
Vertical steel bars			D6 (47) @200 (Not anchored)	D6 (47) @200 (Anchored)
Horizontal steel bars			D6 (7) @200	D6 (7) @200
Elevation				

**Figure 2. Q-R envelop curves for all test specimens**

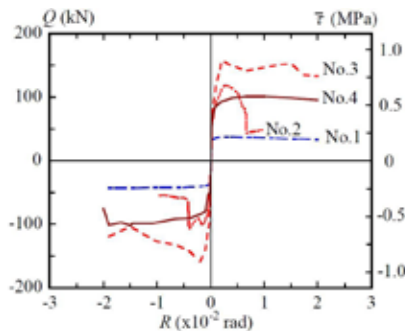

**References**

1. K. Kikuchi, M. Kuroki, M. Toyodome, C. Escobar, Y. Nakano : Seismic retrofit of unreinforced clay brick masonry wall using polymer-cement mortar
2. Scientific Sub-Committee on Seismic Performance of Masonry Constructions in Foreign Countries, Architectural Institute of Japan (AIJ), Technical Information for Disaster Mitigation of Masonry Structures, February, 2016

#### Box 4.4 Test for wind vulnerability assessment of non-engineered construction

Vulnerability against strong wind is another critical issue of non-engineered construction and needs to be investigated. Nishijima et al. [REF] investigates wind-resistant performance of a non-engineered construction located in the Leyte Island, the Philippines (see Figure 1), based on the field survey, wind tunnel experiment, material test. The outcomes of the experiment and test are then utilized for structural reliability analysis.

Figure 1. A non-engineered construction (left) and identified weak points by field survey (right).



The photos in Figure 2 shows material test set-up as well as typical failure modes of the connections.

Figure 2. Material test set-up and typical failure modes of the connections

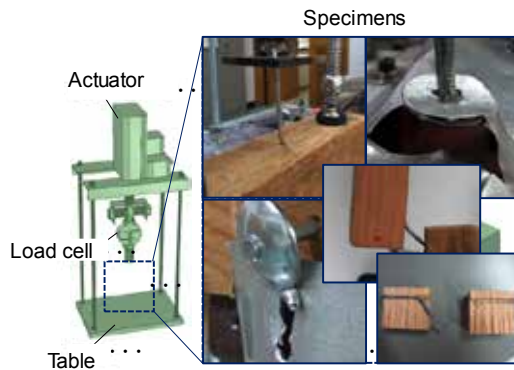

The result of the structural reliability analysis indicates that the probability of the collapse of the considered non-engineered construction is the order of  $10^{-1}$  per year, which means the mean recurrence period is about 10 years. However, the analysis also suggests that slight improvement of the connections, e.g. use of proper/more number of nails, significantly reduce the probabilities of the collapse as well as other damages.

#### References

1. [REF] Nishijima, K., Nishimura, H., Tomisaka, K. and Namigishi, A. (2015), Evaluation of wind resistant performance of a non-engineered building in the middle of the Philippines, Part 1 – 3, *Summaries of technical papers of annual meeting Architectural Institute of Japan*, pp. 199-204.

# CHAPTER 5

## DISSEMINATION OF TECHNOLOGIES

### 5.0 Contents and Outline of Chapter 5

Dissemination of technologies on non-engineered housing is a very tough task, as that of engineered housing does not usually work effectively. Therefore, activities specifically suited to non-engineered housing must be designed. To address this issue, various organizations, such as international organizations, donors and NGOs along with researchers have been trying various approaches. This chapter presents an overview of the issue and analyzes typical activities. (in Section 5.1) Then, the typical tools of technical guidelines are introduced, as in 5.2; voluntary/informal guidelines, 5.3; guidelines of masonry structures in developed countries, such as the US, EU and Japan, and 5.4; official/formal guidelines in some developing countries. The outline of each section of this chapter is as follows:

#### Several Approaches for Dissemination

This section explains the major stakeholders concerning non-engineered houses and the relationship among

them, in comparison with those stakeholders concerning engineered houses (for which most countries have official institutions, and with which many readers are familiar). Based on a chart representing the stakeholders and their relationship, possible approaches on this issue are presented in five groups, in two categories, with typical examples in the attached example sheets.

#### Technical Guidelines

Technical materials are basic tools to disseminate technical knowledge to societies. This section provides an overview and introduces two complete and useful sources of technical information/knowledge for the creation of technical guidelines: the Guideline for Earthquake Resistant Non-engineered Construction, by the International Association for Earthquake Engineering (IAEE), and UNESCO, and World Housing Encyclopedia (WHE), by the Earthquake Engineering Research Institute (EERI), and IAEE.



### Formal Guidelines for Masonry

Much of the non-engineered construction is categorized into masonry structures, such as brick masonry and stone masonry. Masonry structures are one of the most common types of structure, worldwide. As such, many countries have official technical guidelines, which could be a useful resource of technical knowledge for technical guidelines for non-engineered construction. From this point of view, this section provides a typical formal technical guideline of the US (International Building Code (IBC) ) and the EU (Euro Code). The Japanese code on masonry is explained as well.

### Official Guidelines on Non-Engineered Construction

Most technical guidelines explained in 5.2 are informal/ voluntary. However, there are several official technical guidelines in developing countries (shown in this section). The experience of Japan regarding formal guidelines on conventional wood houses, which was categorized as non-engineered when the guideline was developed in 1950, is also provided.

## 5.1 Several Approaches for Dissemination

### Analysis of Stakeholders and Typology of Approaches

#### Introduction

This section clarifies the differences concerning dissemination activities between engineered and non-engineered houses based on an analysis of the relevant stakeholders (users/residents, housing supply sectors, and governments) and the relationship among them. Then, projects and initiatives consisting of activities for dissemination are classified into five groups, in two categories. Typical examples of each group are provided in the attached example sheets.

### Stakeholders in the construction of housing: Engineered housing

Engineered housing is constructed by the housing supply sector, with the investment of the users. The housing supply sector is comprised of architects, engineers, manufacturers of materials, and construction workers. Another important stakeholder group is governmental organizations, such as the central government and implementing agencies of building administration, such as municipalities. Housing supply sector and the governmental organizations both have technical knowledge, which works as a common platform for communication. Most of the dissemination and the capacity development activities are conducted on this platform. The relationship among them is illustrated in Figure 5.1.1.

Fig. 5.1.1 The relationship among stakeholders of engineered housing

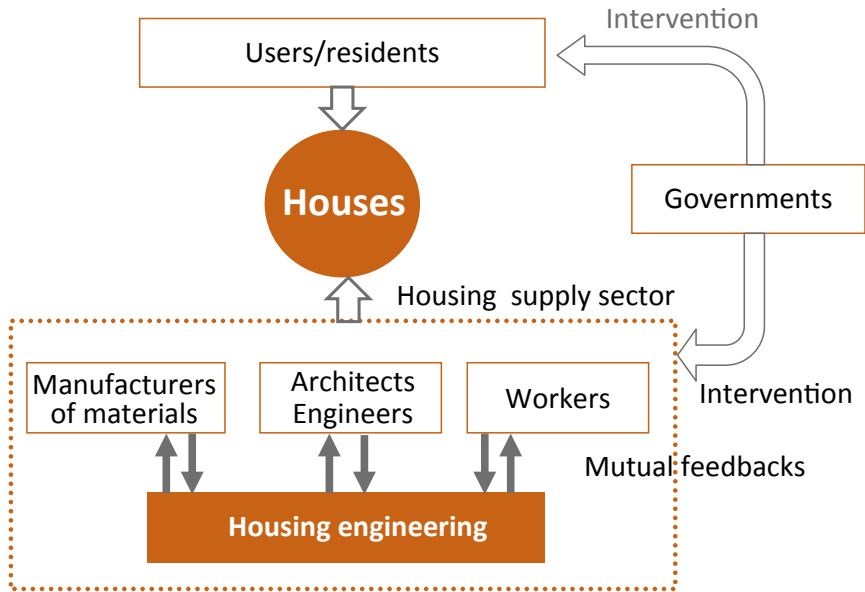

### Stakeholders in construction of housing: Non-engineered housing

The situation of non-engineered housing is much different from that of engineered housing. (See Figure 5.1.2) Most stakeholders in the housing supply sector of non-engineered housing reside in the same community as, or in a neighboring community of the users/residents. Construction materials, such as brick and lumber are produced by local manufacturers, usually without any quality control. Workers also reside in the same area. It is common for a project foreman to also be from the same community and to assemble a construction team by employing people in his neighbourhood (often with little experience in construction work). In the case of traditional housing in remote areas, such as housing made of sun-dried brick (adobe), most of the

work is conducted by family members, including adobe manufacturing, collecting materials, such as wood and those for roofing. These activities are usually done in rural areas, where the occupational/professional services of construction work are not available, due to the small size of these markets. Another aspect of this situation is an economic one; people who construct this type of housing are usually of low income and cannot afford to hire contractors or engineers.

In most countries, professional engineering services are available for large-scale buildings and housing for people who earn a good income. This implies that there exists a gap between those services and those for non-engineered houses, which is illustrated in Figure 5.1.2. Many governments do not have an effective way to intervene. In some

cases, NGOs support those people, usually with a component of comprehensive types of projects, such as community development or empowerment.

Table 5.1.1 shows a comparison of the aspects/items of non-engineered housing and engineered ones. It should be understood that seismic technologies for non-engineered housing should be 1) simple enough for non/semi-skilled

workers to understand and employ with a limited availability of tools and facilities on construction sites, 2) affordable enough for low/middle income users who must pay additional costs for safety. Concerning dissemination and capacity development, it is quite critical that workers are non/semi-skilled and that there is little/no intervention by engineers. This means that there exists no platform on which the case of engineered houses strongly relies.

Fig. 5.1.2 Stakeholders and the relation “engineered houses”

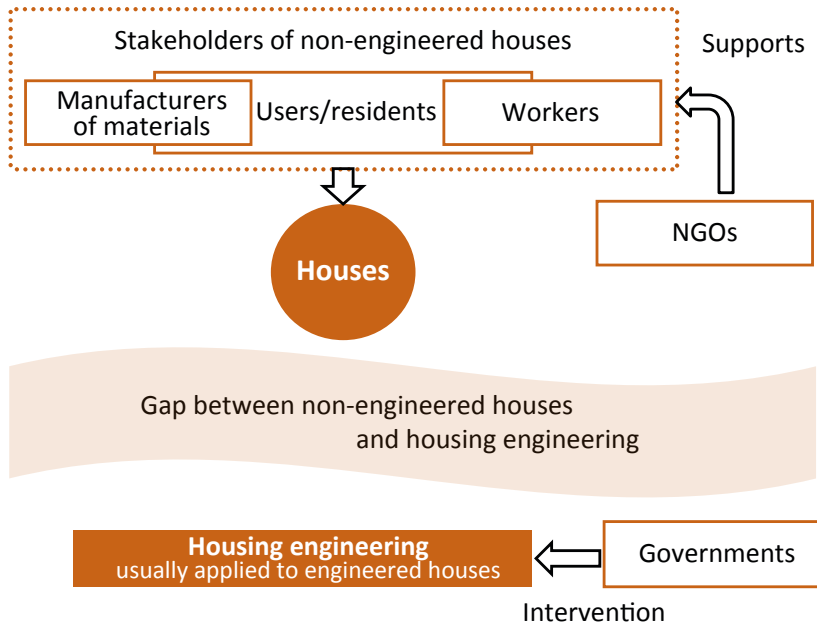

Table 5.1.1 Comparison of engineered and non-engineered construction

Aspects/items	Conventional/ non-engineered	Engineered
Materials	Available in the area No control	Usually controlled in size, quality, etc.
Construction workers	Non/semi-skilled workers	Skilled workers
Technical intervention	No/little intervention	Intervention in design, construction procedures, etc.
Users/residents	Low/middle income people	Middle/high income people
Users/residents	Low/middle income people	Middle/high income people

## Possible channels for dissemination and capacity development

Various approaches conducted by donors and NGOs are categorized based on the relationship of the stakeholder.

(Figure 5.1.2) The categorization is shown in the table below, which has five groups, in two categories. Each of the groups is described with examples in the following sub-sections:

Categories	Groups (Number of Figures of Illustrations)
A. Direct approach	a. Approaches for users/residents (Figure 5.3)
	b. Approaches for workers (Figure 5.3)
B. Indirect approach	a. Approaches through engineering community (Figure 5.4)
	b. Approaches through governmental organizations (Figure 5.5)
	c. Approaches through NGOs (Figure 5.6)

### A. Direct approaches to users/residents and workers (See Figure 5.1.3)

Distribution of leaflets and posters, seminars, workshops, and training programs for users/residents and workers are categorized into this group. This group could have direct effects and responses from participants (the final users to employ the technologies). On the other hand, diffusion from the participants to other people (the trickle-

down effect) is limited because they are the final users. Therefore, there needs to be other strategies for scaling up effects of dissemination. In this context, the ToT approach (The training of trainers, who are then expected to train trainees in later steps.) is widely adopted. It must be noted that for people without technical knowledge the curricula of training, textbooks and other materials should be user-friendly.

Fig. 5.1.3 Direct approaches to users/residents and workers

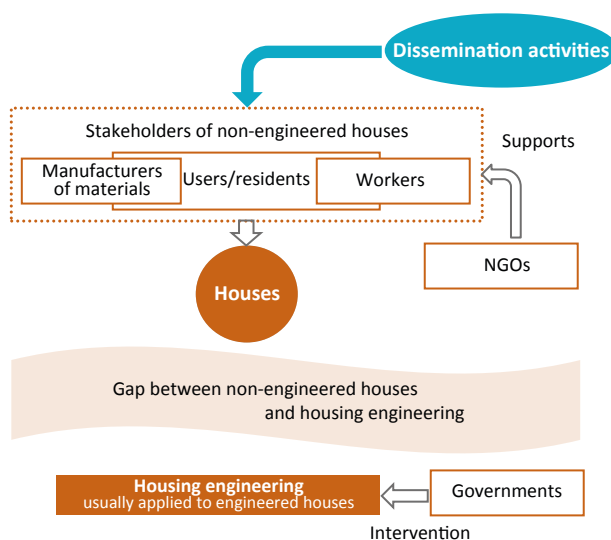

**a. Approaches for users/residents**

Distribution of leaflets or holding seminars for users to recognize the significance and the effects of seismic technologies are normal activities within this approach. The awareness of the risks by people is rather difficult in the case of earthquake disasters because of long returning periods. For the easy understanding of risks and effects, demonstrations that allow people to experience various types of activities are provided. (See Example No. 1) Activities for housing facilitators (young engineers or students employed in community-based type-projects to facilitate the construction of housing by people in the community) is also categorized into this group. (See Example No. 2)

**b. Approaches to workers**

Workers are the people who actually apply seismic technologies in construction works. Therefore, in addition to lectures in classrooms, practical ways, such as training to teach construction skills is often conducted, as well. (See Examples No. 3 and No. 4).

**B. Indirect approaches through engineering communities, governmental organizations and NGOs****a. Approaches through engineering communities (See Figure 5.4)**

It is common that few engineers or researchers are involved in non-engineered housing because engineers are not well paid for their technical services and researchers are seldom highly respected by their students. Under these circumstances, dissemination activities for the engineering community to recognize the significance of non-engineered housing for disaster mitigation in their own countries are essential as a first step. Engineers in every country must be key stakeholders because they could contribute far more than engineers from outside of their country. Publications such as housing reports and tutorials by the World Housing Encyclopedia (WHE) and "Guidelines for Earthquake Resistant Non-Engineered Construction" introduced in following division (5.3 Technical Guidelines), could play a role in this approach if read by engineers. It is recommended to show how to overcome the gap between engineered- and non-engineered housing (Shown in Figure 5.1.4) because most people in the engineering community have little knowledge of, or experience with, this issue.

Fig. 5.1.4 Approaches through engineering communities

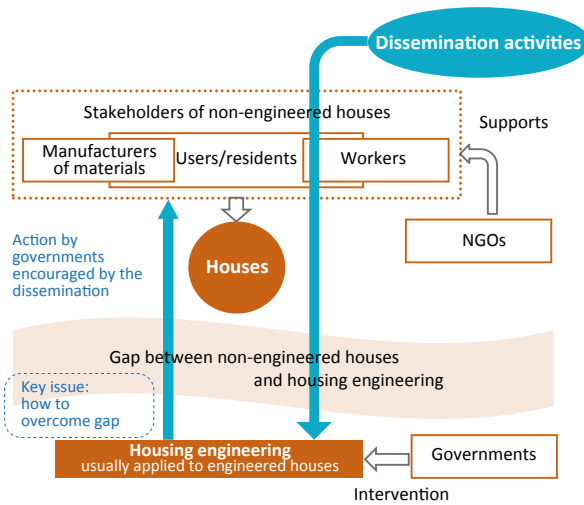

#### b. Approaches through governmental organizations (See Figure 5.1.5)

Governmental organizations are major actors regarding engineered structures, in ways such as development of technical guidelines/codes and implementation of building permits. For non-engineered housing, they are also expected to play an important role, even though the circumstances are much different and far more difficult. There are several options regarding activities, such as for users, workers, the engineering community and NGOs. Similar to the case of the approach through engineer communities described in the previous sub-section, it is recommended to show how to overcome the gap between engineered and non-engineered housing. An example in El Salvador (See Example No. 5) takes the approach to follow a similar way with engineered housing. In the project, an expert team made up of people from Japan and Mexico supported experts in El Salvador and the government in developing official technical guidelines for non-engineered housing. There is a case from Indonesia (See Example No. 6)

in which a similar approach was taken. The Indonesian project was implemented with reconstruction procedures from the Central Java Earthquake, of 2006. It was featured by the creation and adoption of very simple guidelines, applied only to one-story houses. In the implementation stage, administrative support for local governments in enforcing the guideline was also provided. The United Nations Center for Regional Development (UNCRD) conducted a project to provide comprehensive support to governments in accordance with the necessities of each county (See example no. 7).

It should be noted that the effects of this approach depend on policies of decision makers, such as presidents, ministers, governors, mayors and so on. If decision makers are supportive of poor people, a bigger contribution will be realized through this approach. Sustainability needs to be considered for cases of changes of policies or replacement of policy makers due to elections or other reasons.

Fig. 5.1.5 Approaches through governmental organizations

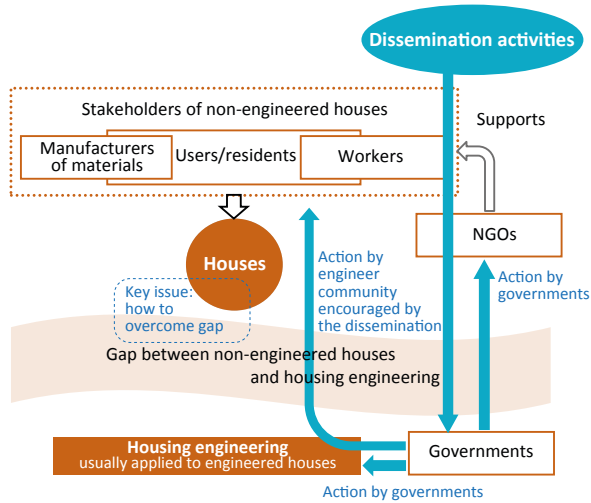

c. Approaches through NGOs (See Figure 5.6)

Most NGOs conduct grass-roots type projects, thus they have close relationships with people and communities, which means that there is no gap for them to overcome. Considering this aspect, they are appropriate stakeholders for dissemination activities

for non-engineered housing. On the other hand, they have problems in scaling up, just as in the direct approach stated in 3.4.1. Example no. 8 shows this approach, even though dissemination is indirect (from the donor (JICA), to NGOs through participants (the trainees in the JICA project) and unplanned.

Fig. 5.1.6 Approaches through NGOs

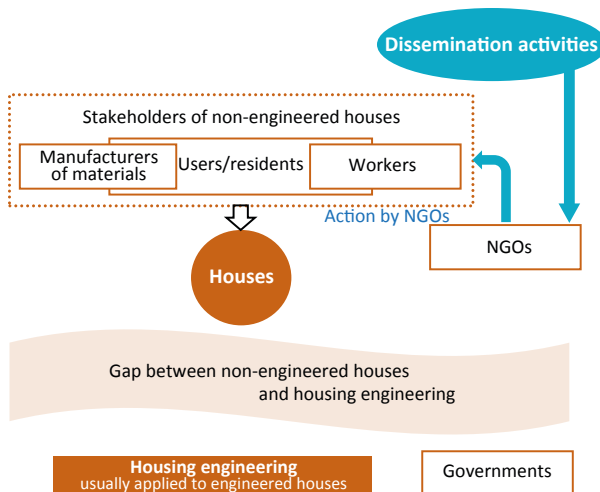

## Concluding remarks

Dissemination and capacity development activities on non-engineered housing are far more difficult than those for engineered housing because stakeholders who are directly involved in construction have neither technical knowledge nor a common platform of communication. Furthermore, this issue includes difficulties that are common to “poverty reduction” efforts, the common goal of the international donor community, as most users are in low income groups so they are not able to invest enough in safety. In spite of the difficulties, several relevant organizations and donors have been conducting various projects, as mentioned in previous sub-sections. There is no common, single solution on this issue. It is necessary to draw lessons from the experiences and to create effective strategies that are appropriate to the social-, economic- and political situations of each county.

## References

1. Tatsuo Narafu, Akihiko Tasaka, Matsuzaki Shizuko, Hiroshi Imai, Keiko Sakoda, Hiroto Hosaka, Junzo Sakuma, Ryunosuke Okamoto, Lessons on Dissemination of Technologies of Seismic Non-engineered Housing -A

Case Study of a Training Program in Peru, Proceedings of TERRA 2012, XI International Conference on the Study and Conservation of Earthen Architecture Heritage, April 2012, Lima, Peru

## Attached Example sheets

- No. 1 Demonstration and explanation of simple shaking-table test in Banda Aceh
- No. 2 Lectures for housing facilitators in Banda Aceh
- No. 3 Dissemination on Construction Technology for Low-Cost and Seismic Resistant Housing in Peru
- No. 4 Architectural Mobile Clinic by SNS
- No. 5 The enhancement of the construction technology and dissemination system of the earthquake-resistant “vivienda social”
- No. 6 Development of a simple technical guideline for one-story houses and its enforcement in Central Java, Indonesia
- No. 7 Housing Earthquake-Safety Initiative (HESI) by UNCRD
- No. 8 Diffusion of technologies through NGOs in Peru



## Example sheets for dissemination of seismic design

No. 1

Project title	Demonstration and explanation of simple shaking table test (A component of Multidonor Fund, Community-based Settlement Reconstruction and Rehabilitation Project (MDF-CSRRP))	Author	Tatsuo Narafu
		Affiliation, contact address	Japan International Cooperation Agency (JICA) Narafu.Tatsuo@jica.go.jp
Implementer	The World Bank/Building Research Institute (BRI)/National Society for Earthquake Technology (NSET), Nepal	Targeted group	people and communities
Country/Region	Aceh, Indonesia	Duration	2006
Structural types	Confined brick masonry	Reference	<a href="http://www.nset.org.np/nset2012/index.php/photo_gallery/type-picture/galcategoryid-34NA">http://www.nset.org.np/nset2012/index.php/photo_gallery/type-picture/galcategoryid-34NA</a>
Type of activities	<input type="checkbox"/> publications <input checked="" type="checkbox"/> seminars/workshops	<input type="checkbox"/> training	<input type="checkbox"/> others (                      )

**<Background information>**

Aceh, Indonesia is one of the most heavily damaged areas by the Indian Ocean Earthquake and Tsunami in 2004. Many international organizations, donors and NGOs participated in reconstruction from the disaster. The activities in this sheet are components of a multidonor fund project managed by the World Bank.

**<Outline of activities>**

Demonstrations to show people and communities how great the difference is between resilient and vulnerable houses. Two scale model houses (1/10) were prepared for the demonstration. One was constructed of proper construction and the other was poorly constructed.

Both were shaken on a simple shaking table actuated by springs. As shaking motion became stronger and stronger, the one of poor construction became increasingly more damaged, while the one of good construction suffered little damage. Along with the demonstration, experts explained the various causes and reasons of vulnerability in an easy way for participants to understand. Through the demonstration and explanation the audience clearly understood the difference between the two models and the significance and the effect of seismic resilience of houses.

**<Impact and evaluation>**

The audience seemed fascinated by the demonstration, and they understand the message that organizers wanted to convey. They were convinced of the significant difference that seismic resilience makes in houses.

**<reference>**

Detail of 1/10 scale model house of confined brick masonry



Two scale model houses (1/10), and an expert/lecturer, surrounded by audience



The model house of poor construction sustained more and more damage as shaking motion became stronger.



The audience members were very interested, and many took photos



The final stage of the demonstration: The model house of poor construction totally collapsed.

## Example sheets for dissemination of seismic design

No. 2

Project title	Lectures for housing facilitators ( A component of Multi Donor Fund, Community-based Settlement Reconstruction and Rehabilitation Project (MDF-CSRRP))	Author	Tatsuo Narafu
		Affiliation, contact address	Japan International Cooperation Agency (JICA) Narafu.Tatsuo@jica.go.jp
Implementer	The World Bank/Building Research Institute (BRI)	Targeted group	housing facilitators who support people and communities
Country/Region	Aceh, Indonesia	Duration	2006
Structural types	Confined brick masonry	Reference	NA
Type of activities	<input type="checkbox"/> publications <input checked="" type="checkbox"/> seminars/workshops	<input type="checkbox"/> trainings	<input type="checkbox"/> others (                    )

**<Background information>**

Aceh, Indonesia is one of the most heavy damaged areas by the Indian Ocean Earthquake and Tsunami 2004 and many international organization, donors, and NGOs participated in reconstruction from the disaster. The activities in this sheet y are components of a multi donor fund project managed by the Word Bank.

**<Outline of activities>**

In reconstruction from the disaster, the World Bank took community-based approach and encourage people and community to reconstruct their houses by themselves with support both in technical and social by the Bank.

Recovery from damage by people and family has various aspects like job/income opportunity, physical and mental health, education, shelter and living environment, etc. In order to support recovery of people and family, the bank employed young experts and students for consultation with individual people/family.

Those people are called "facilitators". Housing facilitators are one of those facilitators to help people and community to reconstruct houses and community facilities like foot paths, etc. with their expertise. Most of them are young architects, engineers or students of the expertise. The housing facilitators worked in close relation with people. In addition they have certain level of technical knowledge. Therefore they could be good media in receiving technical information, translating it into easy expression and delivering to people. The Bank and BRI organized lectures for the housing facilitators. As most of them were young and did not have enough practical knowledge, lectures allotted much time for knowledge on practice on site including actual materials and tools.

**<Impacts and evaluation>**

The facilitators were highly motivated to support affected people to recover from tragic natural disaster. They are enthusiastic to learn knowledge which was new for them. They played essential role in this community-based project.



A lecture in a classroom



Lecture on a simple test on quality of aggregates for concrete



Lectures on samples of various kinds of aggregate for concrete which are available in Aceh and neighboring area



Exercise of simplified concrete slump test with a PET bottle

Example sheets for dissemination of seismic design

No. 3

Project title	Dissemination of Construction Technology for Low-Cost and Seismic Resistant Houses		Author	Tatsuo Narafu
			Affiliation, contact address	Japan International Cooperation Agency (JICA) Narafu.Tatsuo@jica.go.jp
Implementer	JICA/CIDAP(Peruvian NGO)/SENCICO		Targeted group	Workers (dwellers)
Country/Region	Peru		Duration	2004-2010
Structural types	Adobe		Reference	NA
Type of activities	<input type="checkbox"/> publications	<input type="checkbox"/> seminars/workshops	<input checked="" type="checkbox"/> training	<input type="checkbox"/> others ( )

<Background information>

Adobe is one of the most vulnerable types of housing, for which construction is usually done by residents themselves. Several methods for reinforcing adobe structures are proposed. This project employed a method proposed by Peruvian researchers using canes in both the vertical and the horizontal direction and wood beams on top of adobe walls (cf. figure)



Adobe houses destroyed by Pisco EQ 2007

<Outline of activities>

Dissemination of the seismic design and construction skills for workers (residents in this case) by training through constructing actual houses. The training programs of the project were implemented by a Peruvian NGO (CIDAP) in cooperation with municipalities and SENCICO (Peruvian governmental organization). The training was composed of 1)lectures (technical workshops) on design and construction works of each stage of total construction procedures (re: photo) and 2)construction work to build actual houses under the guidance of engineers from the NGO (cf. photo). The total number of houses constructed in the project was 12, and there were about 20 people who participated in construction of one of the houses.

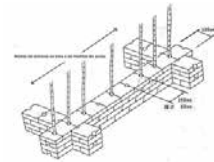

Reinforcement of walls (vertically placed canes)

<Impacts and evaluation>

According to the results of questionnaires to participants, most of them thought that they could learn the seismic design and were willing to apply it to their own houses. The design was proven to be resilient enough in the Pisco EQ 2007, as the houses from the project suffered little damage, whereas most of the neighboring houses were heavily damaged. The design was employed by international NGOs in community development projects for improving living environment and around 10 houses were constructed. A mayor of one of the project sites applied the design to small municipal buildings, such as community health care centers, a consulting office, and so on, and around 10 buildings were completed.



Technical workshop



Constructing works  
Training program in Peru

Reference

Tatsuo Narafu et al. "LESSONS ON DISSEMINATION OF TECHNOLOGIES OF SEISMIC NON-ENGINEERED HOUSES -A CASE STUDY OF A TRAINING PROGRAM IN PERU-", XIth International Conference on the Study and Conservation of Earthen Architectural Heritage, Terra 2012, Lima, Peru

Training Schedule

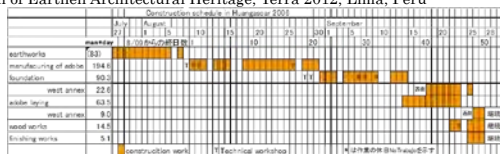

## Example sheets for dissemination of seismic design

No. 4

Project title	Architectural Mobile Clinic by SNS		Author	Hiroshi IMAI (SNS/NIED)
			Affiliation, contact address	Mohri Architects & Associates. Inc, imai @mohri-aa.co.jp
Implementer	SNS International Disaster Prevention Support Center Japan, Funded by Japan Platform		Targeted group	Masons, Communities
Country/Re- gion	Yogyakarta, Padang Pariaman, Indonesia		Duration	2007-2010
Structural types	Confined brick masonry		Reference	
Type of activities	<input checked="" type="checkbox"/> publications	<input checked="" type="checkbox"/> seminars/workshops	<input checked="" type="checkbox"/> training	<input type="checkbox"/> others ( )

**<Background information>**

The Central Java Earthquake occurred in Yogyakarta province on May 27 2006, killing 5,716 people and causing heavy damage or complete destruction to 175,687 houses. And in the Padang Earthquake on September 30 2009, more than 1,100 people were killed and around 110,000 houses were either totally destroyed or heavily damaged. The major cause for a large number of the casualties was damage to non-engineered construction.



Training for masons in Padang Pariaman

**<Outline of activities>**

SNS International Disaster Prevention Support Center Japan conducted the "Architectural Mobile Clinic Project", as stated below. Based on survey results on damaged buildings and an analysis, SNS organized activities for reconstruction of houses, repair of damaged houses and retrofitting of houses in the community, as follows:

1. Training for masons and workers, to provide them with technical knowledge and to teach them skills for the construction of safer masonry houses
2. A seminar for people/users, to provide them with the basic knowledge of safe houses and to raise awareness of the risks of earthquakes.
3. Published a manual on safe houses and a retrofitting method for masons

This manual was developed through monitoring of training activities, discussions with the masons and construction workers with the UGM POSYANIS (local NGO), organized by SNS International and funded by the Japan Platform.



Seminar for people in Padang Pariaman

**<Impacts and evaluation>**

SNS conducted questionnaire surveys on each of trainings. The participants answered that they needed very basic knowledge and practical training. The content of the training met their needs and it is believed that it had a positive impact.



Publication : Retrofitting manual,  
Yogyakarta, 2007



Publication : Safer construction,  
Padang Pariaman, 2010



Publication : Safer construction,  
Padang Pariaman, 2010

Example sheets for dissemination of seismic design

No. 5

Project title	The enhancement of the construction technology and dissemination system of the earthquake-resistant "vivienda social"	Author	Naomi Honda
		Affiliation, contact address	
Implementer	JICA/Vice Ministry of Housing and Urban Development of El Salvador <sup>*1</sup>	Targeted group	Officials, Builders, Engineers
Country/Re-gion	El Salvador	Duration	2009-2012
Structural types	Improved Adobe, Concrete Block, Confined masonry with Soil Cement, Block Panel	Reference	NA
Type of activities	<input checked="" type="checkbox"/> publications <input type="checkbox"/> seminars/workshops	<input type="checkbox"/> training	<input checked="" type="checkbox"/> others (official standards)

<Background information>

Two earthquakes in 2001 caused serious damage to many buildings in El Salvador, especially houses of low-income groups. For the first step of the project, an experimental study on earthquake-resistant low-cost houses was carried out from 2003 to 2008, supported by JICA. Based on the achievement of the abovementioned project, a new JICA project was started in 2009 for development of drafts of 3 official technical standards and 1 technical manual on low-cost houses.



Adobe houses destroyed by EQ, 2001

<Outline of activities>

Four types of houses were selected, which are, or expected to be widely used in the future, by low income groups. The project was implemented by the Vice Ministry of Housing and Urban Development in cooperation with 2 universities and 2 institutions related to housing construction. They conducted the necessary research and drafted 3 technical standards (Improved Adobe, Concrete Block, Confined masonry with Soil Cement) and 1 technical manual (Block Panel)\*2. These drafts are characterized by the following:  
 1) they apply to small houses of, 50 sq m or less  
 2) specification based guidelines without structural calculation



Structural test

In addition, they organized several workshops for local officials in charge of building permits and made brochures for the public for dissemination of the technology.

<Impact and evaluation>

A technical manual for Block Panel was published officially by the Vice Ministry of Housing and Urban Development in October 2010. Technical standards of Concrete Block and Confined Masonry with Soil Cement were enforced in 2014. The technical standard of Improved Adobe was also formalized in 2014. These achievements are expected to be applied in actual construction projects in El Salvador. Moreover, they are expected to be diffused to other parts of Central and South America.



Reporting about the technical standard

Notation

\*1: In El Salvador, every ministry has several "vice ministries". For example, the Ministry of Public Works, Transport, Housing and Urban Development has three vice ministries and the Vice Ministry of Housing and Urban Development is one of them.  
 \*2: Block Panel was developed in Cuba and adopted by a few organizations in El Salvador, therefore it was determined that Block Panel didn't require general standards.



Workshop for local officials



Workshop about in Adobe in Honduras



Brochures for the public

## Example sheets for dissemination of seismic design .

No. 6

Project title	Development of simple technical guideline for one-story houses and its enforcement (A component of "Technical Cooperation Project for Reconstruction from Central Java Earthquake")		Author	Tatsuo Narafu
			Affiliation, contact address	Japan International Cooperation Agency (JICA) Narafu.Tatsuo@jica.go.jp
Implementer	Japan International Cooperation Agency (JICA)		Targeted group	Provincial government
Country/Region	Special Province of Yogyakarta, Indonesia		Duration	2006-2007
Structural types	Confined brick masonry		Reference	NA
Type of activities	<input type="checkbox"/> publications	<input type="checkbox"/> seminars/workshops	<input type="checkbox"/> training	<input checked="" type="checkbox"/> others( )

**<Background information>**

The Central Java Earthquake 2006 (M:6.3 UNOSAT) killed 5,715 people, injured about 50,000 and caused the collapse of more than 100,000 houses, most of which were non-engineered. In order to rebuild from the disaster, the Indonesian government decided to provide subsidies for people to reconstruct their own houses. The government took this opportunity to make non-engineered houses resilient against future earthquakes. At that moment legal scheme of building permit existed but did not work well for non-engineered houses. They had a technical guideline for seismic design, which was suitable for engineered construction but too complicated for small, one-story houses. Under the situation, most of those houses were constructed without building permits not complying to technical guidelines. Therefore, a JICA team of experts supported the local government of the Special Province of Yogyakarta to develop a simple technical guideline for one-story houses and to make building permit scheme work well to enforce the guidelines.



technical guideline, "Key Requirements" to people



A consulting office for people to help them prepare documents and apply for building permits

**<Outline of activities>**

Development of a simple technical guideline, "Key Requirements", applicable to small, one-story houses. The "Key Requirements", consisting of 12 requirements, made it far simpler than the official technical guideline on seismic design.

Leaflets and posters on the Key Requirements were prepared and distributed. A series of seminars were also organized.

Another important pillar of activities is establishment and capacity development of an implementation body. For this purpose, a series of seminars and training sessions for governmental officials of the Province were organized to develop their capacity to manage the procedures beginning with the acceptance of applications for building permits, processing in the relevant sections, examination of application documents, and finally the issuing of permits. Since low-income people are not familiar with official procedures to prepare documents and submit them, consulting offices were set up for the convenience of applicants where people could receive all kinds of advice.



A seminar for capacity development of government officials in charge of building permits

**<Impacts and evaluation>**

Reconstruction of houses is quite urgent, as they are basic infrastructure for the lives of the affected people. Overall, the reconstruction procedures were satisfactory in meeting the urgent needs of the people. Flexible management contributed to this in such a case when applicants promised to submit application later, they were allowed to start construction and provided with the subsidy. The capacity of the local government officials to help people prepare application documents and process them was not sufficiently developed in spite of various activities to prepare them..

Example sheets for dissemination of seismic design

No. 7

Project title	Housing Earthquake Safety Initiative (HESI)	Author	Shoichi Ando, Jishnu Subedi, Hayato Nakamura (2007-2010, UNCRD Hyogo)
		Affiliation, contact address	National Graduate Institute for Policy Studies (GRIPS), <a href="mailto:ando@grips.ac.jp">ando@grips.ac.jp</a>
Implementer	Disaster Management Planning, Hyogo Office, United Nations Centre for Regional Development(UNCRD), NSET-Nepal, CISMID-UNI-Peru, ITB-Indonesia etc.	Targeted group	government officers and communities
Country/Region	Nepal (Kathmandu), Peru (Lima), Indonesia	Duration	2007-2010
Structural types	Confined brick masonry, RC and others	Reference	<a href="http://www.uncrd.or.jp/index.php?menu=229">http://www.uncrd.or.jp/index.php?menu=229</a>
Type of activities	<input checked="" type="checkbox"/> publications <input checked="" type="checkbox"/> seminars/workshops	<input checked="" type="checkbox"/> training	<input type="checkbox"/> others ( )

<Background information>

The collapse of buildings causes major tragedies in earthquake-related disasters. In order to achieve resilient social infrastructures, through earthquake resistant buildings, cooperation of engineers and governments is essential. Though many earthquake prone countries now have building codes, there is a serious challenge for effective implementation of the building code and retrofitting policy because of a lack of awareness and of an institutional mechanism.

<Outline of activities>

The United Nations Centre for Regional Development (UNCRD) Disaster Management Planning, Hyogo Office, launched the Housing Earthquake Safety Initiative (HESI) Jan. 2007-2010, and conducted various activities throughout the three target countries. UNCRD aimed an international information exchange platform to share policies. The project aided at improvement of the safety of houses against earthquakes through effective implementation of building codes and a retrofitting policy. The activities included gap analysis of perception and implementation in the target countries, raising awareness and capacity development among stakeholders, developing policy recommendations, guidelines and dissemination on improving building-safety regulations.

<Impact and evaluation>

Under this initiative, UNCRD prepared an international information exchange platform to share policy experiences. Several effective tools to reduce or prevent damage by earthquakes were developed, which could be used in other countries.

It has been verified that effective building-code implementation requires not only capable national institutions for strict enforcement, but also the means to engage communities.

Reference

- HESI and SESI publications: <http://www.uncrd.or.jp/index.php?menu=229>
- HESI int'l sympo. 2008: <http://www.uncrd.or.jp/content/documents/From%20Code%20to%20Practice.pdf>
- HESI Handbook, Nepal, 2008: <http://www.uncrd.or.jp/index.php?page=view&type=400&nr=156&menu=229>
- HESI Peru WS, 2007: <http://www.uncrd.or.jp/index.php?page=view&type=400&nr=176&menu=229>
- HESI Indonesia Guide, 2009: <http://www.uncrd.or.jp/index.php?page=view&type=400&nr=155&menu=229>



HESI Conference in Peru, 2007 at UNI-FIC CISMID (Japan-Peru Seismic DM Center)



Field Visit with experts and policy makers at HESI event in Nepal, 2007



Publications on HESI projects, officers/engineers training guideline for Nepal (upper), Building code implementation Indonesian guideline (lower) in 2007-09

Concept and related fields of "Housing Earthquake Safety", including building codes



Awareness event on "Earthquake Day" of Nepal, 16 January, 2008 (NSET & UNCRD)



## Example sheets for dissemination of seismic design

No. 8

Project title	Diffusion of technologies through NGOs		Author	Tatsuo Narafu
			Affiliation, contact address	Japan International Cooperation Agency (JICA) Narafu.Tatsuo@jica.go.jp
Implementer	Caritas, CRS(International NGO)/JICA (indirect)		Targeted group	NGOs
Country/Region	Peru		Duration	2008-2010
Structural types	Adobe		Reference	NA
Type of activities	<input type="checkbox"/> publications	<input type="checkbox"/> seminars/workshops	<input type="checkbox"/> training	<input checked="" type="checkbox"/> others ( )

**<Background information>**

JICA conducted a project, "Dissemination on Construction Technology for Low-Cost and Seismic Resistant Houses" from 2004-2010, constructing 12 model houses in 8 municipalities for OJT (on-the-job training) purpose. (re: Example sheet No.3) Huangascar, Yauyo Province, Lima State, was selected as one of the project sites of a rural-area development project by NGOs, consisting of agricultural productivity improvement, construction of irrigation facilities, community governance, and housing improvement by Caritas and CRS(both are international NGOs).



A seismic adobe house being constructed in the rural area development project by the NGOs

**<Outline of activities>**

Former participants of a JICA project proposed that NGOs adopt the seismic adobe-house construction technology that they learned about in the project, and NGOs accepted it. It was reported that about 15 seismic adobe houses were constructed by the rural-area development project.



Former participants of the JICA dissemination project proposed to apply the seismic design to houses constructed in the NGO project

**<Impacts and evaluation>**

This is a good practice of spontaneous dissemination from the fact that the technologies were applied to houses outside of the dissemination project, although dissemination was indirect (via participants of the training course) and unplanned (JICA did not plan to disseminate to NGOs as it did not know Huangascar was going to be a project site of NGOs).

This case shows a high possibility of dissemination of technologies for low income groups through NGOs, as target groups of activities of NGOs are often low income groups and NGOs are good at having good relation with them. The possibility should be further explored in a more direct or planned manner.



A staff member of Caritas presenting the seismic adobe houses constructed in their project, at Terra 2012, an international conference in Lima, Peru

**<reference>**

Tatsuo Narafu et al. "LESSONS ON DISSEMINATION OF TECHNOLOGIES OF SEISMIC NON-ENGINEERED HOUSES -A CASE STUDY OF A TRAINING PROGRAM IN PERU-", XIth International Conference on the Study and Conservation of Earthen Architectural Heritage, Terra 2012, Lima, Peru

Left: A completed seismic adobe house in Huangascar, Yauyo Province, Lima State



Right: A house owner of a seismic adobe house with construction colleagues of, a leader of CIDAP and an engineer





## 5.2 Technical Guidelines

### 5.2.1 Overview

Technical materials are basic tools for disseminating technical knowledge to societies. Therefore, everyone implementing projects to enhance the safety of buildings prepares technical guidelines and distributes brochures, posters, etc., as shown in Figure 5.2.1. Most such guidelines are only applicable to that particular project, and may not be in complete compliance with the official technical guidelines of the country where the project is conducted. (“5.3 OFFICIAL GUIDELINES ON MASONRY AND NON-ENGINEERED CONSTRUCTION” shows several advanced examples.) Those

technical guidelines are created based on technical information from various sources, such as reports of field surveys on damaged buildings and analysis of the damage. When it comes to non-engineered construction, knowledge from experimental studies of materials, components and structures is also utilized, even though a considerable portion of such knowledge is an interpretation of knowledge of engineered structures. Among that technical information, two complete and useful sources which have been referenced worldwide are introduced in this section.

Figure 5.2.1 An example of technical guidelines (Manual for Earthquake Resistant Adobe Houses in Peru. Left: cover, right: an example of reinforcing with wire mesh)



### 5.2.2 Guideline for Earthquake Resistant Non-Engineered Construction

#### Brief history

The “Guideline for Earthquake Resistant Non-Engineered Construction” was

published by the International Association for Earthquake Engineering (IAEE) in 1986. It is a revised- and larger version of “Basic Concepts of Seismic Codes, Vol.1, Part II, Non-Engineered Construction”, also published by IAEE, in 1980. The revision resulted from the work of an ad-hoc

committee, integrated by Anand S. Arya, Chairman (India), Teddy Boen (Indonesia), Yuji Ishiyama (Japan), A. I. Martemianov (USSR), Roberto Meli (Mexico), Charles Scawthorn (USA), Julio N. Vargas (Peru) and Ye Yaoxian (China).

Three members of the committee for the 1986 edition, i.e. Anand S. Arya, Teddy Boen and Yuji Ishiyama, met in Tokyo, Japan during “The International Symposium on Earthquake Safe Housing”, which was held in 2008. Since more than twenty years had passed from the time of publication, the three members revised the Guideline with the help of a few international experts. The activities for the revision were done as volunteer work by three members and supported in part by UNESCO and the International Institute of Seismology and Earthquake Engineering (IISEE), Building Research Institute (BRI), JAPAN. It was completed and published in 2014 by UNESCO and introduced at the Third United Nations Conference on Disaster Risk Reduction, in Sendai, Japan, March 2015. (Figure 5.2.2)

### Outline of the Guideline

The Guideline consists of the following chapters:

1. The Problems, Objective and Scope
2. Structural Performance during Earthquakes
3. General Concept of Earthquake Resistant Design
4. Masonry Buildings of Fired-Brick and other Materials
5. Stone Buildings
6. Wooden Buildings
7. Earthen Buildings
8. Non Engineered Reinforced Concrete Buildings
9. Repair, Restoration and Strengthening of Buildings
10. Appendix

This shows the characteristics of the Guideline as 1) complete, beginning with basic knowledge (such as structural performance during earthquakes and the general concept of earthquake resistant design) to repair, restoration and strengthening, 2) comprehensive, covering various structures, such as brick and similar materials, stone, wood, earth and non-engineered reinforced concrete. The Guideline starts with a presentation of the basic concepts that determine the performance of structures when subjected to high intensity earthquakes, as well as the sensitivity of that performance to the basic geometrical- and mechanical properties of the systems affected. This information is later applied to the formulation of simplified design rules and to the presentation of practical construction procedures, both intended to prevent a system collapse and to control the level of damage produced by seismic activity. Emphasis is placed on basic principles and simple solutions that can be applied to different types of structural systems, representative of those ordinarily used in low-cost housing construction in different regions and countries around the world. Then, detailed explanations on various types of non-engineered construction, which cover most of the wide variety of non-engineered construction around the world. This can be downloaded from the UNESCO website:

[http://www.unesco.org/new/en/natural-sciences/about-us/single-view/news/new\\_guidelines\\_to\\_improve\\_the\\_safety\\_of\\_informal\\_buildings/#.VAT9a60Hh0o](http://www.unesco.org/new/en/natural-sciences/about-us/single-view/news/new_guidelines_to_improve_the_safety_of_informal_buildings/#.VAT9a60Hh0o).

Figure 5.2.2  
Cover of the Guideline by UNESCO

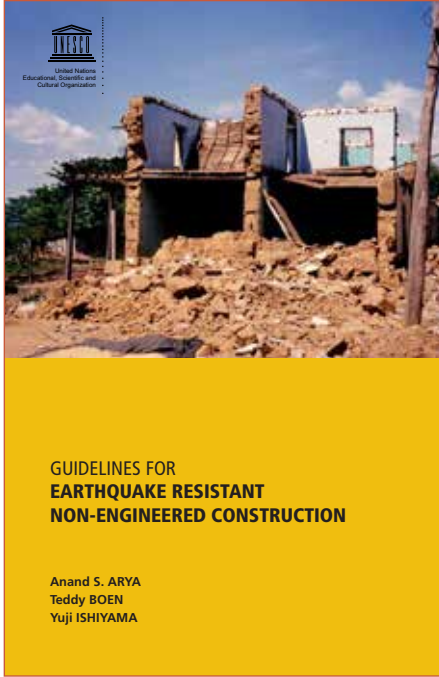
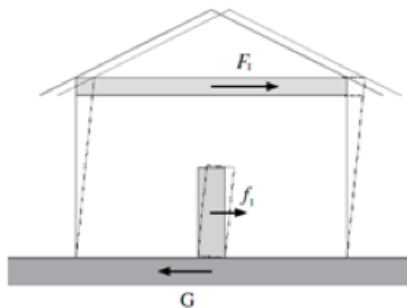

Figure 5.2.3 Typical damage to houses of undressed stone masonry with mud mortar, as shown in the Guideline (2005 Northern Pakistan Earthquake (Kashmir Earthquake)) Much typical damage to various types of structures are addressed



Figure 5.2.4 Many illustrations are provided for easy understanding (an example showing inertia force caused by earthquake ground motion)



$F_i$ : inertia force actions on the building  
 $f_i$ : inertia force on the content  
 G: ground motion

Figure 5.2.5 An illustration showing several types of damage in masonry buildings

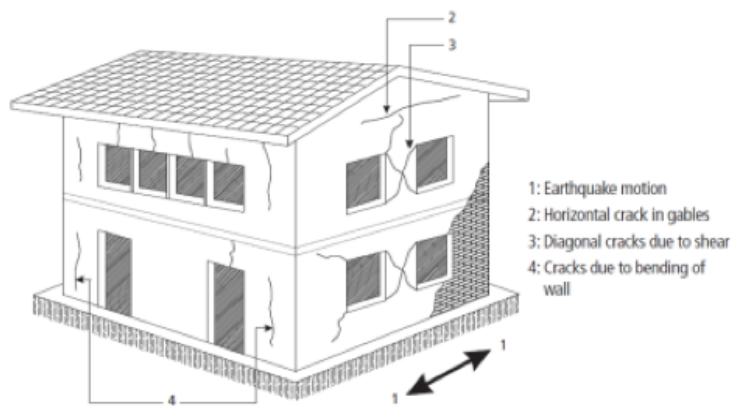
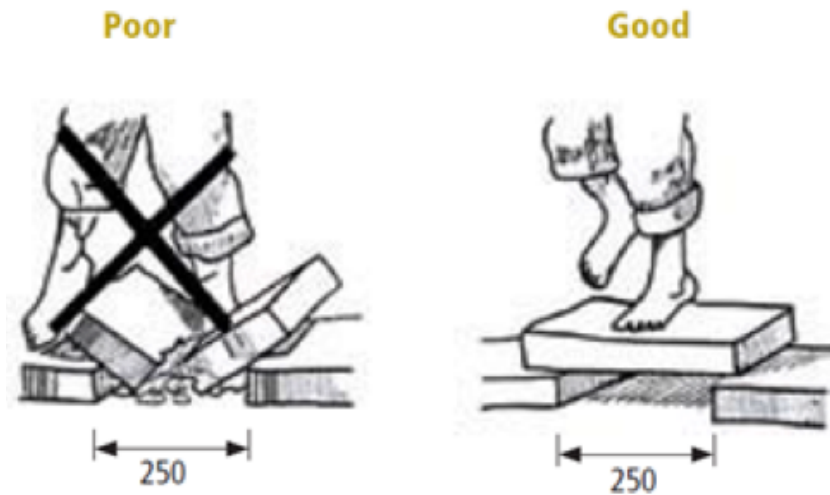

Figure 5.2.6 An illustration showing a simple and easy field test for strength of adobe



### 5.2.3 Initiative of the World Housing Encyclopedia

#### Outline of the initiative

The World Housing Encyclopedia (WHE) is an initiative of the Earthquake Engineering Research Institute (EERI) and the International Association for Earthquake Engineering (IAEE), to improve the seismic resistance of housing. Apart from the primary achievement of a web-based

housing database cum encyclopedia, numerous other on-line resources have been developed by WHE participants to provide technical guidance to developing countries. Such resources continue to be developed.

#### Brief history

The World Housing Encyclopedia (WHE) was founded at the 2000 World Conference on Earthquake Engineering under the

auspices of EERI and IAEE. It has two aims; the first is to develop a database of housing types from around the world. This task is well advanced, with reports on approximately 160 housing types, from 44 countries. The second aim is to produce technical guidelines, mainly for non-engineered construction, for architects and engineers in developing countries. The project is overseen by a voluntary executive committee and is supported by the part-time involvement of an EERI staff member.

### Features

The database is a global inventory of housing construction types. Reports of each are presented using a standardized format. All relevant aspects of housing construction are covered by the report, such as socio-economic issues, architectural features, the structural system, seismic deficiencies, earthquake-resistant features, performance in past earthquakes, available strengthening technologies, building materials used, the construction process and insurance. In addition to the text and numerical information, several illustrations (photos, drawings, sketches) are included in the report. All reports comprise a searchable database of global housing construction. Currently, the 160 reports included in the database describe housing construction practices from 44 countries or territories. Two examples of buildings in the database are shown in Figures 5.2.7 and 5.2.8.

For some construction types, this is one of the few, if not the only place where such detailed information is available in English. The framework created by this project provides an inexpensive and effective way for professionals in

many countries to share knowledge on construction practices and retrofitting techniques to improve earthquake-safety. The database, or encyclopedia as it is called, is an entirely on-line resource, accessible to anyone, at <http://www.world-housing.net>.

As well as the database, a range of other on-line resources has been developed for wide dissemination. Known generically as 'tutorials', they include publications on aspects of the seismic resistance of adobe (sun-baked mud block) and confined masonry buildings. Both of these publications are available in Spanish and English.

There are now a total of three WHE publications on confined masonry. Recent earthquakes in several countries have highlighted the poor performance of reinforced concrete frames with masonry infill. However, by making some simple changes to traditional construction materials and procedures, safe confined masonry structures can be achieved. Currently practiced throughout Latin America, the Mediterranean and the Middle East, and having generally performed well during seismic activity, this construction technology is being introduced to other countries, such as India.

Also focusing on the needs of developing countries, a major WHE publication on reinforced concrete frame buildings is "AT RISK: The Seismic Performance of Reinforced Concrete Frame Buildings with Masonry Infill Walls". Translated into Indonesian and Spanish, it addresses the technical challenges that this type of construction presents. Although used very extensively worldwide, this type of

construction contains significant inherent flaws, which are frequently exposed by earthquakes.

A tutorial on the layout and construction of stone buildings, titled "Improving the

Seismic Performance of Stone Masonry Buildings" is also available. All tutorials can be downloaded for free from the website. The covers of three publications are shown in Figures 5.2.9 – 5.2.11.

Figure 5.2.7 An adobe house in Nicaragua (Matthew French)



Figure 5.2.8 A confined block masonry building in Chile. From a report by Moroni, O. Gomez, C and Astroza, M.



Figure 5.2.9 One of three publications on confined masonry housing

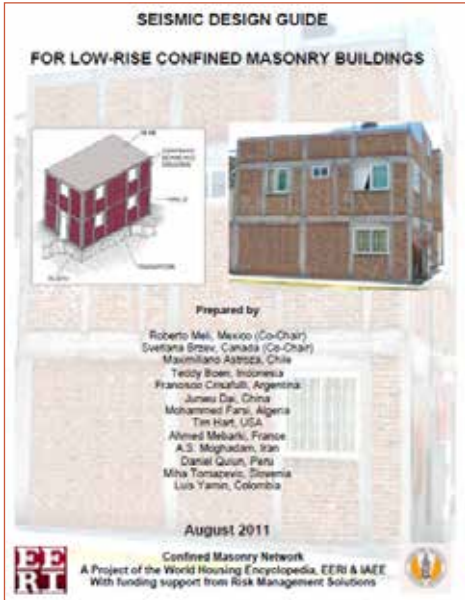

Figure 5.2.10 The tutorial on stone masonry construction

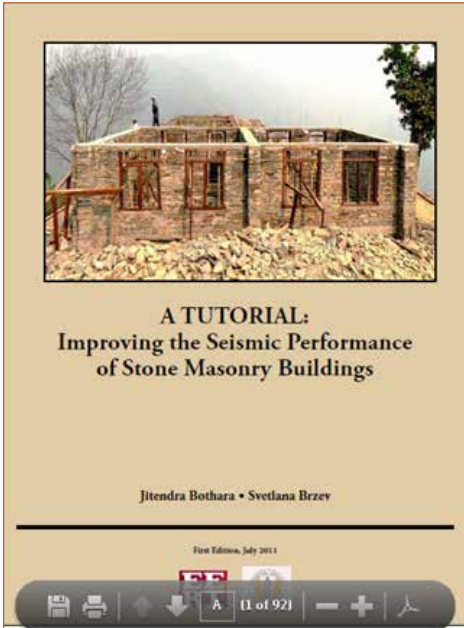
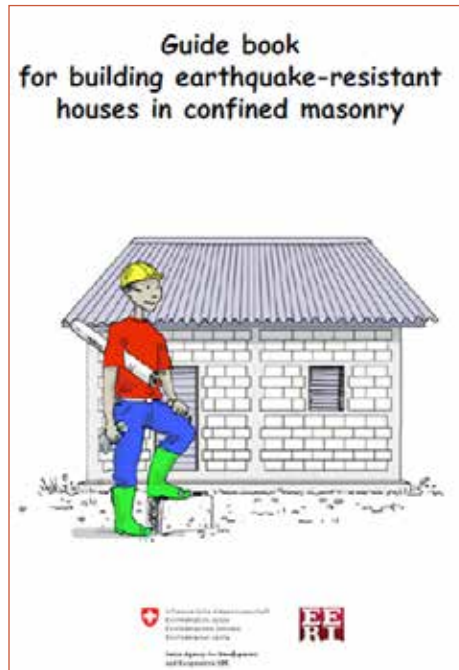

Figure 5.2.11 The latest tutorial on building with confined masonry



## 5.3 Formal Guidelines on Masonry

### 5.3.1 Overview

Many buildings of non-engineered construction are categorized as masonry structure, such as brick masonry and stone masonry. Masonry structures are one of most common structure types worldwide. Before modern structures, such as reinforced concrete and steel structures were invented, many buildings were constructed of masonry, including large-scale monumental buildings, such as palaces, castles, churches and offices. During those eras, leading architects, engineers and scientists worked on masonry structures and accumulated technical knowledge. In this context, many countries have official technical guidelines. They are useful resource

of technical knowledge in creating technical guidelines for non-engineered construction by low income people, even though limited parts of the guidelines are actually useful to them. In this section, some typical official technical guidelines are introduced.

### 5.3.2 International Building Code (IBC)

IBC is a model building code, developed by the International Code Council (ICC). It has been adopted by most states in the US. IBC consists of 35 chapters, with Chapter 21 addressing masonry design and construction.

## Overview of Chapter 21

Chapter 21 provides comprehensive and practical requirements for masonry construction, in the sub-sections shown below, based on the latest state of technical knowledge.

Section 2101: General

Section 2102: Definitions and notations

Section 2103: Masonry construction materials

Section 2104: Construction

Section 2105: Quality assurance

Section 2106: Seismic design

Section 2107: Allowable stress design

Section 2108: Strength design of masonry

Section 2109: Empirical design of masonry

The design methods listed in the provisions can be categorized into two general design approaches for masonry. The first approach, the engineered design, encompasses allowable stress, pre-stressed masonry and strength design. The second approach, prescriptive design, includes the empirical design method. Prescriptive design does not require engineering analysis under some certain limited conditions, which are described in detail later.

### Materials

Section 2103 refers to masonry materials, covered by the Code, namely concrete, clay, shale, AAC (autoclaved aerated concrete) and stone. It also addresses test procedures and criteria related to ASTM (American Society for Testing and Materials) international standards.

### Quality Assurance

Section 2105 addresses the inspection and testing requirements of Chapter 17, which references the quality assurance provisions in the MSJC (Masonry Standards Joint Committee) Code [5.13] and specifications. It emphasizes verification of compressive strength for masonry and standard strength is shown for compressive strength of units and mortar for each of materials.

### Seismic design

Section 2106 requires the use of the MSJC Code for specific seismic-design criteria. Requirements established for various seismic-risk categories are cumulative, from lower to higher categories. These prescriptive and design-oriented provisions have been established to improve the performance of masonry structures during seismic events by providing additional structural strength, ductility and stability against the dynamic effects of earthquake ground motion.

More information on seismic design is contained in the commentaries of ASCE 7-10 [5.14] and the 2009 National Earthquake Hazards Reduction Program (NEHRP) and Recommended Provisions for Seismic Regulations for New Buildings and Other Structures (FEMA P-750) [5.15].

### Allowable stress design and strength design

Two types of design are stipulated in the code, in Section 2107: allowable stress design, and strength design, in Section 2108. Both of them require that general provisions of each design in the code are followed and that MSJC code is referred to.



### Empirical design of masonry, with a focus on adobe construction

Section 2109 has empirical provisions, which are design rules that have evolved through experience rather than through engineering analysis. This method is based on several premises of design conditions and limits of application. A check list (Appendix A of the MSJC Code) is provided for the issue.

Adobe construction is covered in this section. Requirements for adobe construction are a combination of empirical provisions and rudimentary engineering. Since there are no ASTM standards for adobe materials, test methods have been included in the code. Major items in the section are as follows:

#### a) Classification of adobe

Unstabilized adobe: It does not contain stabilizers (cement, lime or others) and is generally not durable.

b) Stabilized adobe: It is manufactured with stabilizers to increase its durability and decrease its water absorption.

#### Compressive strength

Average compressive strength, based on five specimens tested, must be at least 2.07 MPa and no individual unit is permitted to have less than 1.72 MPa.

#### c) Number of stories

Adobe construction shall be limited to buildings not exceeding one story, except when designed by a registered design professional, in which case two-story construction is allowed.

#### d) Wall thickness

The minimum thickness of exterior walls of one-story buildings shall be 254 mm. The walls shall be laterally supported at

intervals not exceeding 7315 mm. The minimum thickness of interior load-bearing walls shall be 203 mm. In no case shall the unsupported height of any wall constructed of adobe units exceed 10 times the thickness of such a wall.

#### e) Wooden tie-beams

Wooden tie beams shall have a minimum depth of 152 mm and a minimum width of 254 mm.

Wooden tie beams is constructed above adobe masonry walls to distribute loads by floors and roofs.

## 5.3.3 Euro Code

### Overview of the EURO CODE on Structures

The Structural Eurocode program is comprised of the following standards:

EN 1990, Eurocode: Basis of structural design

EN 1991, Eurocode 1: Actions on structures

EN 1992, Eurocode 2: Design of concrete structures

EN 1993, Eurocode 3: Design of steel structures

EN 1994, Eurocode 4: Design of composite steel- and concrete structures

EN 1995, Eurocode 5: Design of timber structures

EN 1996, Eurocode 6: Design of masonry structures

EN 1997, Eurocode 7: Geotechnical design

EN 1998, Eurocode 8: Design of structures for earthquake resistance

EN 1999, Eurocode 9: Design of aluminum structures

The Eurocode standards provide common structural-design rules for everyday use of the design of whole structures and component products of both a traditional- and of an innovative nature. Unusual forms of construction or design conditions are not specifically covered and additional expert-consideration will be required by the designer in such cases.

Each part of the Eurocode has a National Annex (NA), which provides Nationally Determined Parameters (NDPs) to be used in the application of the Eurocode in a particular country. Typically, the National Annex will state values and classes applicable to that country and only a symbol is given in the Eurocode. This method makes it possible for different countries to use the Eurocode without any inconsistencies.

### Overview of Eurocode 6: Design of masonry structures

A) Scope of Eurocode 6 is as follows:

- a) Eurocode 6 applies to the design of buildings and civil engineering works, or parts thereof, in unreinforced, reinforced, prestressed and confined masonry.
- b) Eurocode 6 deals only with requirements for resistance, serviceability and durability of structures. Other requirements, for example, concerning thermal or sound insulation, are not considered.
- c) Execution is covered to the extent that is necessary to indicate the quality of the construction materials and products that should be used and the standard of

workmanship on site that is required in order to comply with the assumptions made in the design rules.

- d) Eurocode 6 does not cover any of the special requirements of seismic design. Provisions related to such requirements are given in Eurocode 8, which complements Eurocode 6, and is consistent with it .
- e) Numerical values of actions on buildings and civil engineering works to be taken into account in the design are not given in Eurocode 6; they are provided in Eurocode 1.

### B) Parts of Eurocode 6 and outline of major parts

Eurocode 6 is comprised of the following parts:

- Part 1-1: General rules for reinforced and unreinforced masonry structure
- Part 1-2: Structural fire-design
- Part 2: Design considerations, selection of materials and execution of masonry work
- Part 3: Simplified calculation methods for unreinforced masonry structures

#### ■ Part 1-2: Structural fire-design

This part deals with the design of masonry structures for the accidental situation of fire exposure and identifies differences from, or supplements to, normal temperature design. Only passive methods of fire protection are considered; active methods are not covered. It addresses the need to avoid premature collapse of the structure and to limit the spread of fire.

#### ■ Part 2: Design consideration, selection of materials and execution of masonry work

This part provides the basic rules for the selection and execution of masonry

work to ensure that it complies with the design assumptions of the other parts of Eurocode 6. It includes guidance for factors that affect performance and durability, storage and the use of materials, site erection and protection, and an assessment of the appearance of masonry.

- Part 3: Simplified calculation methods for unreinforced masonry structures
- This part contains simplified calculation methods for unreinforced masonry structures. These methods are based on the principles stated in Part 1 and should not be confused with any simple rules developed on the basis of experience. In general, these methods are more conservative than designs based on Part 1.

### Overview of Eurocode 8: Design of structures for earthquake resistance

The scope of Eurocode 8 is to apply the design and construction of buildings and civil engineering works in seismic regions for all types of structures, including those of masonry. Its purpose is to ensure that in the event of earthquakes:

- human lives are protected
- damage is limited
- structures important for civil protection remain operational.

Section 9 of Eurocode 8 is specific rules for masonry buildings. This section applies to the design of buildings of unreinforced, confined and reinforced masonry in seismic regions and are additional rules of Eurocode 6. (Eurocode 8 does not consider out-of-plane deformation of the walls, while in the framework of Eurocode 6 the effects of

in-plane- and out-of-plane action are considered simultaneously.)

## 5.3.4 Japanese Code for Masonry Structures

### Overview

The Japanese Building Standard Law and related orders have provisions for masonry structures. The Cabinet Order, which is under the Law, defines most of the basic, technical standards. Chapter 3 of the Cabinet Order stipulates general matters of “Design Strength”, basic principles, such as structural calculations, various loads, strength of materials and requirements for every structural type. In the Cabinet Order there are two sections for requirements for masonry structures, Section 4 for Non-reinforced Masonry Structures, and Section 4-2 for Reinforced Hollow Concrete Block Structures. These two sections are “specification-type codes”, which are applied to buildings of height of 13m or less, or eave height of 9m or less. For higher masonry buildings, which are rare in Japan, verification of structural safety by structural calculation is required. The Cabinet Order stipulates basic issues and details are defined in a publication by the Architectural Institute of Japan (AIJ), for practice, which is the largest and most prevalent academic organization in Japan for architecture and engineering for buildings. In the following sub sections, an outline of the provisions of the Cabinet Order and some examples of key issues in the AIJ publication are described.

### Unreinforced masonry structures

#### a) Scope

Brick masonry, stone masonry, masonry

of concrete block or other materials (except reinforced hollow- concrete- block masonry), and composite masonry structures with wood or other materials

#### b) Joint mortar

Mixture ratio by volume:

- cement:sand = 1:3 or equivalent strength, or

#### d) Thickness of walls (cm)

Numbers of stories	Length of walls: 5m or less	Length of walls: longer than 5m
two or more	30 cm	40 cm
one	20cm	30cm

In the case that 1/15 of story height is greater than in the above table, the thickness shall be 1/15 of story height.

#### e) Collar beams

On the top of the masonry walls of each story, continuous cast-in-place RC or steel collar beams shall be provided.

#### f) Openings

Length, height and position of opening shall follow designated values for each.

### Reinforced concrete hollow block structures

#### a) Scope

Reinforced concrete hollow-block masonry and composite-masonry structure with RC or other materials

#### b) Bearing walls

Areas surrounded by reinforced concrete hollow-block-masonry bearing walls shall be 60 m<sup>2</sup> or less.

Total length of reinforced concrete hollow-block-masonry bearing walls in each story shall be 0.15m, multiplied by the total floor area.

- cement:lime:sand=1:2:5 or equivalent strength

#### c) Length of masonry walls

Length of walls (distance between connections with adjacent walls or buttresses) shall be 10m or less

Thickness of bearing walls shall be 15cm or more. In the case that 1/50 of the length of the wall (distance between connections with adjacent walls) is larger than 15cm, thickness shall be 1/50 of the length of the wall. Rebar shall be installed in bearing walls. Diameter of rebar at corners or ends shall be 12mm or larger. Rebar of diameter 9mm or larger shall be installed in walls every 80cm in both horizontal and vertical directions. Rebar shall be anchored to adjacent RC members of foundation or collar beams by length of 40 times of diameter.

Vertical rebar shall be welded when connected. For horizontal rebar it is allowed to employ an overlapping splice with lapping of 25 times of diameter.

#### c) Collar beams

On the top of the masonry walls of each story, continuous cast-in-place RC collar beams shall be provided.

### Commentary on AIJ Standard for Structural Design of Unreinforced Masonry Structures by AIJ

Architectural Institute of Japan (AIJ)

publishes various technical guidelines based on contribution of its members of researchers and engineers. It publishes a standard on masonry structures covering several types including non-reinforced masonry and reinforced concrete hollow block masonry. This subsection introduces outline of standard on unreinforced masonry structure.

The standard and its commentary by AIJ provide practical and detail provision and explanation in systematic manner. It has 14 articles as follows with many illustrations for better understanding.

Article 1: Scope of application

Article 2: Typology and materials

Article 3: Maximum height of masonry structures

Article 4: Arrangement of walls

Article 5: Thickness of walls

Article 6: Openings of walls

Article 7: Reinforcement for upper part of openings

Article 8: Carving of masonry walls

Article 9: Collar beams

Article 10: Slabs and roofs

Article 11: Supports for walls of composite structures

Article 12: Foundation

Article 13: Masonry garden walls and fences

Article 14: Construction work

Figure 5.3.1 Function of collar beams of one-story masonry building

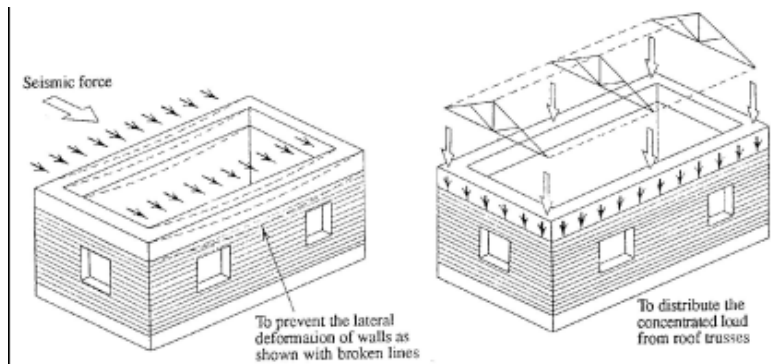
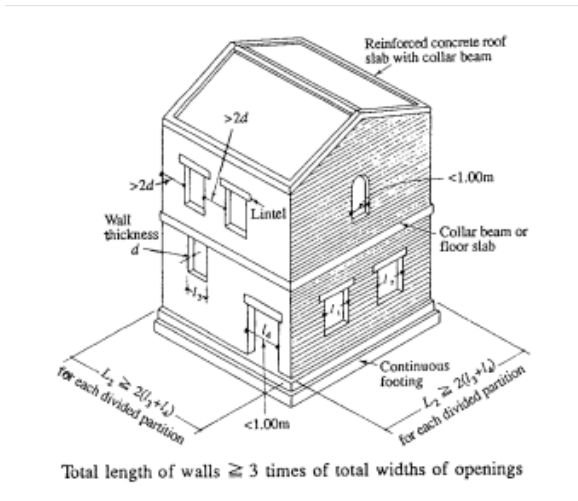

Figure 5.3.2 Limits on openings in masonry walls



## 5.4 Official Guidelines for Non-Engineered Construction

### 5.4.1 Introduction

The objective construction of this publication can be defined as “buildings that are spontaneously and informally constructed in the traditional manner, without intervention by qualified architects or engineers in their design”. Following this definition, most technical guidelines are informal, such as those shown in 5.2. However, there are several official technical guidelines. This section shows examples of those in developing countries. The experience of Japan regarding conventional wooden houses is also explained.

### 5.4.2 Overview of Formal Guidelines on Non-Engineered Construction in Developing Countries

#### Nepal

##### Outline of National Building Codes (NBC)

After the 1988 earthquake (M 6.7), the Department of Urban Development and Building Construction (DUDBC) of the Ministry of Physical Planning and Works (MPPW, now reorganized as the Ministry of Urban Development (MoUD)), prepared a draft of a series of National Building Codes (NBC), in 1993, with the assistance

of the United Nations Development Program (UNDP) and the UN Centre for Human Settlement (HABITAT). The Ministry promulgated them in 1994 and issued a notice in the Gazette in 2006 that NBC should be implemented by all municipalities and by some Village Development Committees (VDCs) in Nepal. In 2002, prior to the formal due date for implementation, Lalitpur Sub-Metropolitan City (LSMC) implemented NBC, becoming the first municipality in Nepal to do so. In 2004, Kathmandu Metropolitan City implemented NBC, then Dharan Municipality in 2006, Illam in 2008, Hetauda in 2010, Birgunj in 2011, and Byas municipality in 2011. Five more municipalities did so in 2013, and in 2014, 9 municipalities adopted NBC, resulting in 26 municipalities in total (out of 191 total municipalities in Nepal) that now have NBC in effect in Nepal (as of Dec. 2014).

### Categories of NBC

Nepal National Building Code (NBC) is classified into 4 types, based on targeted buildings, as shown in the Table 5.4.1.

Type 3 (Mandatory Rules of Thumb; MRT) and type 4 (Guideline) are provided for “Non (Pre)-engineered” structures.

It is very remarkable that the official guidelines for non-engineered structures were developed along with ones for engineered structures in Nepal. In most developing countries, official technical guidelines are introduced by direct import or through a slight adaption to each country’s own conditions because of insufficient information, knowledge and experts. Creation of non-engineered structures requires detailed information on housing, such as materials, construction methods, and analysis of the vulnerability of each type.

Table 5.4.1 Category of buildings and relevant Nepal National Building Code (NBC)

Type of codes	National Building Codes	Targeted buildings and application
1 International State-of-the-Art	NBC 000	Large buildings To comply with existing international state-of-the art building codes
2 Engineering codes	NBC 101- 114, 206-208	Building area: 1,000 sq. ft. or more, or number of stories: 3 or more, or span: 4.5m or longer, or irregular in shape To be designed and supervised by engineers (with a university degree in engineering)
3 Mandatory Rules of Thumb	NBC 201, 202, 205	Buildings smaller than those in category 2 To be designed and supervised by technicians where engineers are not available
4 Guidelines for Remote Rural Buildings	NBC 203, 204	Low Strength Masonry or Earthen Buildings To be constructed by local masons

Table 5.4.2 List of Mandatory Rules of Thumb and Guidelines

Code Number	Type of code	Code Title
NBC 201: 1994	Mandatory Rules of Thumb	Reinforced Concrete Buildings with Masonry Infill
NBC 202: 1994	Mandatory Rules of Thumb	Load Bearing Masonry
NBC 203: 1994	Guidelines	Earthquake Resistant Building Construction: Low Strength Masonry
NBC 204: 1994	Guidelines	Earthquake Resistant Building Construction: Earthen Building (EB)
NBC 205: 1994	Mandatory Rules of Thumb	Reinforce Concrete Buildings Without Masonry Infill

## Peru

Peru has been hit by large scale earthquakes and suffered heavy damages again and again. The most vulnerable type of house is the adobe house. A number of researchers have actively conducted research and development on adobe houses. Based on their achievements of research a national official technical guideline, Norma Tecnica E.080 Adobe, was created in 1990. It has a seismic-hazard map and provisions on reinforcing materials (several materials are allowed) and their applications, required length and width of walls, and so on. The construction method employed in projects of examples no. 3, no. 5 and no. 8 in Section 5.1 employed construction methods following this guideline.

## Indonesia

Indonesia is one of the countries most frequently hit by earthquakes. They created a national standard on seismic design of buildings, SNI 1726-2012: Manual for Seismic Resistance Designing for Buildings and Other Structures (revised in 2012), in 1991. This referred to US codes, such as IBC, ASCE/SEI, FEMA and NEHRP and was applicable

to engineered structures. In 2006, the Central Java Earthquake hit Indonesia and caused huge damage, with casualties of more than 5,000. A huge number of small houses, most of them non-engineered, were destroyed. In reconstruction, a simple technical guideline called "Key Requirement" was created, which must be applied to one-story confined masonry houses for reconstruction from the disaster.

The central government of Indonesia appreciated this approach for improving the quality of non-engineered houses. As there were no effective technical guidelines for non-engineered houses, nor was there a building-regulation system/institution effective for non-engineered housing at that time. They started an initiative to diffuse this approach nationwide with technical cooperation from Japan. In February 2016 a decree was issued by the Minister of Public Works and National Housing including technical guidelines for non-engineered housing, based on the "Key Requirement" and 9 prototypes which meet the provision of the guideline. The decree is user-friendly, with many illustrations in the guideline (Figure 5.4.1) and prototypes.



Figure 5.4.1 An illustration on the details of connection of beam and column in the decree on building permits by the Minister of Public Works and National Housing



Gambar 48. Hubungan Anatar Kolom dengan Balok Keliling/ Ring

Source: PERATURAN MENTERI PEKERJAAN UMUM DAN PERUMAHAN RAKYAT (REPUBLIK INDONESIA) NOMOR 05/PRT/M/2016, Republic of Indonesia

### El Salvador

El Salvador had several technical guidelines relating to seismic design that were developed during 1997 to 2004. They require structural calculations and only engineers who learn in engineering in universities can conduct these calculations. Under these circumstances, the government of El Salvador requested that Japan provide technical cooperation. In the project, research- and development activities were actively conducted (Figure

5.4.2) and drafts of 4 technical guidelines for various types of structures were made. These structures were considered to be, at the time, (or could be in the future) feasible and popular among low income people, namely seismic adobe, confined masonry with soil cement block, concrete block and block panel. In 2014, all 4 of the guidelines went through official procedures and became national formal technical-guidelines of El Salvador.

Figure 5.4.2 Very simple and effective experiment with full scale model using tilting table



### 5.4.3 Experience of Japan with Formal Guidelines for Non-Engineered Construction

#### Overview

The current building-control legal framework in Japan was established in 1950 upon enactment of the Building Standard Law (BSL). Before the BSL, building regulation was implemented by the Urban Building Law, enacted in 1919. Under the Urban Building Law building regulation (two types of procedures, building permits and reports/notifications) was limited to large scale buildings in large cities, and small houses were exempted from the regulation. Upon the legislation of the BSL, applications for building permits for housing for were subjected to building regulatory procedures. Most of these houses were constructed of timber, by local carpenters, in a conventional manner. Those carpenters were skilled workers, who received on-the-job training from their senior colleagues but had little engineering knowledge.

In spite of this situation, the method of building these wooden houses was to follow essentially the same procedures under the new legal framework, as for buildings such as reinforced concrete buildings, which were designed and whose construction was supervised by engineers.

Implementation of building regulations under the BSL regarding small

conventional wooden houses has been the source of various kinds of problems and friction, and has required much effort in various sectors. These sectors have had to cope with issues of feasible and practical technical guidelines, capacity development of carpenters, innovation of user friendly technologies, and development of effective parts/components. Furthermore, under national inter-sectoral framework for critical national policies at the moment in Japan, such as the promotion of mass supply of quality houses and modernization of small-scale businesses in all the sectors, enhancement of quality of these houses were pursued.

The Kobe Earthquake, in 1995, proved that these long-term efforts had achieved the objective quite successfully. A field survey revealed that most of the heavily damaged wooden houses were of sub-standard construction. Their construction followed standards at the time of construction and houses following current standard (constructed after 1981, as an important revision of the structural standard was made in 1981) suffered little damage. (See Figure 5.4.3. This fact recognized the importance of the retrofitting of old sub-standard houses. New legislation to promote retrofitting was passed in 1995. The survey on damaged houses from the Great East Japan Earthquake Disaster 2011 affirmed the fact that houses on current standards are resilient against earthquakes.

Figure 5.4.3 Many wooden houses collapsed in the Kobe Earthquake 1995 (left), but new houses, following the revised code in 1981, suffered little damage, even in otherwise heavily damaged areas (right)



Figure 5.4.4 Break down of collapsed buildings by Kobe Earthquake in years of construction

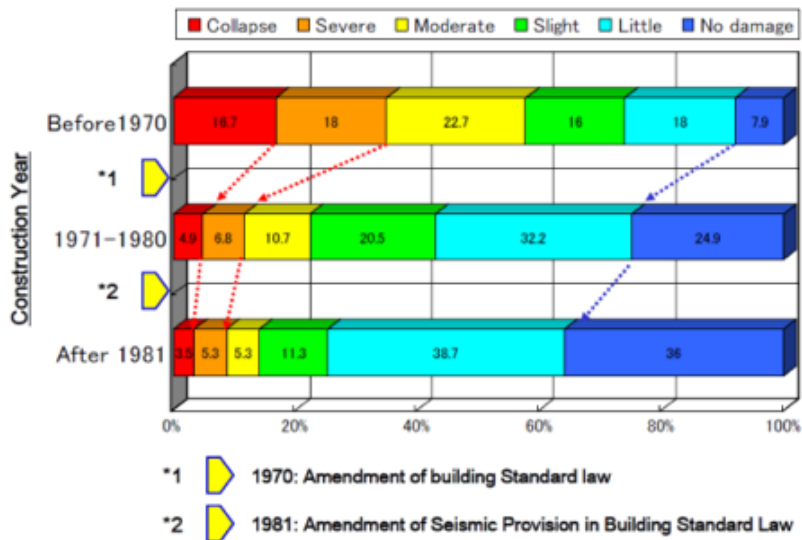

(Source: Interim Report of Survey on Damage to Buildings, Committee for Survey on Buildings, August 1995)

### Legal framework

A technical standard for wooden houses was stipulated by Cabinet Order, based on the BSL, just as for other types of structures, such as reinforced concrete and steel structures. The seismic design code for wooden houses was created based on the same intensity of earthquake as for other structures, even though the code is a descriptive one and structural

calculation based on earthquake loads is not mandatory, except for buildings with three stories or more. The BSL requires all builders of buildings to follow building regulation procedures, such as securing building permits and receiving completion inspections, except for temporary structures, buildings constructed in remote areas, and some others. Application for building permits requires

accompanying drawings and other design documents, which is one of the most serious problems, as it was commonplace for conventional wooden houses to be built based on a simple layout, and most carpenters did not know how to make drawings when the law was enacted.

Another critical issue is the legal qualification scheme. The Kenchiku-shi Law (Law for Architectural Engineers) was enacted in 1950, the same year as the BSL. This law defines the qualification of architectural engineers as 1<sup>st</sup>, or 2<sup>nd</sup> class. The qualified architectural engineers are allowed to design buildings of structural type and scale based on their class of qualification. This qualification also caused critical problems for carpenters as the qualification examination was a written examination on 1) knowledge of architectural planning and design, structural engineering, construction engineering and building regulations and 2) drafting skills. Most of these skills could be obtained at universities or technical schools, but which were difficult for ordinary carpenters to obtain.

### Strategies to enhance safety in various sectors

#### a) Descriptive type codes

Technical codes for conventional wooden houses were of a descriptive type for ordinary one- or two-story houses, which are far simpler, compared with other structures and easy for carpenters with little technical knowledge. The codes were revised again and again. In order to obtain technical background of the revision various experiments of strength test, cyclic loading test, and shaking table tests for materials, members and full-scale models have been conducted.

#### b) New category of qualification for wooden houses

The Kenchiku-shi Law was amended in 1984 to add a new category of architectural engineers, "Architectural Engineer for Wooden Building", who were specialists in the design of wooden houses. The qualification examination was designed to be more suitable for carpenters in practice in order to ease the problems caused by the former qualification of 1<sup>st</sup> and 2<sup>nd</sup> Grade Architectural Engineers.

#### c) Research and development

Research and development for stronger, safer and more durable houses have been actively conducted by the lead of governments. One of the remarkable achievements is the improvement of the connection of members. Traditionally, most wooden-house construction in Japan had a structural system of a column-and-beam frame. The connections of structural members were cut and notched on site for immediate assembly. Use of metal materials was limited to simple nails. This became a critical issue because failure at connections proved to be one of the most common causes of serious damage by earthquakes and a decrease in the number of skilled carpenters necessitated an increase in labor costs to cut and notch timber on site. To cope with this situation, technologies for pre-cut timber and metal connection was innovated.

#### *Pre-cut timber (See Fig.5.4.5)*

Pre-cut timber is cut and notched by numerical control cutting machines in factories, instead of skilled carpenters cutting ordinary lumber on site. A complete set of cut-and-notched timber for a whole house is prepared and

delivered upon an order from a carpenter with usual drawings (no need for specific drawings). Nowadays, most conventional wooden housing employs this technology.

*Metal connectors (See Fig.5.4.6)*

Metal connectors make connection of timbers far stronger than the former

standard method of traditional connection with notches and nails. Various types of connectors are designed for each of type of connection (column to beam, brace to plinth, etc.). A quality assurance scheme was established and managed for safe construction.

Figure 5.4.5 An example of pre-cut timber cut by numerical control cutting machines



Figure 5.4.6 Example of metal connectors. Brace to plinth/column type (left), column to beam type (middle) Certificate mark of quality assurance scheme (right)



# CHAPTER 6

---

## TOWARDS RESILIENT NON-ENGINEERED CONSTRUCTION

---

### 6.1 Introduction

Chapter 1 shows the total perspective of issues on safer non-engineered construction. The following chapters explain all of the aspects/phases that are essential for the creation of resilient non-engineered construction.

Chapter 2 describes what earthquake risk is and how it can be assessed. It analyzes how people recognize such risks as well.

Chapter 3 shows the vulnerability of non-engineered construction, and its technical and social background, including on-site construction practice.

Chapter 4 provides an overview of the technical approach and introduces examples of basic experimental studies, which are technical basis for earthquake resilient structures.

Chapter 5 deals with how technical information should be delivered and applied by house owners and construction workers.

Chapter 6 discusses the remaining issue of how to realize disaster mitigation. One

very important characteristic of the non-engineered problem is that most users are low income people. Even though they understand risk, learn seismic design knowledge, and have a desire to live in safer houses, there still exists difficulties for them, thus some kinds of support are necessary, as stated in Section 1.1. (E: Support in Figure 6.1.1) Also there are remaining difficulties for other stakeholders. As stakeholders are made up of local and central governments, professional consultants, engineers, social workers, donors, NGOs and international organizations, platforms are necessary to share information and cooperate with each other. (F: International Platform in Figure 6.1.1) Establishing an environment that is suitable for donors to sustain development with few resources is another critical issue. (G: Environment for Sustainable Development and a Movement in Figure 6.1.1) Strategies for each of all the items are needed to establish a complete roadmap to safer non-engineered construction.

**Figure 6.1.1 The Relationship between Relevant Items for Safer Non-engineered Houses**

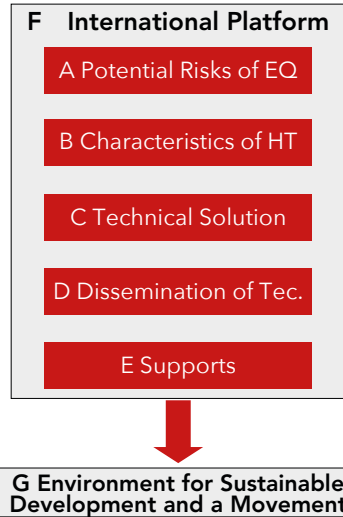

## 6.2 Necessity of Support and a Collaborative Platform

Since most dwellers of non-engineered houses are low income people, most of the difficulties associated with this issue are analyzed as being in common with “poverty reduction”, which is the most important target for international communities. They have fewer opportunities in every aspect, such as jobs/income, basic education, access to safe drinking water, nutrition, living environment and safety against disasters. Therefore, some kind of support or encouragement is necessary, both in financially and socially. This fact implies that an engineering approach alone could not solve these problems and collaboration with other sectors, such as economists, sociologists and cultural anthropologists is required.

Huge support provided for reconstruction from disasters is stopped when the “reconstruction phase” is finished. When

support is withdrawn, activities for safer construction also stop in most cases. In the case of Peru, dissemination spread beyond the original target group in one of the project sites with the support of NGOs (1.1.5) E), but no such movement is observed in other regions. In other words, adoption of technologies or actions for safer housing by low-income people needs some kind of support. Because of the limit of both financial and human resources, input for support should be minimized. At the same time, support should be continuous for a certain period because it takes time to reconstruct or retrofit vulnerable houses, which exist in large numbers in a community.

From this point of view, the principle of “mainstreaming of disaster risk reduction” is recommendable, which means that the viewpoint of disaster management should be integrated

into all of the development activities/projects. The non-engineered issue should be addressed as a part of the improvement of living conditions or safe and healthy living. This could be parts of comprehensive-type projects for poverty reduction or community development, as those types of projects have more in common with longer term projects than projects in the disaster management sector or reconstruction from disasters.

This approach has proven to be feasible, considering the experience of Japan with conventional wooden houses, which could be classified as non-engineered, as they are constructed by carpenters, with little intervention of engineers. (Section 5.4.3) In Japan, in order to improve the quality of houses, including safety against earthquakes, measures were taken not only by the disaster management sector, but also from various sectors aiming at important national goals, such as a

mass supply of houses against a housing shortage, reconstruction of the business sector to focus on small-scale industries and the lumber industry, vocational training for workers for opportunity for higher income, and so on, all of which were quite big issues for Japan in recovering from the devastating damage caused by bombing during World War II.

Initiatives and activities to reduce disasters in non-engineered houses require various stakeholders, including local- and central governments, professional consultants, engineers, and social workers, donors, NGOs and international organizations. The number of stakeholders and the complexity of their activities require a platform for the exchange of their information and the coordination of their activities to ensure effective implementation in every region of every country.

### 6.3 Environment for Sustainable Development

In most cases, impacts from initiatives or projects on non-engineered houses have not succeeded in spreading beyond the scope of the initiatives. The total number of non-engineered houses is huge and resources of donors are limited. Therefore, an environment for sustainable development and a movement for safer houses is needed in which each community is supported once for a certain period of time, from outside supported by donors, after which the community is expected to continue the movement with less financial and social support.

Construction of houses is a large investment and could activate local

economies as they use local materials and provide job opportunities in the community or surrounding area. This effect brings more income to residents in the community and will lead to encourage the next group of people to invest in safer houses. This type of investment cycle could create an environment for sustainable development.

Some stakeholders, including the housing supply sector, could be key players in following ways. Manufacturers of building materials, such as cement: They make profit when houses are constructed and the potential capacity to keep some of it to contribute the communities. One



multinational manufacturer supported an international organization in the dissemination of technology with their funds and expertise.

Institutes for skill-training: Skill-training related to the construction sector is common in engineered construction,

where certificate of completion brings more job opportunities and income.

This approach has the possibility of being introduced into non-engineered construction with some modifications, such as cheaper tuition fees. There finds a donor which finds a good possibility in this approach and to try to apply this.

## 6.4 Steps for Safer Non-Engineered Houses

### 6.4.1 Possible Approaches

#### Start at a good entry point

As shown in Figure 6.1.1, there are several aspects of the non-engineered issue. One of recommendable ways to realize risk reduction is to start at good entry point, which should be selected based on the conditions of each country. If a county has potential capable researchers or engineers, the capacity development of those people would be a good entry point. They could be leaders in of the next steps. Reconstruction from earthquake disasters is also a good entry point, as many people remember the disaster well and have high motivation to secure safety. Recognition of future earthquake risks caused by earthquakes in neighboring countries or a campaign of international organization creates a similar situation. For this approach, it is essential to draw a road map and expand the scope of activities in the next steps on it.

#### Strategic approach based on total perspective

This is an opposite type of approach to “Start at a good entry point”. Based on a complete survey on all the relevant items, the total perspective on the issues of a country should be prepared in order to

identify weak points. Then several items/parts should be selected, which would maximize impacts within the limited resources of a country.

#### Multiplication of a trigger activity

Where a small but high potential activity is going on, it will be another effective approach to focus on and multiply in neighboring areas. Several activities could be a trigger, such as trials by leading local governments, case studies by researchers, and activities by NGOs.

#### Expansion of scope of comprehensive projects

Where successful comprehensive types of projects are going on, such as community development, a possible approach is to add a component concerning safer houses. If the project has enough financial resources, construction of model houses is a possibility, such as the case of Peru (Annex A2.1). If not, simply disseminating technology could be more effective because activities on a basis of good governance of the community, which are established by the project, are far more effective than independent dissemination activities. The comprehensive projects also benefit from their scope of fields

being expanded. Some movements are already observed in several countries.

## 6.4.2 Topics to be Discussed

### Reduction of mortality

The first global target, in Chapter 2, “The expected outcome and goal” of the Sendai Framework for Disaster Risk Reduction is stated as “Substantially reduce global disaster mortality by 2030, aiming to lower the average global mortality rate per-100,000 in the decade of 2020–2030, compared with the period 2005–2015”. Earthquake disasters are characterized by high mortality compared with other disasters and most of them are caused by collapse of non-engineered houses. When policy is discussed in accordance to the Sendai Framework, a high priority should be given to the issue of non-engineered construction.

### Priority and balance between engineered- and non-engineered construction.

As mentioned in the previous sub-section, high priority should be given to non-engineered construction. However, the ‘non-engineered issue’ is far more difficult than that of the ‘engineered’. Under the condition that both engineered and non-engineered issues have difficulties, such as scarcity of qualified engineers, researchers or foremen, it might be a good strategy to work on the engineered issue first. It could be expected that some of the people involved in the activities would recognize the importance of the non-engineered issue and use some of their time and efforts for non-engineered issues. Those people would most likely be contributors for the issue in each of country.

### Two possible channels, informal and formal

Policies and institutions for engineered construction follow formal channels, such as for official building permits based on official technical guidelines, which follow legal procedures stipulated by law. Japan has an established legal framework of building administration that all the buildings and houses, including non-engineered, should follow official procedures and make huge efforts to ease friction caused by non-engineered construction. (Section 5.4.3). Several other countries mentioned in Section 5.4.2 use this channel. However, another, informal channel may be feasible and rational in countries where administration capacity is insufficient at the moment.

### Initiative specific to the non-engineered issue or mainstreaming in various projects

Initiative specific to the non-engineered issue, such as reconstruction following disasters could consume large amounts of resources and afford to take powerful measures such as subsidies and strong enforcement. But this type of initiative is implemented in limited situations, such as reconstruction following disasters. Also, duration of the initiatives is limited and further development after completion or sustainability often becomes a problem. Another way of mainstreaming in various projects has different features. The amount of resources is not usually huge, but there are far large number of projects around the world. Every possibility that is appropriate to conditions of each country should be pursued in either of these ways.

# APPENDIX

---

## PROJECT EXAMPLES

---

### A.0. Contents and Outline of Appendix

In Appendix, you will find some examples that employ different approaches for the challenges mentioned in the main report. A.1 will show training programs available for policy makers, researchers and practitioners from developing countries to start and/or scale-up the initiative to improve structural resilience and safety as part disaster-risk reduction efforts. The training covers non-engineering houses as one of the topics and it presents a wide range of risk-reduction practices through

the improvement of building- safety and resilience. A.2, concerns a project example implemented by development partners to strengthen non-engineered structures in Peru (A.2.1), Indonesia (A.2.2) and El Salvador (A.2.3). While not a significant number of academia have been studying non-engineered structures from an engineering and political science perspective, A.3 introduces networks among academia that was initiated by UNESCO and UNISDR.

### A.1. Capacity Building Programs

#### A.1.1 International Training on Earthquake Engineering

##### Background

The International Institute of Seismology and Earthquake Engineering (IISEE), Building Research Institute, Japan, and its training programs were established in the early 1960s through the collaboration of leading researchers from all over Japan, the Japanese Government, and

UN agencies, who aimed to cooperate in the fostering of seismic engineering specialists globally. Most notably, a group of Japanese scientists showed a strong commitment in this development, and since then people from these organizations have been leading the training program, in cooperation with the Japan International Cooperation Agency (JICA). As of September 2016, more than 1,750 participants have attended from 100 countries and regions.

Considering the major damage caused to buildings by earthquakes, and the required early warning system for tsunamis, IISEE's overall goal is to secure the safety of buildings and to provide the necessary information for tsunami evacuation.

### Available Courses

Today, IISEE provides four courses, as shown in table A.1.1. The regular course offers the degree of "Master of Disaster Management", in partnership with the National Graduate Institute for Policy Studies (GRIPS) in Japan.

Table A.1.1 Classification of IISEE International Training Courses

Training Course	Field	Capacity	Period	Ex-participants			
Regular	Seismology	Seismology	10	1 year Class-lectures i (8 months), Individual Study (2 months)	1960 - Present	538	1121
	Tsunami Disaster Mitigation	Tsunami Disaster Mitigation			2006 - Present	43	
	Earthquake Engineering	Earthquake Engineering	10		1960 - Present	540	
Seminar	China Seismic Building	Earthquake Engineering	20	2 months	2009 -2012	72	277
	Earthquake Engineering for Latin America	Earthquake Engineering	16	2 months (2 weeks in Latin America)	2014 - Present	30	
	Arbitrary	Seismology/ Earthquake Engineering	10 to 20	1 to 2 months	1980 -2000	175	
Global Seismological Observation	Seismology	10	2 months	1995 -Present		197	
Individual	Seismology/ Earthquake Engineering/ Tsunami	Several	upon request	1968 Present		108	

### The Seismology Course

Provides advanced knowledge and techniques in the fields of earthquake seismology and seismic hazards. Participants are from governmental organizations responsible for earthquake

monitoring and/or earthquake disaster mitigation in their respective countries. It provides theoretical classes on seismic hazard evaluation and earthquake disaster mitigation policies, in combination with practical training and study tours.

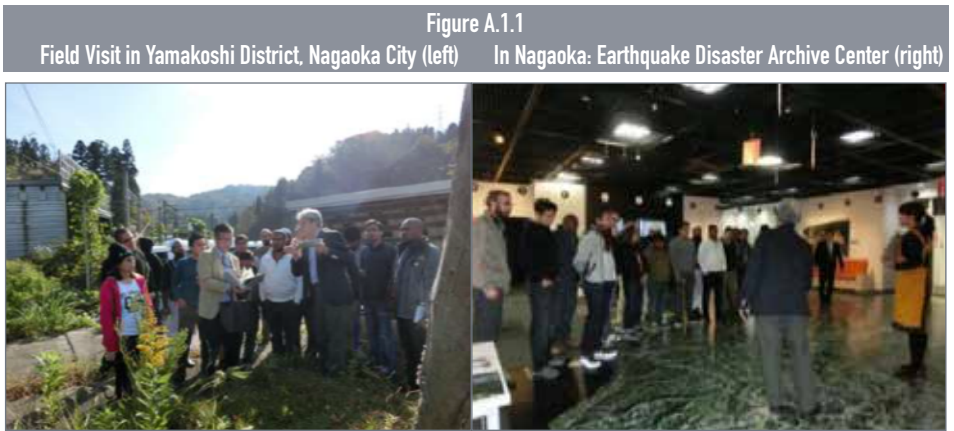

**Tsunami Disaster Management Course**  
This course began in 2006 after the devastating North Sumatra tsunami, in 2004. Lectures provide advanced

education, focusing on tsunami hazard evaluation, an early-warning mechanism, as well as overall tsunami risk mitigation planning.



**Earthquake Engineering Course**  
This is designed to contribute to the reduction of structural damage in developing countries, due to earthquakes, which also cause human suffering. Participants are mainly researchers and engineers from governments, research institutes and universities. The course will help participants develop a solid foundation of earthquake engineering,

such as structural analysis, structural dynamics, soil mechanics, etc., and then provides practical knowledge on earthquake resistant structures, seismic codes, seismic diagnosis, retrofitting techniques, etc. Furthermore, it provides knowledge based on the latest research on seismic isolation, response control techniques, and so on.

Figure A.1.3

Visiting construction site for retrofitting (left)

Group photo after lecture on shaking table test (right)



### Earthquake Engineering Course for Latin America

This is designed to foster leading structural engineers and governmental technical officers who are responsible for dissemination and/or education

of earthquake-resistant construction technology in their respective countries. The participants are expected to disseminate accumulated knowledge and to foster earthquake engineers back in their own countries.

Figure A.1.4

Concrete slump test during a technical visit in a concrete block factory in Japan (left)

Structural test in UCA, San Salvador (right)



### Global Seismological Observation Course

This course focuses on seismology and seismic observation to foster relevant professionals in developing countries, based on knowledge and technology

accumulated in Japan. Many of the former participants are now pursuing careers in research or teaching back in their respective countries.

Figure A.1.5 Observation of Matsushiro Seismological Observatory, Japan Meteorological Agency



### Individual Course

This is a tailor made course for those who already have high scholastic ability and professional experience. A participant pursues his/her own study individually with his/her supervisor at IISEE.

## A.1.2 JICA training on seismic risk reduction

### Course 1: Housing and living environment

JICA's training course on housing and living environment has a history of about 40 years. The course was redesigned to put more focus on disaster risk management, and since 2013 has been called "Improvement and Disaster Prevention of Housing and Living Environments". The training objective is to improve the capacity of policy makers at different levels of government entities that oversee the improvement of the disaster prevention aspect of housing- and living-environment policy. After 7 weeks of training, a group of 10-15 participants develop an action plan for their own countries, based on lectures, technical visits and group discussions. The latest course, conducted in 2015 covered:

1. Housing policy and its implementation by Japanese the government after World War II;
2. Relevant policies and government led projects for improvement of living environment (including energy efficiency);
3. Role of private sector in housing industry;
4. Project to renovate slum in Hiroshima, inhabited by A-bomb survivors, and in Osaka (private rental-house area for low income workers);
5. Post-disaster reconstruction projects from 1995 Kobe Earthquake and 2011 Great East Japan Earthquake and Tsunami;
6. Housing policies and disaster risk management in developing countries;
7. Case study of seismic risk assessment of urban areas in Ulaanbaatar, Mongolia;
8. Upgrade of living environment for low-income groups in developing countries, presented by the World Bank and UN Habitat;
9. Technical guidelines for strengthening and retrofitting non-engineered houses.

Figure A.1.6

Technical visit to historical district in Kyoto city where fire protection measures are implemented in ways so as to harmonize with historical cityscape (left)

Technical visit to experiment laboratory; participants experienced shaking motion on a shaking table (right)



## Course 2: Disaster management on buildings

This course has about a 40-year history. In 2012, the course was drastically redesigned to focus on disaster risk management, under a new course title: “Disaster Prevention of Buildings (Earthquakes, Tsunamis, Fires, Typhoons, etc.)”. The objective is to build capacity of government officials to better utilize building codes and regulatory systems to increase the number of disaster-proof buildings in developing countries. The participants are requested to pre-identify the priority issues for their own countries prior to joining the course. After they complete the training course they are expected to develop an action plan to solve those issues, based on the knowledge they

gained over the 7 weeks of training. The main topics covered in 2015 were:

1. Building codes and regulations in Japan;
2. Impacts and lessons learned from disasters, such as the Great Hanshin-Awaji Earthquake, 1995, and the Great East Japan Earthquake, 2011;
3. Structural safety and fire safety, including relevant building standards;
4. Safety against typhoons, including relevant building standards;
5. Resilient urban development;
6. Research and development, such as shaking table tests for building safety;
7. Disaster risk reduction for buildings in developing countries and technical cooperation by JICA (including non-engineered construction);



Technical visit to large shaking table in Miki city, Hyogo Prefecture (left)



Figure A.1.7

Lecture on safer non-engineered construction. Learning Indonesia's experience via video conference (right)



## A.2. Technical Assistance by Development Partners

### A.2.1 Peru: Dissemination of Technology for Seismically Resilient Non-engineered Houses

#### Background

To reduce damage from seismic activity, it is imperative to improve building technologies of vulnerable non-engineered houses. Also, technology dissemination is an important element to realize resilient non-engineered houses on the ground. This section will share one example employed by JICA in Peru; a training program on seismically resilient adobe (sun-dried brick) house construction, from 2005-2007. The program was conducted with the aim of disseminating the locally developed reinforcement technique of adobe construction using canes inside the walls. This method employs vertical- and horizontal reinforcement with canes inside the wall, with wooden ring beams placed on the tops of the adobe walls, and concrete foundations. The project

completed successfully as the participants understood the technique well and were motivated to employ it for their future houses.

In 2007, while the training program was being conducted, the Pisco Earthquake (magnitude 8, USGS) hit a wide area, including the project sites. The survey team found that all of the model houses constructed in 7 villages and towns under this project performed well against the seismic event. However, in spite of the success of improved structural performance through the program, the improved adobe-technique was not widely practiced. Only in one village where the NGOs actively conducted community development project, the technique was employed to houses which were constructed as a component of the project. This fact means that the success of a training program does not necessarily result in wide employment in practice. This experience provided two key lessons on effective information dissemination; modality and community empowerment.

## Training Summary

The training program was a combination of a classroom workshop and actual construction of model houses. The participants attended a workshop prior to each of the construction phases: a) manufacturing of adobe bricks; b) earthwork; c) foundation; d) adobe laying; e) carpentry; and f) finishing work. After each of the workshops, participants continued to construct model houses

under the technical guidance of experts from Research Institute for Sustainable Development for All (CIDAP), a Peruvian NGO working for the improvement of living environment of low income people, with support of municipalities that prepared housing sites and provided support for management. Eighty five participants were trained and seven model houses were constructed in two years.

Fig. A.2.1 A workshop before each phase of construction work



Fig. A.2.2 Construction of a model house by participants under technical guidance of experts



Fig. A.2.3 Adobe bricks with canes for vertical reinforcement

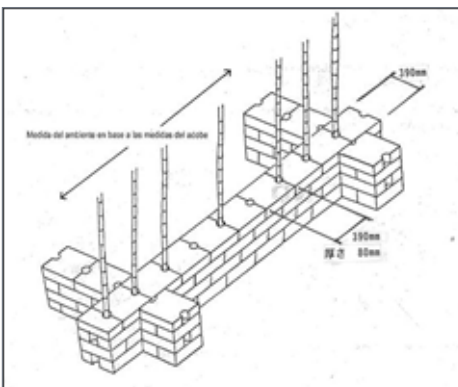

Fig. A.2.4 Installation of horizontal reinforcement from crushed cane



### Analysis on technology dissemination

The project analysed the impact of its dissemination approach through the training program. It observed that, in general, all the participants actively engaged, and precisely followed the guidance of the engineers. The follow-up interviews with participants indicated that 86 percent of the participants gained the confidence to build reinforced adobe houses by themselves. All the participants expressed satisfaction at acquiring knowledge of safe housing construction and indicated that they were willing to use this method for construction of their own houses in the future. However, the interview results after the 2007 Pisco Earthquake revealed that the impact of this approach is limited (not well-known in the community), although the

reinforcement technology performed well in the earthquake.

### Impact analysis after the 2007 Pisco Earthquake

#### Earthquake damages to houses

It was reported that more than 50,000 houses collapsed in the Pisco Earthquake. According to a detailed investigation conducted by JICA, adobe houses, in particular, were subject to extensive damage, accounting for 82.7% of the houses categorized as “collapsed” or “heavily damaged” in Ica State, the state with the most damage. The situation was the same in Lima State, which is adjacent to Ica State, where most of the construction sites of the case study project are located.

Figure A.2.5 Heavily damaged church (Adobe wall, vaulted roof made from quincha), Zuniga, Lima state



Figure A.2.6 Collapsed houses in central area of Zuniga, Lima state



#### Behaviour of model houses

One Model house constructed under this project, which was located 300 meters away from the central area of Zuniga, had no damage to any of the structural members (Figure A.2.9). On the other hand, a house just next to it, which wasn't part of the project, suffered severe damage (Figure A.2.10). Other model

houses also behaved well and had only minor damages. This demonstrated the improved performance of the strengthening technology employed for model houses, and the difference that adobe reinforcement technology can make, in comparison with conventional adobe construction without reinforcement.

Figure A.2.7 House A: A model house in Zuniga, no structural damage



Figure A.2.8 House B: A house without reinforcement, next to House A



Figure A.2.9 walls of an adobe house, House B



Figure A.2.10 maged Heavy cracks in House B



### Risk Perception of the affected community

An interview survey was conducted with people in Lunahuana, Canete Province, which was one of the 2005-project sites (near Zuniga). One person who resided next to the model house in Lunahuana and had observed the construction process acknowledged that there was a clear difference in the damages to conventional adobe houses and the reinforced adobe houses as a result of the earthquake. However, the overall results showed that about half of the interviewees in the same community were not aware of the objective of the model house project and the other half did not even recognize the existence of the model houses.

### Remaining challenges

#### Dissemination of technologies

As stated in the previous sub-section, it was realized after the earthquake that dissemination of technology is a big challenge. JICA's initial assumption was that model houses readily attract residents' attention and technology would be disseminated by word-of-mouth in such small villages and towns. However, the results of post-disaster interviews with residents indicated that the assumption was not consistent with reality. One reason could simply be a low level of public interest in activities in their own communities. The project was not well known even in such a small

community. Some Peruvians pointed out that many people are wary of talking to other people, which goes back times of civil war, when people were afraid to talk to neighbors and others in their communities. Another big reason is that dwellers of non-engineered houses in Peru have less awareness of earthquake risks, compared with people in countries such as Japan, where earthquakes are more frequent and the mass media actively reports them. This analysis underscores the essentialness of recognizing and understanding cultural- and social characteristics. . Particularly, the understanding of people's risk perception and an effective information dissemination mechanism in the community are the keys.

#### Continuity under local initiative

After the JICA training program was finished, an international NGO conducted projects for community development, including in Huangascar, one of the project sites of the JICA projects. Several adobe houses with the technology were constructed, however, similar movements didn't happen in four other JICA project sites, in spite of the fact that participants showed interest in applying the reinforcement technology to new houses. This implies that it is not enough to simply demonstrate the positive impact of the technology and to transfer knowledge of it, but also it's necessary to provide some kind of encouragement and proactive support. Two NGOs in Huangascar offered financial support for the reconstruction of houses and reminded people of the tragedy to persuade them to prepare for future earthquakes.

## Conclusion

This report on the dissemination of seismic technologies highlighted one of the important issues for safer non-engineered housing construction, based on the JICA project in Peru. The project achieved good results as a training program for those who participated, however, the challenge remains to achieve wide diffusion of the technology and to change people's behaviour regarding housing construction. The important lesson learned was the importance of consideration of cultural- and social circumstances, the implementation of an incentive mechanism and the necessity of proactive support to enable greater impacts.

### A.2.2. Indonesia: "Transforming "Non-Engineered" Housing to "Engineered": Experience in Central Java and Beyond

#### Background

A magnitude 6.3 earthquake hit the south part of Java island, Indonesia in May, 2006. The earthquake resulted in more than 5,000 losses of human lives, 154,000 houses were completely destroyed and 260,000 sustained structural damage. The majority of human losses was caused by the collapse of buildings. As widely observed in developing countries, houses in affected areas were usually constructed by non-professional builders, such as the homeowners themselves or villagers. While damages to traditional wooden structure were limited, unreinforced masonry and confined masonry houses,

which were constructed with modern materials, were severely damaged.

Soon after the disaster, the local government announced major initiatives and key principles for housing reconstruction in the affected area. These principles included, i) ensuring structurally safe housing reconstruction; ii) aiming for the reconstruction of permanent housing rather than temporary shelters; iii) providing direct cash transfers to residents to rebuild their homes; and iv) limiting engagement with international partners by promoting locally available human resources.

The cash transfers for residents were made based on compliance with building permit procedures and with the technical guideline called “Key Requirements”

### Technical guideline as condition of housing grant

The local government created and implemented the Key Requirements, a technical guideline for housing reconstruction, with assistance provided by JICA, and in partnership with leading engineers and academia from Gadjah Mada University and other Indonesian institutes. Key Requirements is a package of simple technical guidance, applicable only to small scale one-story houses. The Key Requirement consists of three components:

- a) quality of building materials;
- b) dimension of structural members; and
- c) appropriate joints of structural members.

The objective of the Key Requirements was to provide simplified and focused

technical guidance on structurally-critical building elements that contribute to risk reduction in non-engineered housing.

This was in response to poor construction qualities that were identified on the ground. Project members reached out to the majority of local builders, including non-professional builders and owners.

JICA took the initial step in the project by supporting the provincial government in extending awareness and training efforts for the Key Requirements through the 17 designated district building-administration offices and through their formal building-permitting process, as well as by supporting information campaigns that utilized a wide range of dedicated tools, including illustrated posters, booklets, and seminars/training for housing owners, workers and local government officials.

#### A.2.11 Poster image of Key Requirements

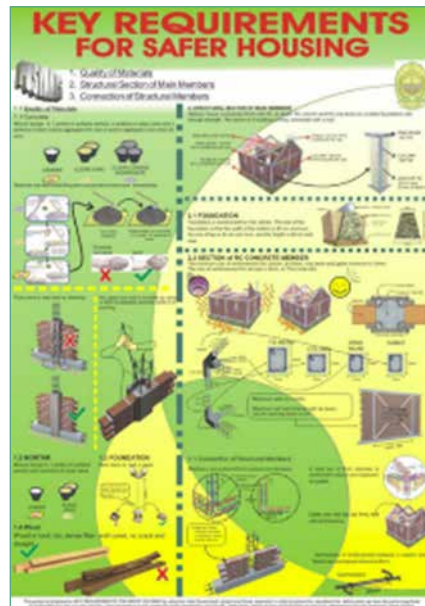

In short, a particular bold and innovative move supported by JICA during the Central Java reconstruction **was to make use of the existing formal building-administration capacity and building-permitting process to improve the quality and resilience of conventional non-engineered houses through technical guidance.** POSYANIS, which is a technical unit that was set up at 17 district building-administration offices, were tasked with providing technical guidance on the Key Requirements to beneficiaries and played a major role in

validating and administering individual cash transfers. Although this was a targeted- and temporary effort linked to the reconstruction process in Central Java, the experience contributed to a substantial leap in quality management for non-engineered houses.

### Results and lessons learned

In the end, nearly 330,000 houses<sup>1</sup> were reconstructed under the reconstruction fund and homeowners benefitted from the improved quality control mechanisms for non-engineered houses.

A.2.12  
Typical image of reconstructed house



Building on this success, the Ministry of Public Works encouraged local governments to adopt similar mechanisms to improve the quality of non-engineered houses and to provide the benefits of the reconstruction process on a larger scale. The ministry requested JICA to roll out this intervention in several more districts (Kabupaten) and cities (Kota) in each of the provinces of West Sumatra, North Sulawesi and North Sumatra, over the following six years.

To improve sustainability and to increase the impacts at the national level, JICA

A.2.13 A team of professional and non-professional builders



assisted the Ministry of Public Works in developing standard models of ordinance for provincial governments, based on the experience of the reconstruction in Central Java. They also requested their assistance in implementing dedicated outreach training programs for communities and local government officials.

The efforts in Central Java is an inspiring story about how more vulnerable forms of non-engineered housing were transformed into “more engineered” and resilient structures, leveraging existing building administration, the building-permitting process and the use of simplified technical guidelines. This experience also highlights an original idea and a potentially useful role for established building-code administrations in promoting awareness and improving the quality and resilience of non-engineered houses through a broader focus, one that includes education and guidance rather than simply police enforcement.

Moving forward, the most important thing is to continue the resilient building-construction practice in normal situations, not only after disasters. This will take time and continuous efforts, which should be part of a broader disaster-risk strategy, rather than be confined to reacting to the next disaster. And this process requires commitment of sustainable financial resources and capacity improvement, involving various actors, such as governments, communities, universities, private sectors and CBOs.

### A.2.3. El Salvador with Mexico, Japan and Peru: Regional Cooperation for development of Seismic-Resistant Construction Methods for Low-Cost Housing

#### Background

This section introduce regional cooperation to develop affordable and resilient non-engineered housing model in El Salvador supported by Mexico, Peru and

Japan. The initiative was called Project *Taishin* (a Japanese word meaning “quake resistant”), aimed at reducing disaster risk for those lived in widely constructed low-cost housing in El Salvador. This initiative was a collaborative response by Mexico, Peru and Japan to help El Salvador to reconstruct the country from the aftermath of two successive tragic earthquakes in 2001, which resulted in the casualties of over 1,000 people with extensive damage on buildings, especially on popular housing of low-income group. El Salvador was fortunate to have a sub-regional center of excellence on disaster prevention, the National Center for Disaster Prevention (CENAPRED) established in 1990 in Mexico with Japanese assistance.

Through the triangular partnership, main local counterparts including two universities and a local non-governmental foundation, El Salvador Foundation for Development and Dissemination of Housing (FUNDASAL), have jointly developed and piloted quake-resistant construction methods for popular housing with the compilation of manuals and guidelines, and have made further efforts to disseminate the methodology wider.

#### Driving force for the regional cooperation

##### Partnership evolvement

This partnership became possible because of emerged knowledge resources and institutional capacity in the region before prior to mentioned earthquake. One of the hallmarks of this triangular initiative was the proactive engagement of Mexico as the pivotal country. It was largely possible because of the expertise and preparedness which Mexico had



already accumulated through its own tragic experience of large earthquake in 1985 which killed about 10,000 people. Following the Mexican earthquake, Mexico decided to establish CENAPRED, mandated for disaster risk management, with the financial and technical assistance from the Japanese Government.

In the immediate aftermath of earthquake, the Mexican and Japanese governments dispatched a joint survey mission to El Salvador, and formed an agreement among three parties to help develop the capacity of El Salvadorian organizations to undertake the scientific seismic capacity assessment of popular low-cost housing.

In El Salvador, several low-cost housing construction methods had been available on the ground through the work of FUNDASAL, a local foundation working for low-income settlements. However, the methodologies lacked scientific analysis of seismic resistance performance capacity, which was never tested before. Therefore, three countries agreed to cooperate to test and refine these low-cost construction methods so as to disseminate the scientifically supported methodology through the reconstruction work. The partnership also leveraged experts from Peru on Adobe construction.

A.2.14 Seismic capacity experiment of a commonly used brick



Source: JICA El Salvador Office

### Achievements and Challenges

As a result of this regional partnership for El Salvador's reconstruction, following major achievements were observed:

- Scientific performance analysis was done on locally practiced low cost housing construction for the first time in El Salvador;
- The capacity of educational institutions, such as the National University of

Figure A.2.15  
Structure for Project Implementation

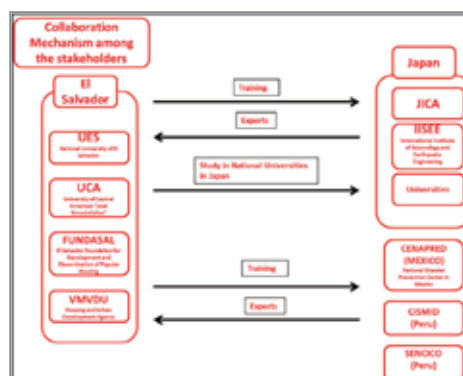

Source: Prepared by the author

El Salvador and the UCA, was well integrated to the above mentioned process, and it informed the policy level discussion;

- Low-cost housing construction techniques were refined based on the scientific analysis, and disseminated through pilot construction projects;
- El Salvador started to provide technical support to the other countries facing similar challenges (e.g. Nicaragua,

Dominican Republic and Haiti) based on the fostered capacity

- The Bureau of Housing in the Ministry of Housing and Urban Development (VMVDU), the national policy maker in the housing area, initiated to establish the Department of Standard Formulation and Investigation (UNICONS) and the El Salvador Construction Institute (ISC) to modernize the construction industry in El Salvador. The UNICONS is now playing active role to maintain and update relevant regulations and standards of low-cost house construction methods.

### Success Factors

The key success factors of this regional partnership can be analyzed as follows:

- Institutional innovations for effective knowledge transfer and mutual learning

*Strong demand of El Salvador side and matched supply of knowledge from the outside*

The desire was high to acquire “knowledge” for safe quake-resistant housing in the post-disaster period, matched by the supply of knowledge by Mexico, Japan and Peru. Moreover, Mexico had acquired and localized the knowledge assisted by Japan over the years following their tragic experiences of huge earthquakes.

*Engagement of key stakeholders to support government’s agenda*

The initiative strategically engaged a wide range of stakeholders in related field to make sure the implementable mechanism on the ground. The key actors involved include VMVDU, two universities; the National University of El Salvador (UES)

and Central American University “José Simeón Cañas” (UCA), and FUNDASAL, a non-government foundation working for housing. It was very important to have the wide range of stakeholder group to ensure the government led policy was informed by scientifically supported studies with academia, and could be reached to the people by the government and CSOs.

*Institutional innovations for effective knowledge transfer and mutual learning*

One of the challenge engaging various stakeholder was a collaboration among them. This initiative set-up technical committee from the beginning to minimize the gap and risks could be caused by insufficient coordination. In this particular example, the commitment and personality of the assigned El Salvadorian coordinator made the difference, too. The suitable selection of coordinator is a key for trust building among stakeholders and smooth implementation.

### References

1. Alianza Republicana Nacionalista (2004), “*País Seguro: Plan de Gobierno 2004-2009*”.
2. Inter-American Development Bank (2001), *IDB News Release Dec 13, 2001*
3. Inter-American Development Bank (2001), *Poverty Reduction and Promotion of Social Equity: Report on Activities in the year 2000 and An Action Plan in the Areas of Special Emphasis*
4. JICA (2003), “The Undertakings of the Project *Taishin* Enhancement of Technology for the Construction of Popular Earthquake Resistant Housing in El Salvador”, *Project Assessment Report*
5. JICA (2006), *Interim Evaluation Report*

- on the Project Taishin - Enhancement of Technology for the Construction of Popular Earthquake Resistant Housing in El Salvador*
6. JICA (2008), *The Report on the Evaluation at the Time of Completing the Project Taishin Enhancement of Technology for the Construction of Popular Earthquake Resistant Housing in El Salvador*
  7. JICA (2006), *The Evaluation Report on South-South Cooperation*
  8. JICA (2010), *Investigation Report on Impact Review for the Development through Triangular Cooperation in the Central and South American and Caribbean Regions*
  9. Murota, Tatsuro and Oscar López Bátiz, 2005, "Series 3, introducing the project for providing technological cooperation to developing countries in the building and housing area. Earthquake disaster prevention project in Mexico", *JUTAKU (Housing)*, Osaka Association of Architects & Building Engineering, August. pp48-55
  10. Nonaka, Ikujiro, Ryoko Toyama and Noboru Konno (2000), "SECI, Ba and Leadership: a Unified Model of Dynamic Knowledge Creation", *International Journal of Strategic Management*, Long Range Planning, Vol.33, pp.5-34.
  11. Proyecto Taishin (2009), *Informe Final de Proyecto "Mejoramiento de la Tecnología para la Construcción y Difusión de la Vivienda Popular Sismo-Resistente Taishin"*
  12. The World Bank (2001), *Country Assistance Strategy for the Republic of El Salvador*
  13. The World Bank (2002), *El Salvador Country Assistance Evaluation*
  14. The World Bank (2008), *Progress Report on the Country Assistance Strategy for the Republic of El Salvador*

### A.3. Leveraging Academic Knowledge and Research Capacity

#### A.3.1. UNESCO International Platform for Reducing Earthquake Damage (IPRED)

##### Background

UNESCO is promoting a focus on ex-ante preparedness and enhancing the resilience of communities to cope with natural hazards in a multidisciplinary and inclusive manner, through education, using innovating scientific decision support tools, with special consideration to individual cultural context.

As consensus was made in United Nations World Conference on Disaster Reduction (WCDRR) in 2005, it is important to

improve the safety of buildings and housing as a basic and vital priority for the world's disaster reduction efforts, and thus it was proposed that a "building disaster reduction network" should be established.

##### Mission of IPRED

Following the recommendation, the first meeting to commemorate the establishment of IPRED was held in UNESCO Paris in 2008. Representatives of major earthquake prone countries such as Chile, Egypt, El Salvador, Indonesia, Japan, Kazakhstan, Mexico, Peru, Romania, and Turkey participate

in IPRED. IPRED's mission was defined to identify gaps and priorities through the sharing of scientific knowledge and experience in the field of seismology and earthquake engineering, and to support the development of political will and public awareness, for the purpose of

ensuring the better preparation against earthquakes and building a culture of safety for the people in the world.

(<http://www.unesco.org/new/en/natural-sciences/special-themes/disaster-risk-reduction/geohazard-risk-reduction/networking/ipred/>)

Figure A.3.1. IPRED Network and Action Plan

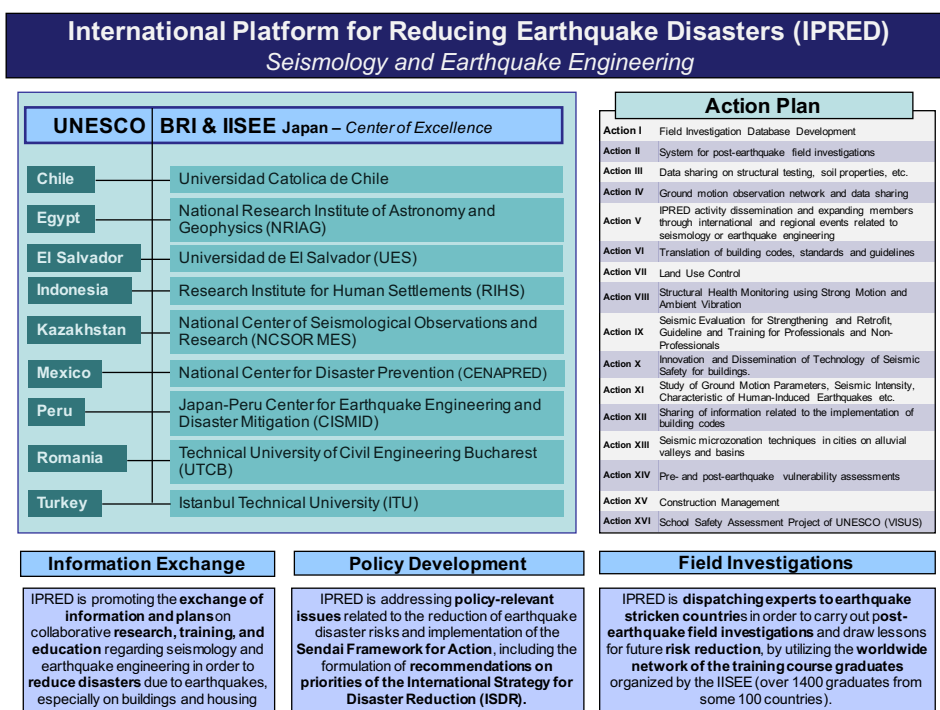

## Recent major activities

### 3-1) Post-disaster Field Investigation

One of the major activities under IPRED is to dispatch global experts for post-earthquake field investigation, per coordination with governments of receiving countries. The field investigation aims: to provide technical support to affected countries in need of scientific facts that could be further utilized for reconstruction and long-term preventive

measures and policies; and to share scientific findings and lessons with other earthquake-prone countries for future disaster risk reduction. As far, IPRED has undertaken two missions in Van, Turkey in 2012 and Bohol, the Philippines in 2013.

### Knowledge Hub for non-engineered construction

In August 2014, IPRED published "Guidelines for Earthquake Resistant Non-engineered Construction" (A.3.3).

Majority of buildings, particularly residential buildings, in developing countries are so called non-engineered buildings that often cause severe damage to both human and properties in earthquake events. The publication

aims to provide guidance for policy makers and leading engineers dedicated for improving the resilience of non-engineered construction through policies development.

**Figure A.3.2 Post-earthquake field investigation in Bohol, the Philippines, February 2014, members from Japan, Kazakhstan and UNESCO**



**Figure A.3.3 Guidelines for Earthquake Resistant Non-engineered Construction published in August 2014**

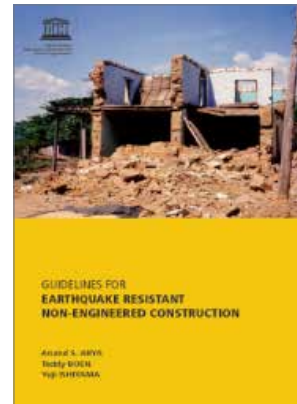

[http://www.unesco.org/new/en/natural-sciences/about-us/single-view/news/new\\_guidelines\\_to\\_improve\\_the\\_safety\\_of\\_informal\\_buildings/#.Vq34oE1MpMu](http://www.unesco.org/new/en/natural-sciences/about-us/single-view/news/new_guidelines_to_improve_the_safety_of_informal_buildings/#.Vq34oE1MpMu)

## A.3.2 UNISDR Asia Science Technology Academia Advisory Group (ASTAAG)

### 1) Background

Science and Technology for disaster risk reduction has always been there in some form in different countries. Through the advancement of scientific research, disaster risk reduction has been benefitted, especially in terms of early warning system, to identify risk in both spatial and temporal scale, strengthening of buildings and infrastructures for different types of hazards. There have also been achievements in recognizing higher

education in disaster risk reduction, either as a specialized subject and/or integration of the disaster studies into other higher education curriculum. In recent years, apart from hard science, which is more on innovations and engineering, soft science or social sciences have also got prominence and importance. Through different major disasters, it has been realized that there needs to be a good balance between the hard and soft technology, and engineering solutions and social solutions. This section will introduce the newly established academic group for disaster risk reduction, called "Asia Science Technology Academia Advisory Group".

## Science, technology and academia role and engagement during the International Decade for Natural Disaster Reduction (IDNDR)

The relation of science and technology in a formal way in inter-governmental issues dates back in 1980s, when Frank Press, then President of International Association of Earthquake Engineering [IAEE] perceived the idea of an international decade of disaster reduction. The basic idea behind this proclamation of the Decade (1990-1999) was and still remains to be the unacceptable and rising levels of losses, which disasters continue to incur on the one hand, and the existence, on the other hand, of a wealth of scientific and engineering know-how which could be effectively used to reduce losses resulting from disasters. The 1987 UN General Assembly Declaration (UN 1987):

*“...calls upon all Governments to participate during the decade for concerted international action for the reduction of natural disasters and, as appropriate, to establish national committees, in co-operation with the relevant scientific and technological communities, with a view to surveying available mechanisms and facilities for the reduction of natural hazards, assessing the particular requirements of their respective countries or regions in order to add to, improve or update existing mechanisms and facilities and develop a strategy to attain the desired goals.”*

During the IDNDR, Science and Technical Advisors [STA] group was formed to support: “

*Application of scientific knowledge*

*and technology for disaster prevention, preparedness and mitigation, including the transfer of experience and greater access to relevant data.”*

In the concluding year of the IDNDR, the Geneva Program Forum has identified the progress of Science and Technology research as (UN 1999):

*“substantial progress has been achieved in understanding the cause and effects of natural hazards. Nevertheless, further efforts are needed, especially with respect to risk assessment and warnings. Multidisciplinary efforts are needed for many problems, especially to better integrate physical and social sciences.”*

IDNDR had been able to enhance the raise the awareness of disaster issues of the national and local governments, highlighted the need of pre-disaster preparedness, and emphasized roles of different stakeholders, including the science, technology and academia sector.

## Hyogo Framework for Action and role of science, technology and academia in Asia

Following the establishment of the ISDR (International Strategy for Disaster Reduction) in year 2000, there has been more focus on regional level collaboration and networking, while keeping the global agenda in perspective. The key change from IDNDR to ISDR was to develop a comprehensive framework of disaster risk reduction [focusing on “risk reduction” issues], to identify priorities, and to measure the periodic progress. The Hyogo Framework for Action [2005-2015] had five key priorities. A quick look at the priorities

of HFA document (UN ISDR, 2005) reveals a strong role of science and technology in Priority 2 (Identify, assess and monitor disaster risks and enhance early warning), as mentioned below:

*“Support the improvement of scientific and technical methods and capacities for risk assessment, monitoring and early warning, through research, partnerships, training and technical capacity-building. Promote the application of in situ and space-based earth observations, space technologies, remote sensing, geographic information systems, hazard modeling and prediction, weather and climate modeling and forecasting, communication tools and studies of the costs and benefits of risk assessment and early warning.”*

During the HFA implementation, science and technology sectors have observed increasing demands in the disaster risk reduction both at the global and regional levels. However, its national prominence was missing, except a few selected countries. Thus, the upcoming years need to focus on:

- To bring science into national and local government decision making in the Asian countries
- To encourage innovative research and education linked to field practices

#### Related global and regional initiatives

The IDRC (International Disaster Risk Conference) Davos meeting of 2014 has analyzed and presented some key issues on the current status of Science and Technology [S-T] in disaster risk reduction (IDRC 2014). It emphasized the need of shift to “science of how” from “science

of what”, so that necessary skills and knowledge bases are properly utilized, and meet the “last mile” challenge of risk reduction.

The “Tokyo Conference on International Study for Disaster Risk Reduction and Resilience” called on policymakers to empower their national DRR platforms through greater engagement with science and technology. The “Tokyo Statement” outcome document specifies that Governments need to empower national platforms so that they can practice evidence-based disaster risk reduction for sustainable development (Tokyo Statement 2015).

In a recent report of Science and Technology Advisory Group [STAG] of UN ISDR (STAG 2015), it is mentioned that:

*“While political leadership and community partnerships are required for the successful implementation of effective, science-informed initiatives, the research community has a responsibility to formulate applicable methodologies and tools that respond to real-world challenges”.*

STAG proposed the following six areas as highlights of the post HFA framework:

*“(1) Assessment of the current state of data, scientific knowledge and technical availability on disaster risks and resilience (what is known, what is needed, what are the uncertainties, etc.);*

*(2) Synthesis of scientific evidence in a timely, accessible and policy-relevant manner;*

*(3) Scientific advice to decision-makers through close collaboration and dialogue to identify knowledge*

needs including at national and local levels, and review policy options based on scientific evidence; and

(4) Monitoring and review to ensure that new and up-to-date scientific information is used in data collection and monitoring progress towards disaster risk reduction and resilience building.

(5) Communication and engagement among policy-makers, stakeholders in all sectors and in the science and technology domains themselves to ensure useful knowledge is

identified and needs are met, and scientists are better equipped to provide evidence and advice;

(6) Capacity development to ensure that all countries can produce, have access to and effectively use scientific information.”

## Sendai Framework for Disaster Risk Reduction

The Sendai Framework for Disaster Risk Reduction (SFDRR, 2015) has seven specific goals and four key targets to achieve those goals.

Goals	Key Targets
<ul style="list-style-type: none"> <li>▪ Reduce global disaster mortality</li> <li>▪ Reduce number of affected people</li> <li>▪ Reduce direct disaster economic loss</li> <li>▪ Reduce disaster damage to critical infrastructures</li> <li>▪ Increase number of countries with DRR strategies</li> <li>▪ Enhance international cooperation</li> <li>▪ Increase access to multi hazard EWS, risk information and assessment</li> </ul>	<ol style="list-style-type: none"> <li>1. Understanding disaster risk</li> <li>2. Strengthening disaster risk governance</li> <li>3. Investing in risk reduction</li> <li>4. Enhancing disaster preparedness for collective response, and to “build back better” in recovery, rehabilitation and reconstruction</li> </ol>

Figure 1 shows a schematic diagram of relative roles of stakeholder engagements. A quick analysis shows that the Priority 1 has a strong role of S-T community in the following areas:

- **National and local levels:** Data generation and management, Baseline survey to measure progress, Hazard, risk and vulnerability maps, GIS data bases, Good practices, training and education, Dialogue and cooperation of ST communities and policy makers, science-policy interface, Strengthen technical and scientific capacity, Promote investment in innovations and technology development, and Incorporate disaster risk knowledge in formal and non-formal education.
- **International and regional levels:** Development and dissemination of

science based methodologies and tools, ST and academia partnership, Enhancing ST work on DRR through existing networks and research institutions with support of ISDR STAG.

In contrast, in Priority 2 area, roles of S-T are limited to:

- Promote the development of quality standards, such as certification and awards for DRM with private sectors, civil societies, professional association and scientific organization and UN [national and local levels] and
- Promote mutual learning and exchange of good practices and information through inter-alia, voluntary, self initiated peer review among interested states [international and regional levels]



For Priority 3, S-T roles are:

- Promote disaster risk resilience of work place through structural and non-structural measures, and Encourage the revision of existing or new standards, codes, rehabilitation or reconstruction practice [at national and local levels] and
- Promote academic, scientific and research entities and networks and private sectors to develop new products and services to help reduce disaster risk [international and regional levels]

In case of Priority 4, S-T roles are:

- Develop guidance for preparedness and reconstruction [land use planning, structural standards improvements and learning from recovery] [at national and local levels] and
- Promote further development and dissemination of instruments as standards, codes, operational guides and other guiding instruments [international and regional levels]

Figure A.3.2. Relative level of engagement of S-T in SFDRR priority areas

Priority Areas	Relative level of engagements				
1. Understanding disaster risk [Assessment, data, baseline, capacity]	High	High	High	High	High
2. Strengthening disaster risk governance [standards, certification, capacity building]	High	High	Medium	Medium	Medium
3. Investing in disaster risk reduction [innovative products with private sector]	High	High	High	High	Medium
4. Enhancing disaster preparedness [guidance, instruments]	High	High	Medium	Medium	Medium

### Formation of Science Technology Academia Stakeholder Group in Asia

In regional level in Asia, the Science Technology and Academia [STA] stakeholder group has been part of the ISDR Asia Partnership. The core area of interest and work of the group is to increase support for research and academia related to DRR to be encouraged, supported and implemented across all geographic levels. This should be done in an integrated fashion to support sustainable development, augment existing activities and mechanisms as well as support new activities that adopt a trans-disciplinary approach.

The 6<sup>th</sup> AMCDRR [Asian Ministerial Conference on Disaster Risk Reduction] in Bangkok, the voluntary commitment of the STA stakeholder group has identified following key objectives where STA can play important roles (AMCDRR 2014):

- **Research:** Promote, prioritize and advance research on natural, social, engineering and technology aspects of disaster risk in an integrated environment; enhance team efforts in hazard and disaster monitoring and research, building on existing networks, universities and initiatives; and integrating various stakeholder needs on all levels.

- **Higher education:** Strongly promote multi-disciplinary disaster risk reduction in university education as well as professional training. This will ensure human resource development in the DRR field.
- **Integration:** Ensure that disaster research programs, policies, and applications are integrated across disciplines, and contribute to enhancing policy-making and capacity building for the effective DRR and sustainability.
- **Global Standards:** Develop and coordinate globally standardized open source information and data, event documentation and analysis procedures, guidelines and frameworks for integrated and effective disaster risk management and sustainable development.
- **Awareness:** Raise awareness of decision-makers and the public by promoting effective, integrated, demand-driven, evidence-based disaster risk initiatives and increased advocacy.
- **Increase Funding:** Motivate funding sources (public, private, humanitarian, development, scientific, etc.) to allocate priority funding to address the urgent need for applied and basic integrated research on disaster risks.

The statement [AMCDRR 2014] has also identified short, medium and long term priorities on number of universities providing higher education in the region, attempt to increase research funding from the countries, enhance the effectiveness of early warning system to reach the most needy people.

While there has been increasing interest among the science technology academia communities to be part of the national and /or regional process of disaster risk reduction [as evidenced from the HFA implementation], still there are remaining challenges to bring science into decision making or policy making at the national level, and implementation in the local level. Therefore, an advisory group, named "Asia Science Technology Academia Advisory Group" was formed in May 2015, and was approved in the ISDR Asia Partnership meeting in Bangkok in June 2015. The advisory group have eight members from Asian countries. The key purpose was to bridge the gap between regional discussion to national and local policy making, decision making and implementation.

### Actions

Several potential actions, which the S-T Advisory Group for Asia Pacific will undertake, are as the following. Priorities will be different in different countries based on the country condition. A review will be made to the voluntary commitments of the 6<sup>th</sup> AMCDRR S-T stakeholder group, and revisions or additions will be made on the course of actions.

1. Establish / Promote Science Technology National Focal Group:  
Several countries have already S-T advisory groups, which needs to be re-focused or needs promotion in the national DRR priorities. Promotion will also ensure the focal group has enough resources both in terms of financial as well as technical. Policy

- advocacy and informed decision making would be the key target of this group.
2. Science Technology Advancement Index: A composite indicator would be developed to measure the S-T progress in the Asia Pacific region, in terms of an index system. This will be linked to periodic monitoring, possibly coinciding with the SFA monitoring system.
  3. Science Technology Databases: Disaster Reduction Hyper-base [DRH] is an existing database of different types of technologies in the field of disaster risk reduction. This database can be enhanced, updated and enlarged for wider usage.
  4. Professional development and higher education: Several universities in Asian regions are promoting higher education as well as professional development programs in DRR. Efforts will be made to link these initiatives and to ensure certain levels of quality control.
  5. Using social media to link S-T to actions: Role of social media becomes important to disseminate knowledge and information of S-T and to break the digital divide. Proactive use of social media and/or SNS [Social Networking System] would be done to share knowledge and information.
- and practice, IDRC Davos Summary report, 16 pages
3. SFDRR (2015): Sendai Framework for Disaster Risk Reduction, 2015-2030, 25 pages
  4. STAG (2015): Science is sued for disaster risk reduction: UN ISDR Science and Technology Advisory Group Report, 50 pages.
  5. Tokyo Statement (2015): Tokyo Statement: Towards a new science and technology to consolidate disaster risk reduction and sustainable development, Science Council of Japan, UNISDR, IRDR and University of Tokyo
  6. UN (1987): United National General Assembly Resolution A/RES/42/169
  7. UN (1999): United National General Assembly 44<sup>th</sup> Session, Report of the Secretary General, A/54/132 - E/1999/80
  8. UNISDR (2005): Hyogo Framework for Action 2005-2015: Building the resilience of nations and communities to disasters, 22 pages.

## References

1. AMCDRR (2014): Statement of Voluntary Commitments of Asia Science, Technology and Academia Stakeholder Group for the 6<sup>th</sup> Asian Ministerial Conference for Disaster Risk Reduction, Annex 10, Bangkok
2. IDRC (2014): Integrative disaster risk management: role of science technology



United Nations  
Educational, Scientific and  
Cultural Organization



# Natural Sciences Sector



9 789231 001741