

2015 Earthquake Damage Mapping

Hanuman Dhoka Darbar Square Monument Zone
Kathmandu Valley World Heritage Property



Submitted to UNESCO by

Ram Sharan Bhuju (Architect) | Renu Maharjan (Architect) | Ashwin Poudel (Engineer) | Manjari Shakya (Architect)

December 2015

This assessment was supported by
UNESCO Office in Kathmandu

Cover: Areal photograph of Hanuman Dhoka Darbar Square, courtesy Skycatch, 2015

All other photographs and drawings unless marked otherwise by:
Ram Sharan Bhujju, Renu Maharjan, Ashwin Poudel, Manjari Shakya, Sharad Man Shakya,
Hanuman Dhoka Palace Museum, Department of Archaeology, 2015

TABLE OF CONTENTS

Introduction	5	39. Nava Jogini House	86
PART A: Monuments	9	40. Bhagwati Temple	87
1. Makhan Bahil	10	41. Kumari Shrine	88
2. Tarini Devi Temple	12	42. Narayan Temple	89
3. Kalika Temple	16	43. Joshi Agam Chhen	90
4. Mahendrashwor Mahadev	17	44. Maju Dega	91
5. Pancha Mukhi Laxmi Narayan	24	45. Garud Narayan Temple	93
6. Mahadev Temple	30	46. Ashok Binayak	95
7. Kageshwar Temple	31	47. Durga Temple	100
8. Mahadev Temple	33	48. Agan Dyo	102
9. Mahadev Temple	34	49. Shivalinga	104
10. Taleju Bhawani Temple	36	50. Kasthamandap	107
11. Bhudhanilkantha Narayan	40	51. Mahadev	109
12. Mahadev	46	52. Silyan Sata House	112
13. Dashain Ghar	51	53. Dhansa Temple	113
14. Mulchowk	53	54. Bimaleshwor Mahadev	114
15. Panchamukhi Hamuman	54	55. Narayan Temple	115
16. Nasal Chowk	55	56. Sikamu Bahal	118
17. Basantapur Bhawan	56	57. Kumari Bahal	122
18. Lalitpur Bhawan	57	58. Kumari Dyochhen	124
19. Bhaktapur Bhawan	58	59. Baniya Bahal	125
20. Kritipur Bhawan	59	60. Saraswati Temple	126
21. Lohan Chowk	60	61. Krishna Temple	127
22. Narsingh Image	62	62. Stupa	128
23. Aagan Temple	63	63. Mashan Chowk	130
24. Mohan Chowk	64	64. Dakh Chowk	132
25. Sundari Chowk	65	65. Bayu Chowk	134
26. Hanuman Image	66	66. Gaddi Baithak	136
27. Jagannath Temple	68	67. Guarding Lions	138
28. Gopinath Temple	71	PART B: Residential Buildings	141
29. Mahadev Chaitya	72	1. Zone A	143
30. Kal Bhairab	73	2. Zone B	167
31. Laxmi Narayan Temple	74	3. Zone C	183
32. Degu Talle Temple	75	4. Zone D	199
33. Sweta Bhairab Temple	77	PART C: Public Buildings	205
34. Chasisn Dega Temple	78		
35. Saraswati Temple	81		
36. Krishna Temple	82		
37. Taga Gan	83		
38. Layaku Bahi	84		

INTRODUCTION

The earthquake of 25th April and 12th May 2015 has caused extensive damages in Nepal. The oldest buildings were especially affected, along with all the sites enlisted as World Heritage by UNESCO. The objectives of this study are thus, to make a record of all the large and small monuments in the site and the extent of damages for easy understanding and overall cost estimation for future work; and also to facilitate the work of restoration and reconstruction by making a record of remaining present structures and identifying general and unique problems.

We, thus started to begin by conducting an expertise campaign in the field, articulated as follows:

1. Identification of each building and independent remarkable entities by an inventory numbers on a map
2. Location of damage grade using colour coding. These colour coded maps allows a graphical understanding of the damage on all the studied UNESCO sites.
3. Compilation of a photographic inventory of all the accessible facades to allow future restoration or reconstruction of buildings in respect to their original essence (if not the exact restitution).
4. Description and a rapid diagnostics of all the buildings in coherence with their names, structural system, construction materials, relative position, number of floors; and in the case of religious buildings typology and approximate height.
5. The nature of the observed damage, possible destruction, the risk of immediate danger and the existence of specific elements to safeguard (especially carved wooden structures). These diagnostics are illustrated furthermore by the photographs of the described problems along with the photographs in original form ie, before earthquake.

Two separate inventories are drawn in parallels, one for monumental heritage ie, all public or religious buildings (where the heritage integrity is of prime importance) and the other for living heritage ie, residential buildings (with the concept of dangerousness as predominant characteristics). We believe that Monumental Heritage and Living heritage must be conserved in different approach to maintain its original identity.

This report includes the damage inventory of core area of Kathmandu Durbar Square Monument zone.

Report Organization

The report has been divided into 3 parts:

Monuments

There are 61 monuments listed in the Carl Pruscha's inventory from 1975. This assessment includes also smaller monuments and religious structures of historic importance

Residential Buildings

No proper inventory of private houses in the Monument Zone has been produced so far and little is known about the heritage value of private dwellings. Hence, this assessment includes a survey of all private dwellings in the Core Zone so that they can be categorized further and proper actions could be taken to conserve them.

Public Buildings

There are some buildings used for public purpose like schools, restaurants, shops etc. Inventory and damage assessment of such buildings were also taken in to account as they define the space which it surrounds.

The numbering of the religious monument is done in accordance to the 1972 inventory by Carl Pruscha. The additional monuments were added with a,b,c... and so on according to the proximity to the main monument mentioned. Besides, some other monuments which were not mentioned in the previous inventory is numbered later.

The settlement area is further divided into zones A, B, C and zones D and E consists of public buildings.







Limitations

Some areas of the Palace such as Dhukuti area were not inventorized as we could not accessed them. The interiors of several delipated buildings could not be accessed due to safety concerns. Photographs of Trishul chowk and Taleju area from inside the chowk are prohibited hence assessment is limited to map form and description.









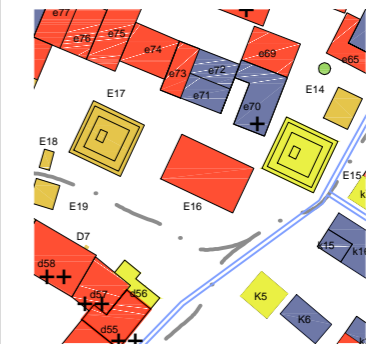

Hanuman Dhoka Darbar Square Monument Zone
 The black line defines the Core Zone Boundary, the dotted blue line the Buffer Zone Boundry

LEGEND

-  Photos taken before the earthquake
-  Photos taken after the earthquake
-  totally collapsed building
-  1/2  half collapsed building
-  danger of falling building
- A01 Block code Building number
- 01 a Monument Number

MAP LEGEND



- location plan
- 17 dwellings
- 17 public / religious buildings
-  H platform cracks
-  no visible damage
-  light damages
-  repairable damages
-  threatened / dangerous
-  collapsed
-  outside diagnostic

HANUMAN DHOKA DURBAR SQUARE

MONUMENT ZONE

Monuments Listed in Nomination Document

1. Makhn Bahil, 1848
2. Tarini Devi Temple
3. Kalika Temple
4. Mahendreshwor Mahadev Temple, 1962
5. Pancha Mukhi Lakshmi Narayan Temple
6. Mahadev Temple, 1746
7. Kageshwar Temple
8. Mahadev Temple, 17th c.
9. Mahadev Temple, 17th c.
10. Taleju Bhawani Temple, 1576
11. Budhanilkantha Narayan Image, 16th c.
12. Mahadev Temple, 17th c.
13. Dasain Ghar Temple, 19th c.
14. Mul Chok, 16th c.
15. Pancha Mukhi Hanuman Temple, 16th c.
16. Nasal Chok, 17th c.
17. Basantapur Bhawan, 1770
18. Lalitpur Bhawan, 1770
19. Bhaktapur Bhawan, 1770
20. Kirtipur Bhawan, 1770
21. Lohan Chok, 1770
22. Narsingh Image, 1673
23. Aagan Temple
24. Mohan Chok, 1648
25. Sundari Chok, 1649
26. Hanuman Image, 1672
27. Jagannath Temple, 17th c.
28. Gopinath Temple, 17th c.
29. Mahadev Chaitya, 17th c.
30. Kal Bhairab Shrine, 1660

31. Lakshmi Narayan Temple, 1660
32. Degu Talle Temple
33. Sweta Bhairab Temple, 1795
34. Chasin Dega Temple, 1649
35. Saraswati Temple, 18th c.
36. Krishna Temple, 18th c.
37. Taga Gan Bell, 1779
38. Layaku Bahil
39. Nava Jagini House
40. Bhagvati Temple, 1756
41. Kumari Shrine
42. Narayan Temple
43. Joshi Aagan Temple
44. Maju Dega Temple, 1692
45. Garuda Narayan Temple, 16th c.
46. Ashoka Binayak Temple
47. Durga Temple
48. Aagan Dyo - Agamhouse, 19th c.
49. Shivalinga Temple
50. Kastha Mandap Temple, 1620
51. Mahadev Temple, 1673
52. Silyan Sata House
53. Dhansa Temple, 1673
54. Bimalleshwar Mahadev Shrine, 1693
55. Narayan Temple, 1690
56. Sikhamu Bahal
57. Kumari Bahal, 18th c.
58. Kumari Dyochhen, 18th c.
59. Bania Bahal
60. Saraswati Temple
61. Krishna Temple

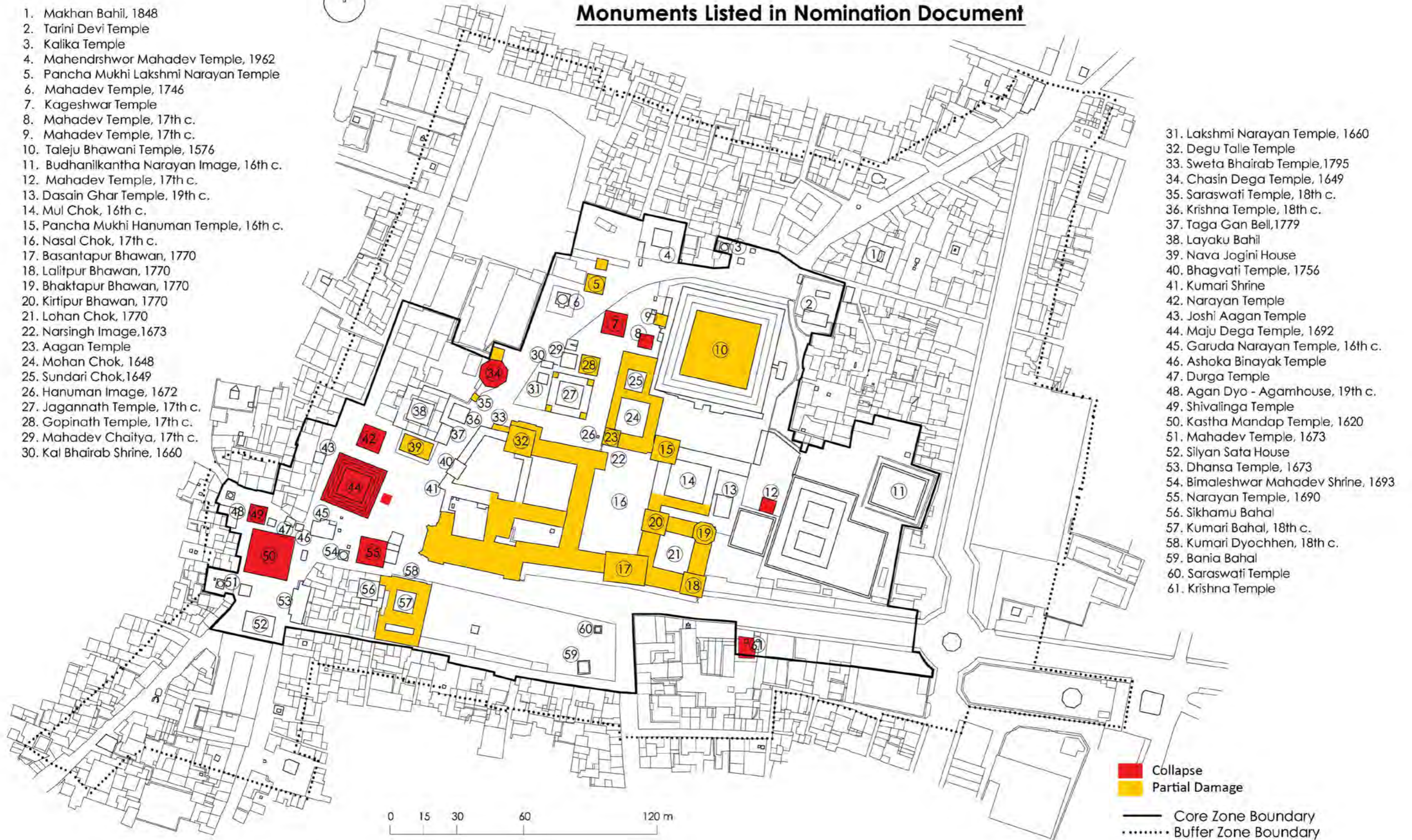

MONUMENTS

1 MAKHAN BAHIL



CODE NO	TYOLOGY	MONUMENT NAME	ESTABLISHED/ RENOVATED	STRUCTURAL SYSTEM	MATERIAL	GENERAL DESCRIPTION	PROBLEM DESCRIPTION	DANGER	REMARKS
1	Bahal courtyard with shrine	Makhan Bahil	1827, after 1934 & 2013 B.S as per inscrption	Frame	Brick	G+4.5/courtyard with 8 votive chaityas, a mandala stone & the shrine with torana of manjusri	No visible damage		



1a, 1b, 1c, 1d, 1e, 1f, 1g, 1h 1i, 1j



CODE NO	TYOLOGY	MONUMENT NAME	ESTABLISHED/ RENOVATED	STRUCTURAL SYSTEM	MATERIAL	GENERAL DESCRIPTION	PROBLEM DESCRIPTION	DANGER	REMARKS
1a, 1b, 1c, 1d, 1e, 1f, 1g, 1h	Chaitya				Stone	stone chaitya	No visible damage		
1i	Mandap						No visible damage		
1j	Stone lions								



2 TARANI DEVI TEMPLE



CODE NO	TYOLOGY	MONUMENT NAME	ESTABLISHED/ RENOVATED	STRUCTURAL SYSTEM	MATERIAL	GENERAL DESCRIPTION	PROBLEM DESCRIPTION	DANGER	REMARKS
2	Single Storey Temple	Tarani Devi Temple (Tana Devi Temple)	Older Than Taleju/eleveth century Licchavi King Shankara Deva.	Load Bearing	Brick	worshipped every 14th day of the lunar calendar, open to visitors on Mha Puja during Tihar festival, Back part renovated before 1 year before Earthquake	West face bricks out of face, Door half collapsed, rising damp		



2a, 2b, 2c, 2d, 2e



CODE NO	TYOLOGY	MONUMENT NAME	ESTABLISHED/ RENOVATED	STRUCTURAL SYSTEM	MATERIAL	GENERAL DESCRIPTION	PROBLEM DESCRIPTION	DANGER	REMARKS
2a	Mandapa						stone deleated		
2b	open shrine	ganesh			Stone	stone idol on wall	No visible damage		
2c	open shrine	Bhimsen			Stone	stone idol on wall	No visible damage		
2d	open shrine				Stone	stone idol on wall	No visible damage		
2e	Gate				Stone	gate with two stone lion	stone idols dilapadated		



2f, 2g, 2h



CODE NO	TYOLOGY	MONUMENT NAME	ESTABLISHED/ RENOVATED	STRUCTURAL SYSTEM	MATERIAL	GENERAL DESCRIPTION	PROBLEM DESCRIPTION	DANGER	REMARKS
2f	open shrine	Bishnu			Stone	stone idol on wall	No visible damage		
2g	open shrine								
2h	open shrine	Narayan with Garuda			Stone	open shrine	vertical crack on northern part		

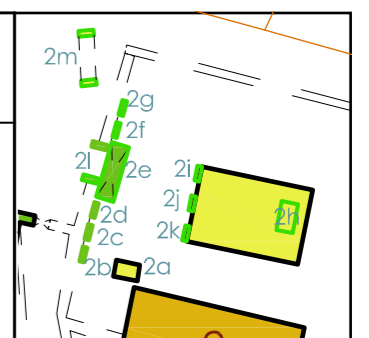

2i, 2j, 2k, 2l, 2m



CODE NO	TYOLOGY	MONUMENT NAME	ESTABLISHED/ RENOVATED	STRUCTURAL SYSTEM	MATERIAL	GENERAL DESCRIPTION	PROBLEM DESCRIPTION	DANGER	REMARKS	
2i	open shrine	Matye Narayan					No visible damage			
2j	open shrine	Swasthani					No visible damage			
2k	open shrine	Laxmi Narayn					No visible damage			
2l	stone lion					coloured, carved by grill	No visible damage			
2m	stone lion					stone delipated	No visible damage			

3 GANESH TEMPLE



3b KALIKA TEMPLE



CODE NO	TYOLOGY	MONUMENT NAME	ESTABLISHED/ RENOVATED	STRUCTURAL SYSTEM	MATERIAL	GENERAL DESCRIPTION	PROBLEM DESCRIPTION	DANGER	REMARKS
3	Two storey temple	Ganesh Temple		Load Bearing	Brick	Two tiered temple	Base bricks degraded on east		
3a	Two storey temple	Bishnu Temple		Load Bearing	Brick	Two tiered temple	Bell on south missing, no visible damage on temple		
3b	Single storey temple	Kalika temple		Load Bearing	Brick	other idol is wall	rising damp wall , covered with rubbles, stone lions scattered		



4 MAHENDRASHWOR MAHADEV TEMPLE



CODE NO	TYOLOGY	MONUMENT NAME	ESTABLISHED/ RENOVATED	STRUCTURAL SYSTEM	MATERIAL	GENERAL DESCRIPTION	PROBLEM DESCRIPTION	DANGER	REMARKS
4	Two Storey Temple	Mahendraswor Mahadev temple	1561 A.D/1963 A.D			The temple is dedicated to shiva in the phallic form-cladded with marble tile, cladding cracked			

4a STORE HOUSE



4b NANDI



4c KALASH



4d TRISHUL



CODE NO	TYOLOGY	MONUMENT NAME	ESTABLISHED/ RENOVATED	STRUCTURAL SYSTEM	MATERIAL	GENERAL DESCRIPTION	PROBLEM DESCRIPTION	DANGER	REMARKS
4a	single storey	Store house	2025			1st floor concrete structure	dampness , no visible damage		
4b		Nandi					No visible damage		
4c	2 kalash					covered by metal roof	brick falls on NE, SW corner missing		
4d	trishul						No visible damage		

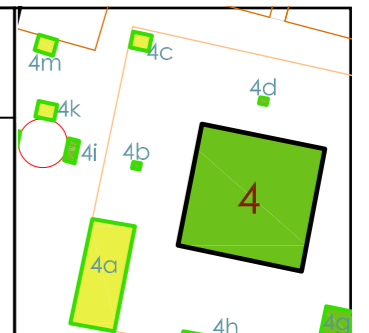

4e OPEN SHRINE



4f ENCLOSED SHRINE



4g ENCLOSED SHRINE



4h GATE

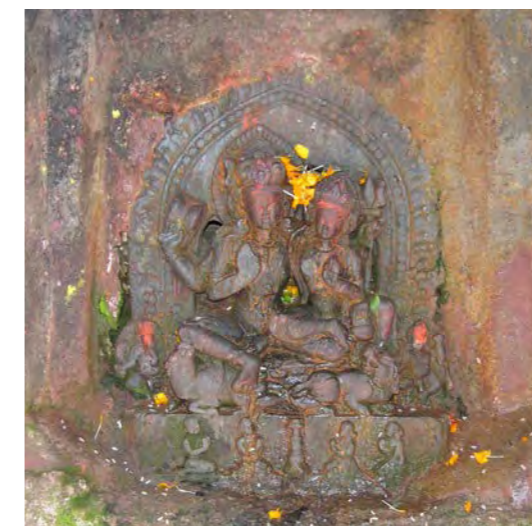

CODE NO	TYOLOGY	MONUMENT NAME	ESTABLISHED/ RENOVATED	STRUCTURAL SYSTEM	MATERIAL	GENERAL DESCRIPTION	PROBLEM DESCRIPTION	DANGER	REMARKS
4e	open shrine	shiva parbati ganesh & ..	2066 B.S			covered by metal roof	No visible damage		
4f	enclosed shrine					2 sculptures	gajur broken		
4g	enclosed shrine					No visible damage			
4h	gate					gate newly constructed	No visible damage, stone lions degraded & painted		

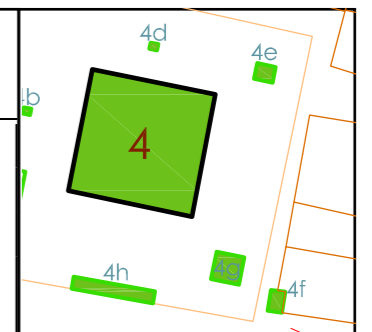

4i ENCLOSED SHRINE



4j CHAITYA



4k CHAITYA



4l CHAITYA



CODE NO	TYOLOGY	MONUMENT NAME	ESTABLISHED/ RENOVATED	STRUCTURAL SYSTEM	MATERIAL	GENERAL DESCRIPTION	PROBLEM DESCRIPTION	DANGER	REMARKS
4i	Enclosed shrine	Bishnu saraswoti &...	2056			total 5 idols, concrete roof	some tiles missing		
4j	Chaitya						Damaged by pipal tree		
4k	Chaitya						delepatated plaster		
4l	Chaitya						delepatated plaster		



4m ENCLOSED SHRINE



4n BALRAM KRISHNA TEMPLE



4o CHAITYA



4p CHAITYA



CODE NO	TYOLOGY	MONUMENT NAME	ESTABLISHED/ RENOVATED	STRUCTURAL SYSTEM	MATERIAL	GENERAL DESCRIPTION	PROBLEM DESCRIPTION	DANGER	REMARKS
4m	Enclosed shrine	Balaram Krishna Temple		Load Bearing		single storey covered by CGI sheet pinnacle missing	No visible damage		
4n			crack on west wall						
4o	Chaitya		stone member dislocating						
4p	Chaitya		stone member dislocating						

4q OPEN SHRINE

4r HAND PUMP



CODE NO	TYOLOGY	MONUMENT NAME	ESTABLISHED/ RENOVATED	STRUCTURAL SYSTEM	MATERIAL	GENERAL DESCRIPTION	PROBLEM DESCRIPTION	DANGER	REMARKS	
4q	Open shrine					plastered by cement	No visible damage			
4r	Hand pump					handpump enclosed by low wall	vegetation growth			
4s	Pati					image on west	brick degraded due to dampness, SW corner separating			

4s PATI

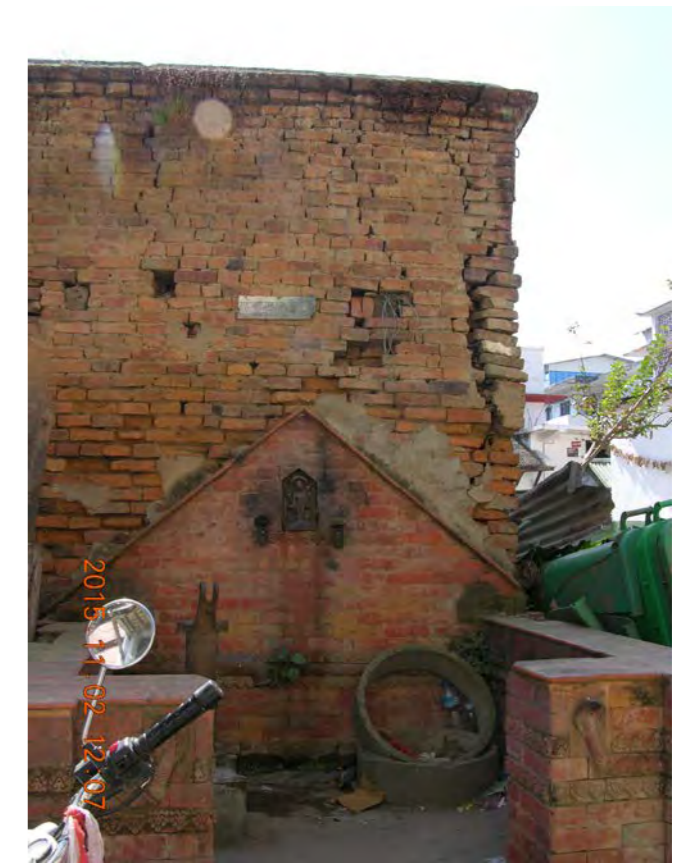

CODE NO	TYOLOGY	MONUMENT NAME	ESTABLISHED/ RENOVATED	STRUCTURAL SYSTEM	MATERIAL	GENERAL DESCRIPTION	PROBLEM DESCRIPTION	DANGER	REMARKS	
4s	Pati					image on west	brick degraded due to dampness, SW corner separating			

5 PANCHAMUKHI LAXMI NARAYAN TEMPLE



CODE NO	TYOLOGY	MONUMENT NAME	ESTABLISHED/ RENOVATED	STRUCTURAL SYSTEM	MATERIAL	GENERAL DESCRIPTION	PROBLEM DESCRIPTION	DANGER	REMARKS	
5	Two Storey temple		17th Century			Built on three step bases	major cracks all around bricks disassociating, roof tiles missing, vegetation growth on roof			

5a



CODE NO	TYOLOGY	MONUMENT NAME	ESTABLISHED/ RENOVATED	STRUCTURAL SYSTEM	MATERIAL	GENERAL DESCRIPTION	PROBLEM DESCRIPTION	DANGER	REMARKS	
5a	Two Storey and Three floor						structure incline, brick degadated			

5b SHIVA LINGA



CODE NO	TYOLOGY	MONUMENT NAME	ESTABLISHED/ RENOVATED	STRUCTURAL SYSTEM	MATERIAL	GENERAL DESCRIPTION	PROBLEM DESCRIPTION	DANGER	REMARKS	
5b	Shiva linga					Stone 4 faced shiva linga on brick base	No visible damage			

5c NIL BARAHI

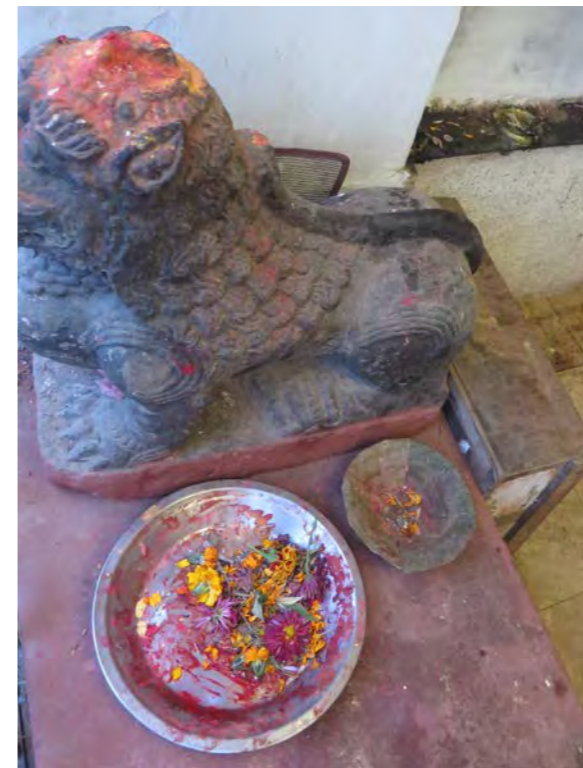

CODE NO	TYOLOGY	MONUMENT NAME	ESTABLISHED/ RENOVATED	STRUCTURAL SYSTEM	MATERIAL	GENERAL DESCRIPTION	PROBLEM DESCRIPTION	DANGER	REMARKS	
5c	Single storey temple	Nil Barahi		Load Bearing			Deteriorated roof			

5d



CODE NO	TYOLOGY	MONUMENT NAME	ESTABLISHED/ RENOVATED	STRUCTURAL SYSTEM	MATERIAL	GENERAL DESCRIPTION	PROBLEM DESCRIPTION	DANGER	REMARKS	
5d						Two storeyed building used by Police Station	Half part collapsed. Remaining structure has extensive crack.			

5e



CODE NO	TYOLOGY	MONUMENT NAME	ESTABLISHED/ RENOVATED	STRUCTURAL SYSTEM	MATERIAL	GENERAL DESCRIPTION	PROBLEM DESCRIPTION	DANGER	REMARKS	
5e	Pati					Used by Army.	Half part collapsed. Remaining structure has extensive cracks. Vegetation growth on roof. Roof tile detached.			

6 MAHADEV



CODE NO	TPOLOGY	MONUMENT NAME	ESTABLISHED/ RENOVATED	STRUCTURAL SYSTEM	MATERIAL	GENERAL DESCRIPTION	PROBLEM DESCRIPTION	DANGER	REMARKS	
6	Dome temple	Mahadev	18th century/ 1934			Temple of stone stands on a stone base in three stages, contains deity of Chaturmukhalinga	Plinth setting down, stone dislocation, vegetation growth			

7 KAGESWOR



CODE NO	TYOLOGY	MONUMENT NAME	ESTABLISHED/ RENOVATED	STRUCTURAL SYSTEM	MATERIAL	GENERAL DESCRIPTION	PROBLEM DESCRIPTION	DANGER	REMARKS
7	Composite Temple	Kvageswor					upper part collapsed, structure unstable, plinth setting & tudal out of place		
7a	Enclosed shrine						stone delipated, gajur top missing		

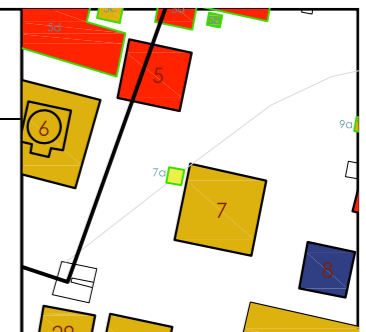

7a ENCLOSED SHRINE



CODE NO	TYOLOGY	MONUMENT NAME	ESTABLISHED/ RENOVATED	STRUCTURAL SYSTEM	MATERIAL	GENERAL DESCRIPTION	PROBLEM DESCRIPTION	DANGER	REMARKS
7a	Enclosed shrine						stone delipated, gajur top missing		



8 MAHADEV TEMPLE



CODE NO	TYOLOGY	MONUMENT NAME	ESTABLISHED/ RENOVATED	STRUCTURAL SYSTEM	MATERIAL	GENERAL DESCRIPTION	PROBLEM DESCRIPTION	DANGER	REMARKS
8	Two Storey Temple	Mahadev temple	17th century				totally collapsed		

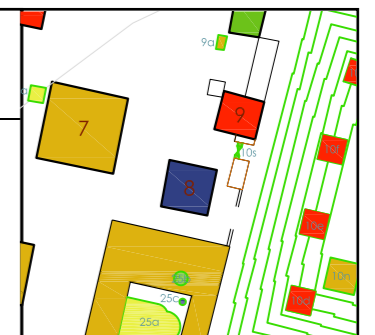

9 MAHADEV TEMPLE



CODE NO	TYOLOGY	MONUMENT NAME	ESTABLISHED/RENOVATED	STRUCTURAL SYSTEM	MATERIAL	GENERAL DESCRIPTION	PROBLEM DESCRIPTION	DANGER	REMARKS
9	Two Storey Temple	Mahadev temple	17th century			Built on a shallow base. Both door and windows contain struts which represent various forms of shiva	South wall very degraded and unstable		

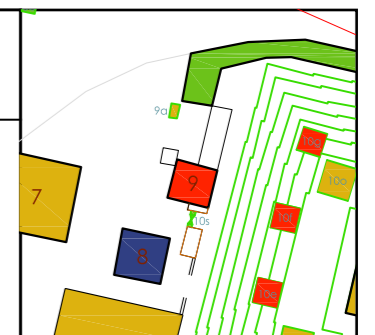

9a GORAKHNATH

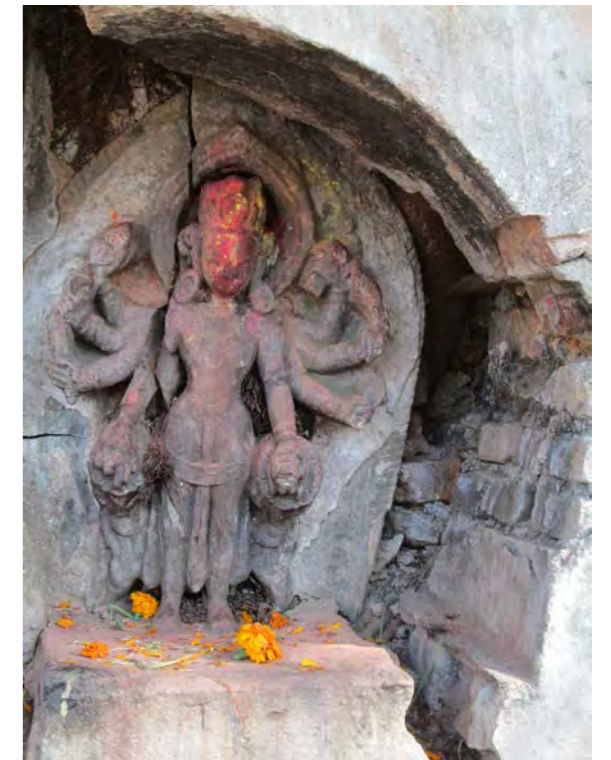

CODE NO	TYOLOGY	MONUMENT NAME	ESTABLISHED/ RENOVATED	STRUCTURAL SYSTEM	MATERIAL	GENERAL DESCRIPTION	PROBLEM DESCRIPTION	DANGER	REMARKS	
9a		Gorakhnath				Temple at bottom of peepal tree, 4 idols				

10 TALEJU TEMPLE

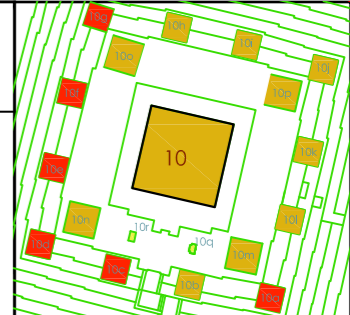

CODE NO	TYOLOGY	MONUMENT NAME	ESTABLISHED/ RENOVATED	STRUCTURAL SYSTEM	MATERIAL	GENERAL DESCRIPTION	PROBLEM DESCRIPTION	DANGER	REMARKS	
10	Three Storey Temple	Taleju Bhawani temple	1576	Load Bearing	Brick	Built on a series of brick pedestals. Consists of carved doors and metal torana	Cracks present in plinth but no visible cracks in main temple		Photographs not allowed	

10a - 10p



Source: Sharad Man Shakya
Date: 25th April 15

CODE NO	TYOLOGY	MONUMENT NAME	ESTABLISHED/ RENOVATED	STRUCTURAL SYSTEM	MATERIAL	GENERAL DESCRIPTION	PROBLEM DESCRIPTION	DANGER	REMARKS
10a, 10b				Load Bearing	Brick	Pagoda style temple on brick pedestal of Taleju.	Bricks dislocated		Photographs not allowed
10c				Load Bearing	Brick	Pagoda style temple on brick pedestal of Taleju.	Bricks dislocated and structure tilted		Photographs not allowed
10d-10p				Load Bearing	Brick	Pagoda style temple on brick pedestal of Taleju.	Bricks dislocated		Photographs not allowed

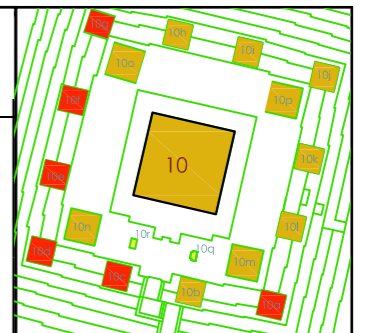

10s TALEJU GATE



CODE NO	TPOLOGY	MONUMENT NAME	ESTABLISHED/ RENOVATED	STRUCTURAL SYSTEM	MATERIAL	GENERAL DESCRIPTION	PROBLEM DESCRIPTION	DANGER	REMARKS
10s	Gate	Taleju Gate		Load Bearing	Brick	Main gate of Taleju Temple	No visible Damage		

10r, 10t - 10z'

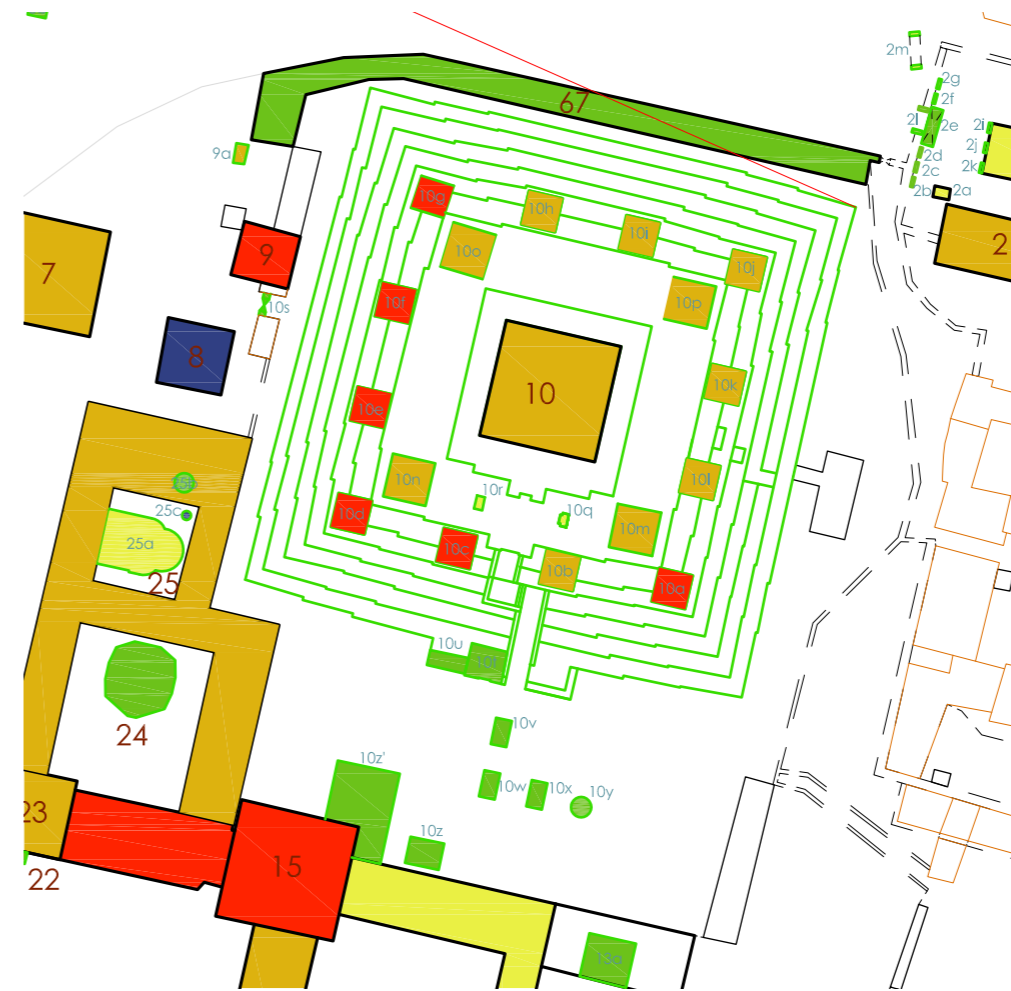

CODE NO	TYOLOGY	MONUMENT NAME	ESTABLISHED/ RENOVATED	STRUCTURAL SYSTEM	MATERIAL	GENERAL DESCRIPTION	PROBLEM DESCRIPTION	DANGER	REMARKS
10q	Jharu	Jharu			Stone, Brick	Reconstruction going on			Photographs not allowed
10r	Jharu	Jharu			Stone, Brick				Photographs not allowed
10t	Stone trishul						No visible damages.		Photographs not allowed
10u	Inscription						No visible damages.		Photographs not allowed
10v	Stone pole with image				Stone, Brick		No visible damages.		Photographs not allowed
10w	Stone pole with lion image				Stone		Slightly tilted.		Photographs not allowed
10x	Stone pole with image and tortoise base				Stone		Slightly tilted.		Photographs not allowed
10y	Well								Photographs not allowed
10z	Dome				Stone		No visible damages		Photographs not allowed
10z'	Dabali						No visible damages		Photographs not allowed

11 BUDHANILKANTHA NARAYAN



CODE NO	TYOLOGY	MONUMENT NAME	ESTABLISHED/ RENOVATED	STRUCTURAL SYSTEM	MATERIAL	GENERAL DESCRIPTION	PROBLEM DESCRIPTION	DANGER	REMARKS
11		Budhanilkantha Nrayan Image	16th century		Stone	Stone image of Vishnu in elevated platform surrounded by water, garden and other images	Good condition but minor cracks formed and boundy walls tilted		

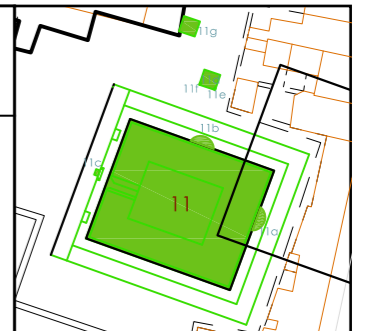

11a STONE WATER SPOUT



CODE NO	TYOLOGY	MONUMENT NAME	ESTABLISHED/ RENOVATED	STRUCTURAL SYSTEM	MATERIAL	GENERAL DESCRIPTION	PROBLEM DESCRIPTION	DANGER	REMARKS	
11a	Stone water spout				Stone		Vegetation Growth;Cracks at base			
11b	Stone water spout				Stone		Vegetation Growth;Cracks at base			
11c	Statue				Stone	Stone image in front of Budhanilkantha	Good Condition			

11b STONE WATER SPOUT



CODE NO	TYOLOGY	MONUMENT NAME	ESTABLISHED/ RENOVATED	STRUCTURAL SYSTEM	MATERIAL	GENERAL DESCRIPTION	PROBLEM DESCRIPTION	DANGER	REMARKS	
11b	Stone water spout				Stone		Vegetation Growth;Cracks at base			

11c STATUE



CODE NO	TYOLOGY	MONUMENT NAME	ESTABLISHED/ RENOVATED	STRUCTURAL SYSTEM	MATERIAL	GENERAL DESCRIPTION	PROBLEM DESCRIPTION	DANGER	REMARKS	
11c	Statue				Stone	Stone image in front of Budhanilkantha	Good Condition			

11d SINGLE STOREY TEMPLE



11e STONE STATUE



11f STONE STATUE



CODE NO	TYOLOGY	MONUMENT NAME	ESTABLISHED/ RENOVATED	STRUCTURAL SYSTEM	MATERIAL	GENERAL DESCRIPTION	PROBLEM DESCRIPTION	DANGER	REMARKS	
11d	Temple			Load Bearing	brick, timber	Temple with statue of krishna	Cracks in timber columns and wall			
11e	Stone statue				stone	Stone statue of a snake	Good Condition			
11f	Stone statue				stone	Stone statue of a snake	Good Condition			

11g OPEN SHRINE



CODE NO	TYOLOGY	MONUMENT NAME	ESTABLISHED/ RENOVATED	STRUCTURAL SYSTEM	MATERIAL	GENERAL DESCRIPTION	PROBLEM DESCRIPTION	DANGER	REMARKS
11g	Open Shrine				Stone, Brick	Rectangular area with stone sculptures.	Good Condition		



12 MAHADEV TEMPLE

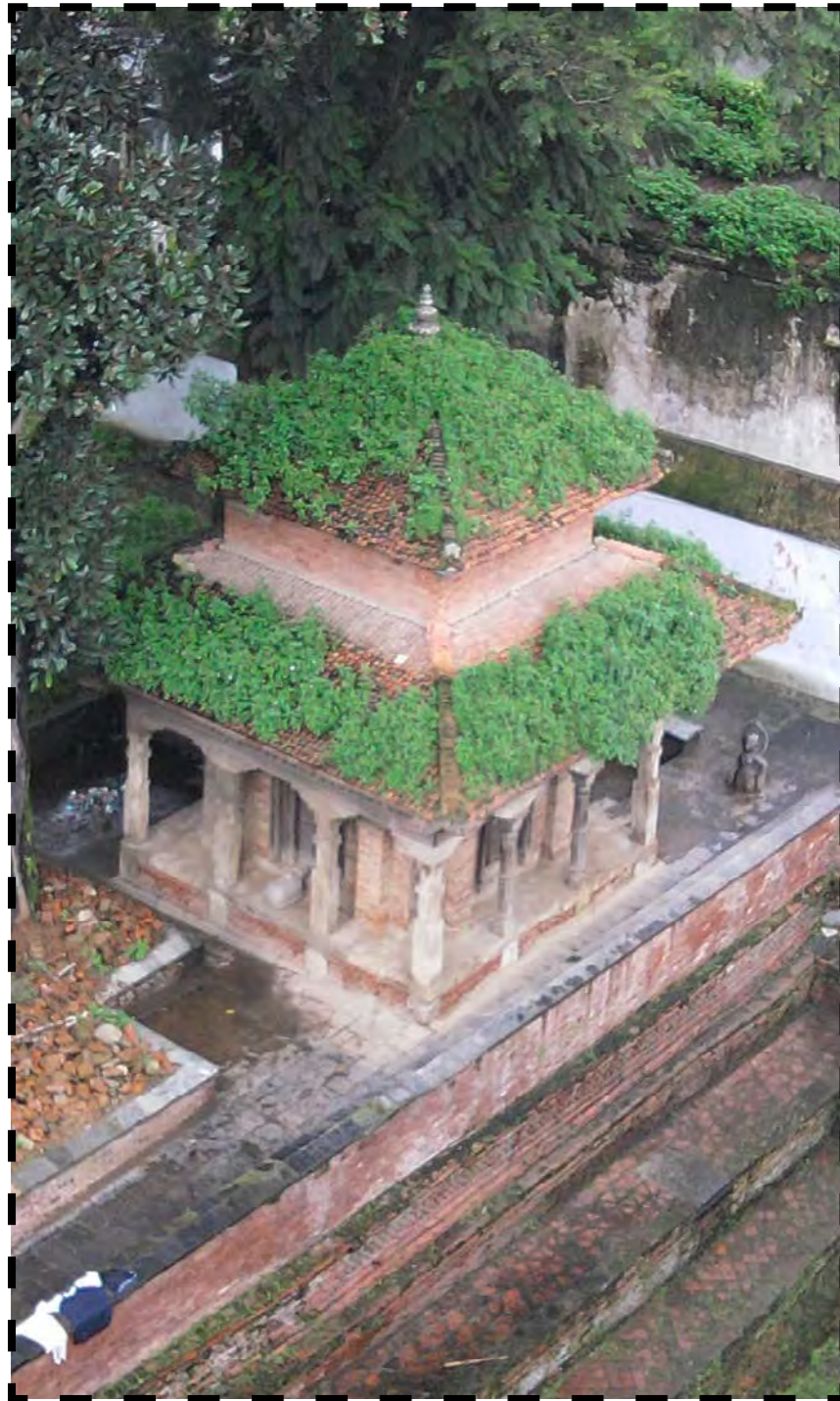

CODE NO	TYOLOGY	MONUMENT NAME	ESTABLISHED/ RENOVATED	STRUCTURAL SYSTEM	MATERIAL	GENERAL DESCRIPTION	PROBLEM DESCRIPTION	DANGER	REMARKS
12	Two storey temple	Madhev Temple	17th century	Load Bearing	Brick;Timber	Supporting pillars carved;tiled roofs	Totally Collapsed		



12a POND



CODE NO	TYOLOGY	MONUMENT NAME	ESTABLISHED/ RENOVATED	STRUCTURAL SYSTEM	MATERIAL	GENERAL DESCRIPTION	PROBLEM DESCRIPTION	DANGER	REMARKS	
12a	Pond				Stone, Brick	Wooden post at the center with metallic snake statue on top	Pillar slightly tilted and vertical cracks present at pillar base; boundry wall collapsed;			

12b ELEPHANT STATUE

12c ELEPHANT STATUE



CODE NO	TYOLOGY	MONUMENT NAME	ESTABLISHED/ RENOVATED	STRUCTURAL SYSTEM	MATERIAL	GENERAL DESCRIPTION	PROBLEM DESCRIPTION	DANGER	REMARKS	
12b	Elephant Statue				Stone	Stone elephant statue on left side of entrance	Good Condition			
12c	Elephant Statue				Stone	Stone elephant statue on right side of entrance	Good Condition			

12d STATUE



12e STATUE



CODE NO	TYOLOGY	MONUMENT NAME	ESTABLISHED/ RENOVATED	STRUCTURAL SYSTEM	MATERIAL	GENERAL DESCRIPTION	PROBLEM DESCRIPTION	DANGER	REMARKS	
12d	Statue				Stone	Stone statue with metal umbrella	Parts of the statue detached			
12e	Statue				Stone, Brick	Stone statue on brick wall with stone umbrella	Good Condition			

12f PILLAR



12g BULL



12h STATUE



CODE NO	TYOLOGY	MONUMENT NAME	ESTABLISHED/ RENOVATED	STRUCTURAL SYSTEM	MATERIAL	GENERAL DESCRIPTION	PROBLEM DESCRIPTION	DANGER	REMARKS	
12f	Pillar				Stone	Stone pillar with bull on top	Pillar slightly tilted.			
12g	Bull				Stone	Stone bull in front of temple	Cracks at base; Slightly tilted			
12h	Statue				Stone; Brick	Stone statue on elevated brick platform	Good Condition			

13 DASHAIN GHAR



CODE NO	TYOLOGY	MONUMENT NAME	ESTABLISHED/ RENOVATED	STRUCTURAL SYSTEM	MATERIAL	GENERAL DESCRIPTION	PROBLEM DESCRIPTION	DANGER	REMARKS
13	Single Storey temple	Dashain Ghar	19th century	Load Bearing	Brick;Timber	Single storey structure on raised plinth;Roof supported by timber column	Bricks in plinth detached;Roof tiles detached;Walls and columns in good condition		

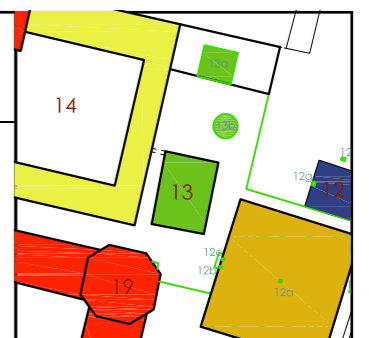

13a



13b WELL



CODE NO	TYOLOGY	MONUMENT NAME	ESTABLISHED/RENOVATED	STRUCTURAL SYSTEM	MATERIAL	GENERAL DESCRIPTION	PROBLEM DESCRIPTION	DANGER	REMARKS
13a	Single-storey temple	Jug Bahadur Well					No visible damages		
13b	Well					No visible damages			

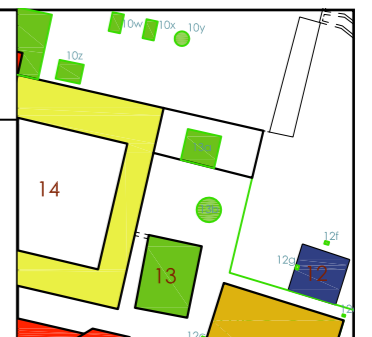

14 MOOL CHOWK



CODE NO	TYOLOGY	MONUMENT NAME	ESTABLISHED/ RENOVATED	STRUCTURAL SYSTEM	MATERIAL	GENERAL DESCRIPTION	PROBLEM DESCRIPTION	DANGER	REMARKS
14	Chwok	Mool Chowk	16th century			Main courtyard of the palace with uniform height on four sides;	slightly damage on roof of surrounding temple		

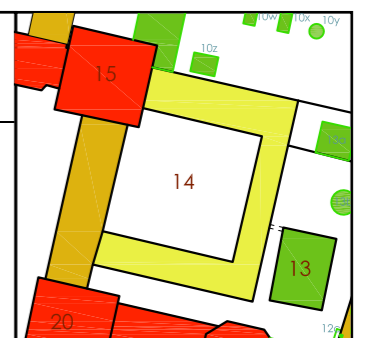

15 PANCHAMUKHI HANUMAN TEMPLE



CODE NO	TYOLOGY	MONUMENT NAME	ESTABLISHED/ RENOVATED	STRUCTURAL SYSTEM	MATERIAL	GENERAL DESCRIPTION	PROBLEM DESCRIPTION	DANGER	REMARKS
15	Multitiered temple	Panchmukhi Hanuman	17th century	Load Bearing	Brick;Timber	Made up of five circular storeys;Temple of five faced hanuman	Extensive external and internal cracks; Top part tilted		

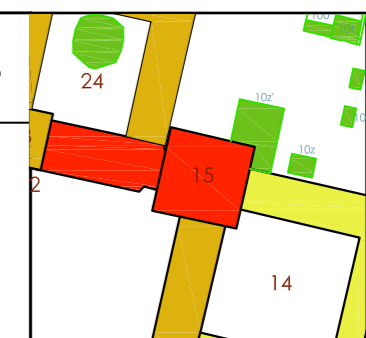

16 NASAL CHOWK



CODE NO	TYOLOGY	MONUMENT NAME	ESTABLISHED/ RENOVATED	STRUCTURAL SYSTEM	MATERIAL	GENERAL DESCRIPTION	PROBLEM DESCRIPTION	DANGER	REMARKS
16	Courtyard	Nasal Chowk	17th century			Structures on northern,western and southern side of the courtyard are 19th century.	South side building collapsed. Bulging of walls in east side;walls unstable and currently supported by struts.		

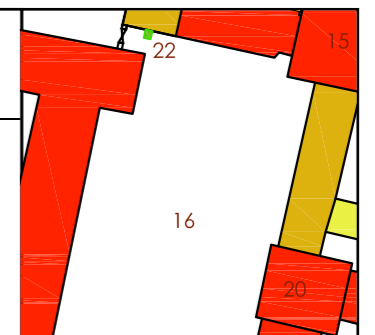

17 BASANTAPUR BHAWAN



CODE NO	TYOLOGY	MONUMENT NAME	ESTABLISHED/ RENOVATED	STRUCTURAL SYSTEM	MATERIAL	GENERAL DESCRIPTION	PROBLEM DESCRIPTION	DANGER	REMARKS
17	Nine Storeyed structure	Basantapur Bhawan	1770	Load Bearing	Brick	Pavilions/tower on the SW corner of Lohanchok	3 floor fallen down, concrete beam introduced, vegetation growth on roof		

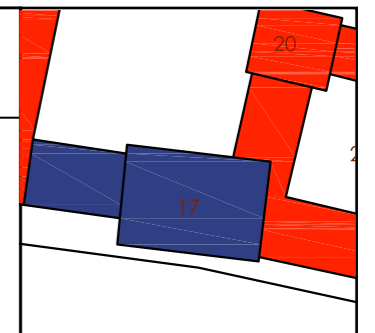

18 LALITPUR BHAWAN



CODE NO	TYOLOGY	MONUMENT NAME	ESTABLISHED/ RENOVATED	STRUCTURAL SYSTEM	MATERIAL	GENERAL DESCRIPTION	PROBLEM DESCRIPTION	DANGER	REMARKS
18	Six Storey Structure	Lalitpur Bhawan	1770	Load Bearing	Brick	Pavilions built on ES corner of Lohan chok, served as watchtowers for the palace	Tilted to north, vegetation growth on roof, vertical crack on wall		



19 BHAKTAPUR BHAWAN



CODE NO	TYOLOGY	MONUMENT NAME	ESTABLISHED/RENOVATED	STRUCTURAL SYSTEM	MATERIAL	GENERAL DESCRIPTION	PROBLEM DESCRIPTION	DANGER	REMARKS	
19	Six Storey Structure	Bhaktapur Bhawan	1770	Load Bearing	Brick	Octagonal timber structure with tiled roof, towers on the NE corner. The façade consists of series of carved windows	Roof has fallen down, dampness on dalin & ceiling			

20 KRITIPUR BHAWAN

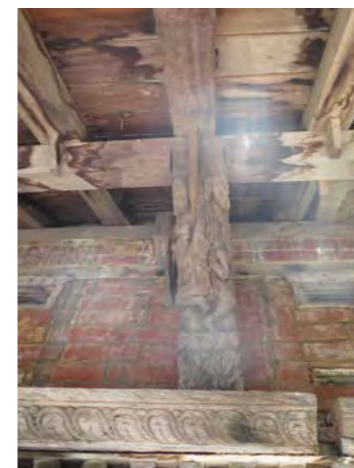
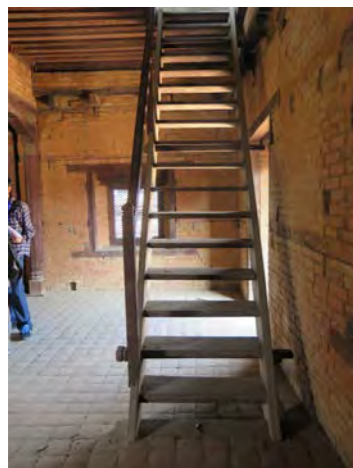
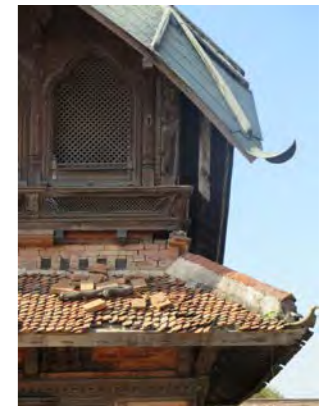

CODE NO	TYOLOGY	MONUMENT NAME	ESTABLISHED/ RENOVATED	STRUCTURAL SYSTEM	MATERIAL	GENERAL DESCRIPTION	PROBLEM DESCRIPTION	DANGER	REMARKS
20	Six Storey Structure	Kirtipur Bhawan	18th Century	Load Bearing	Brick; Timber	Timber structure raised on brick base forming part of the fifth storey. Roof has curvilinear form and covered with metal sheets.	Extensive cracking of walls; Settlement of walls; timber columns cracked and tiles detached.		

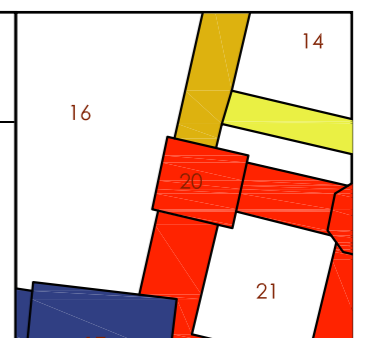

21 LOHAN CHOWK

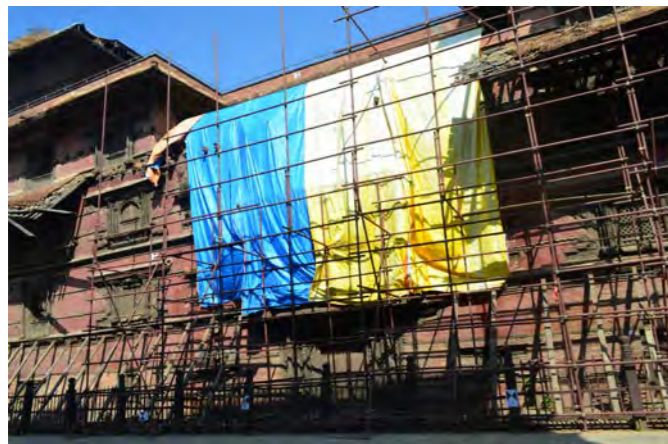



CODE NO	TYOLOGY	MONUMENT NAME	ESTABLISHED/ RENOVATED	STRUCTURAL SYSTEM	MATERIAL	GENERAL DESCRIPTION	PROBLEM DESCRIPTION	DANGER	REMARKS
21	Courtyard	Lohon Chowk	1769	Load Bearing		It is a part of Basantapur palace. It consists of stone pavings. Elaborately decorated by carved pillars and window	Buildings around the courtyard are highly damaged with large wall and floor cracks and broken beams. The overhanging roof has been damaged making the carved windows susceptible to rain and dampness.		Damage assessment of buildings surrounding Lohan chowk.



22 NARSINGH IMAGE

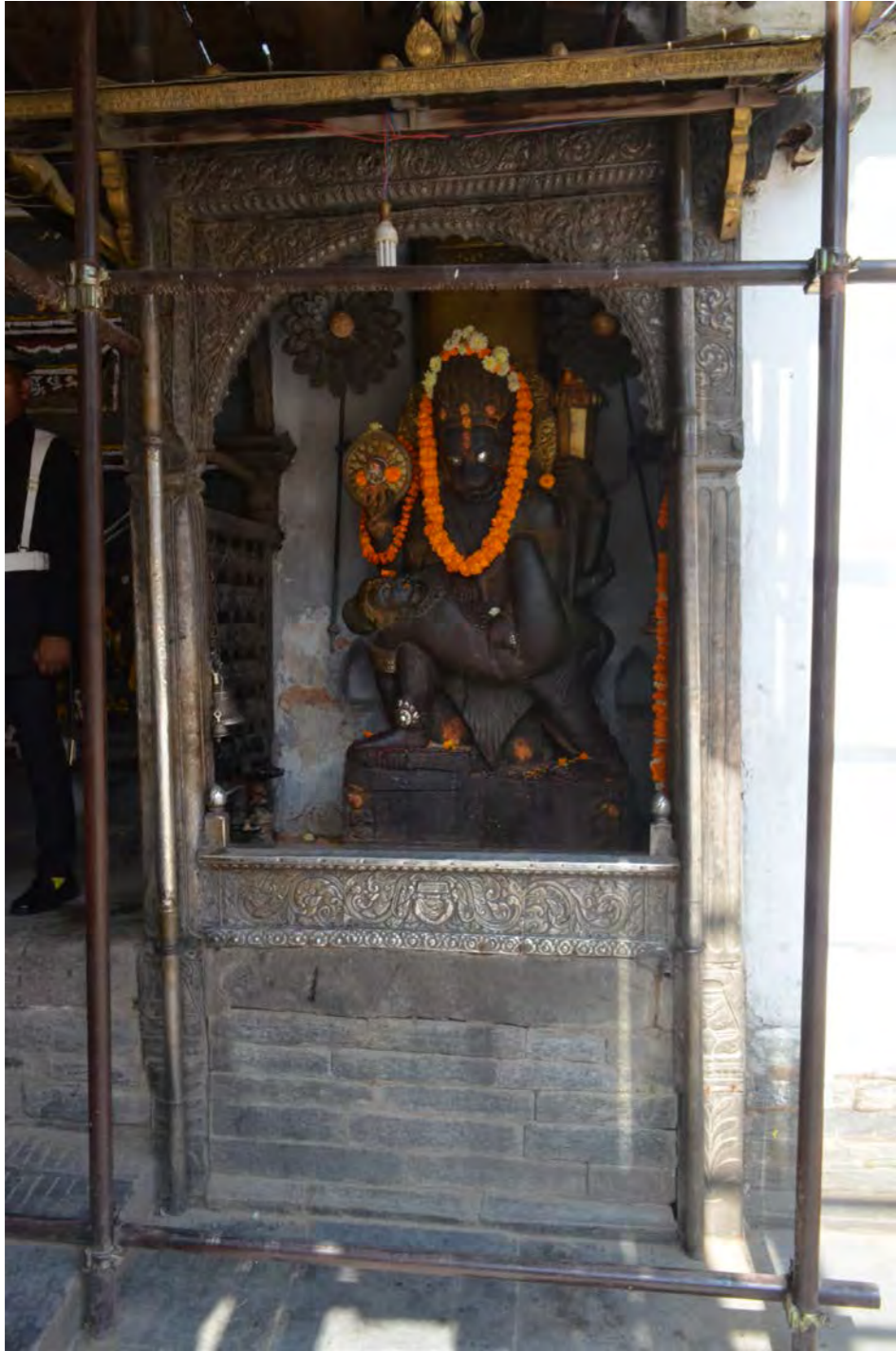

CODE NO	TYOLOGY	MONUMENT NAME	ESTABLISHED/ RENOVATED	STRUCTURAL SYSTEM	MATERIAL	GENERAL DESCRIPTION	PROBLEM DESCRIPTION	DANGER	REMARKS	
22	Stone Sculpture	Narsingh Image	1673			located in corner of Nasal chok, image of Vishnu disemboweling the demon Hiranyakashyapa	No visible damage			

23 AAGAN TEMPLE

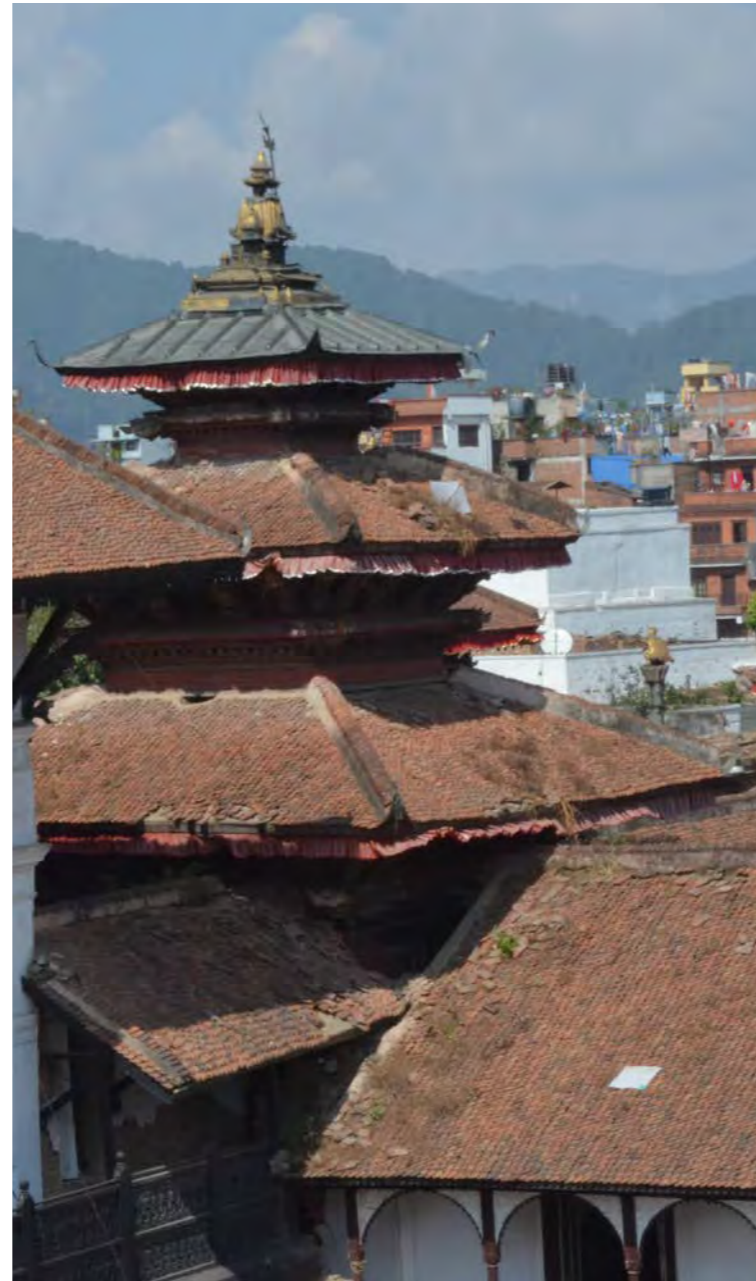

CODE NO	TYOLOGY	MONUMENT NAME	ESTABLISHED/ RENOVATED	STRUCTURAL SYSTEM	MATERIAL	GENERAL DESCRIPTION	PROBLEM DESCRIPTION	DANGER	REMARKS	
23	Three storey temple	Aagan temple	1967			Built on 2nd floor of the old palace, carved figure struts; most of which are shiva, deity of this temple was the family god of malla kings	Vertical crack, tilted, vegetation growth on roof			

24 MOHAN CHOWK



CODE NO	TYOLOGY	MONUMENT NAME	ESTABLISHED/ RENOVATED	STRUCTURAL SYSTEM	MATERIAL	GENERAL DESCRIPTION	PROBLEM DESCRIPTION	DANGER	REMARKS
24	Courtyard	Mohab Chowk	1648			Courtyard used as private residence of Pratap malla. Has some notable examples of sculputres including pieces depicting krishna defeating kaliya serpent.	Walls surrounding the courtyard cracked and bulging		

25 SUNDARI CHOWK



CODE NO	TYOLOGY	MONUMENT NAME	ESTABLISHED/ RENOVATED	STRUCTURAL SYSTEM	MATERIAL	GENERAL DESCRIPTION	PROBLEM DESCRIPTION	DANGER	REMARKS
25	Courtyard	Sundari chok	1649			Located in north of Nasal-chowk, water conduit in the middle, used to lay the dying king, usually closed to visitors	crack on surrounding building, dampness on the wall due to leakage of water from roof, dampness rises		Damage assessment of buildings around the chowk.

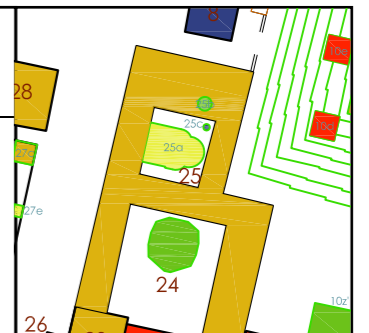

25A SUNDARI DHARA



25b TULSI



25c WELL



CODE NO	TYOLOGY	MONUMENT NAME	ESTABLISHED/ RENOVATED	STRUCTURAL SYSTEM	MATERIAL	GENERAL DESCRIPTION	PROBLEM DESCRIPTION	DANGER	REMARKS
25a	Stone Spout	Sundari dahra		Stone sculpture	Stone	sculpture of krishna staying above Nagaraj just opposite of tap	fungi, algea growth, dampness rises		
25b		Tulsi			Brick	Tulsi with brick base	No visible damage		
25c		well			Brick	Well within the building.	No visible damage		

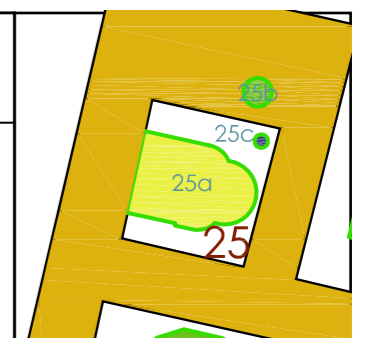

26 HANUMAN IMAGE



CODE NO	TPOLOGY	MONUMENT NAME	ESTABLISHED/ RENOVATED	STRUCTURAL SYSTEM	MATERIAL	GENERAL DESCRIPTION	PROBLEM DESCRIPTION	DANGER	REMARKS	
26	Idol	Hanuman	1672			stone idol of hanuman	No visible damage			

27 JAGANNATH



CODE NO	TYOLOGY	MONUMENT NAME	ESTABLISHED/ RENOVATED	STRUCTURAL SYSTEM	MATERIAL	GENERAL DESCRIPTION	PROBLEM DESCRIPTION	DANGER	REMARKS
27	Two storey temple	Jagannath	Renovated 2006				cracks on upper storey, some stones on plinth missing on west, minor cracks on north plinth		

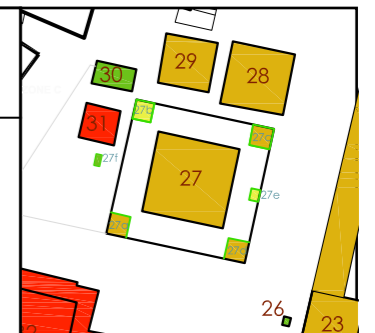

27a, 27b, 27c TWO STOREY TEMPLES

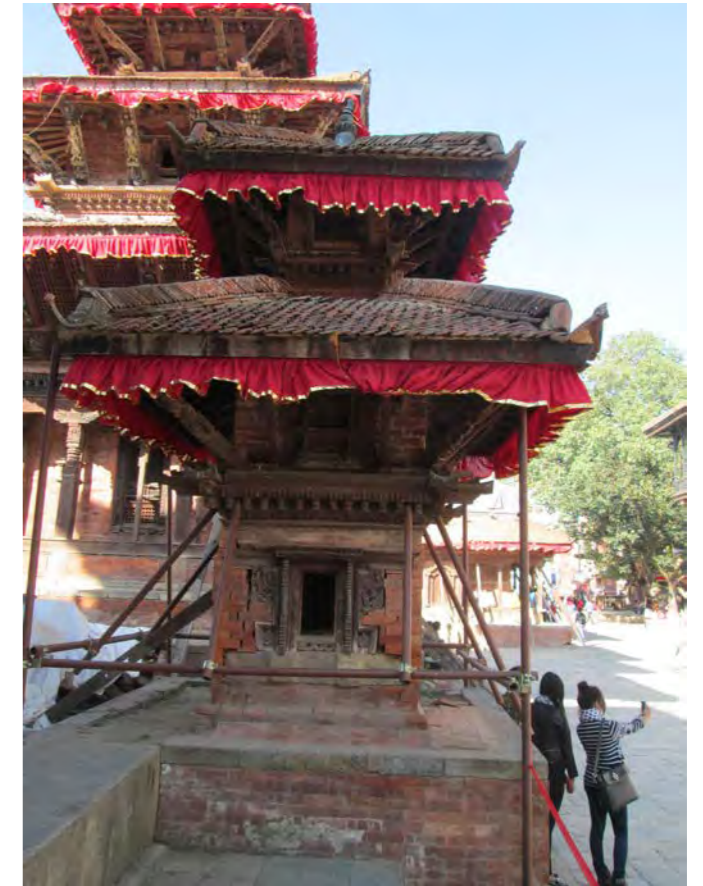

CODE NO	TYOLOGY	MONUMENT NAME	ESTABLISHED/ RENOVATED	STRUCTURAL SYSTEM	MATERIAL	GENERAL DESCRIPTION	PROBLEM DESCRIPTION	DANGER	REMARKS
27a	Two storey temple					No idol inside	tilted to south, bricks dislocation		
27b	Two storey temple					No idol inside	bricks dislocation, minor cracks		
27c	Two storey temple					No idol inside	bricks dislocation		

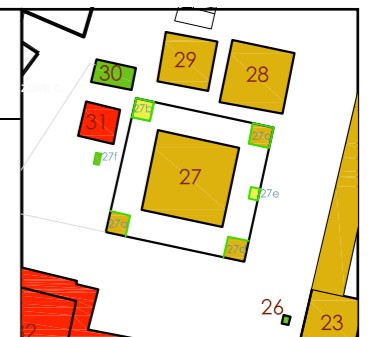

27d TWO STOREY TEMPLE



27e SHIVALINGA



27f STONE POST



CODE NO	TYOLOGY	MONUMENT NAME	ESTABLISHED/ RENOVATED	STRUCTURAL SYSTEM	MATERIAL	GENERAL DESCRIPTION	PROBLEM DESCRIPTION	DANGER	REMARKS
27d	Two storey temple						bricks dislocation, unstable, easetern wall buldging out		
27e	Shiva Linga					shiva linga on plinth of 27a	stone delapated		
27f	Stone post					stone post with capital at top	top part fall down		

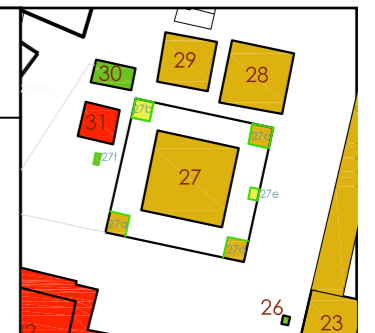

28 GOPINATH



CODE NO	TYOLOGY	MONUMENT NAME	ESTABLISHED/ RENOVATED	STRUCTURAL SYSTEM	MATERIAL	GENERAL DESCRIPTION	PROBLEM DESCRIPTION	DANGER	REMARKS	
28	Three Storey Temple	Gopinath	17th century	Load Bearing	Brick		bricks dislocation, south east corner bulging out			

29 CHATURMUKH LINGASHA

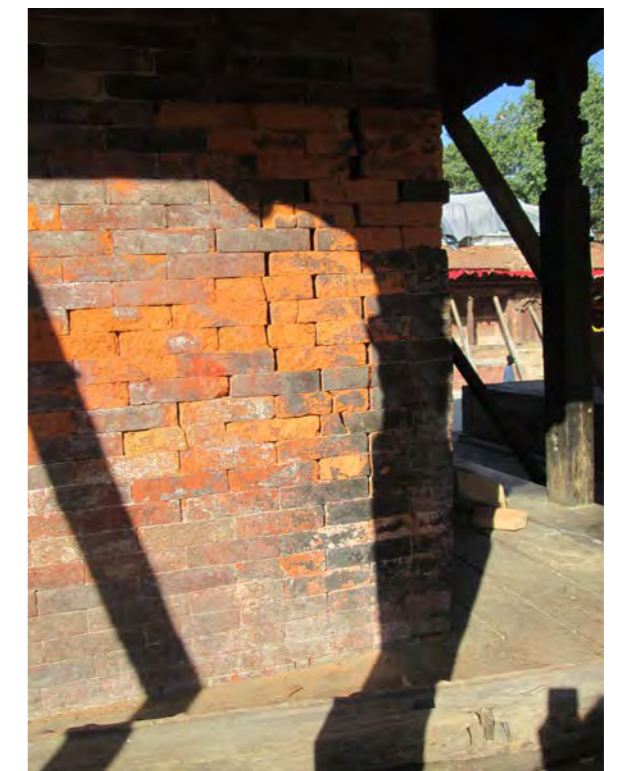

CODE NO	TYOLOGY	MONUMENT NAME	ESTABLISHED/ RENOVATED	STRUCTURAL SYSTEM	MATERIAL	GENERAL DESCRIPTION	PROBLEM DESCRIPTION	DANGER	REMARKS	
29	Two Storey temple	Chaturmukh Lingasha	17th century				south wall brick disintegration, brick deterioration			

30 KAL BHAIRAV



CODE NO	TYOLOGY	MONUMENT NAME	ESTABLISHED/ RENOVATED	STRUCTURAL SYSTEM	MATERIAL	GENERAL DESCRIPTION	PROBLEM DESCRIPTION	DANGER	REMARKS	
30	open shrine	Kal Bhairav	1660				No visible damage			

31 LAXMI NARAYAN

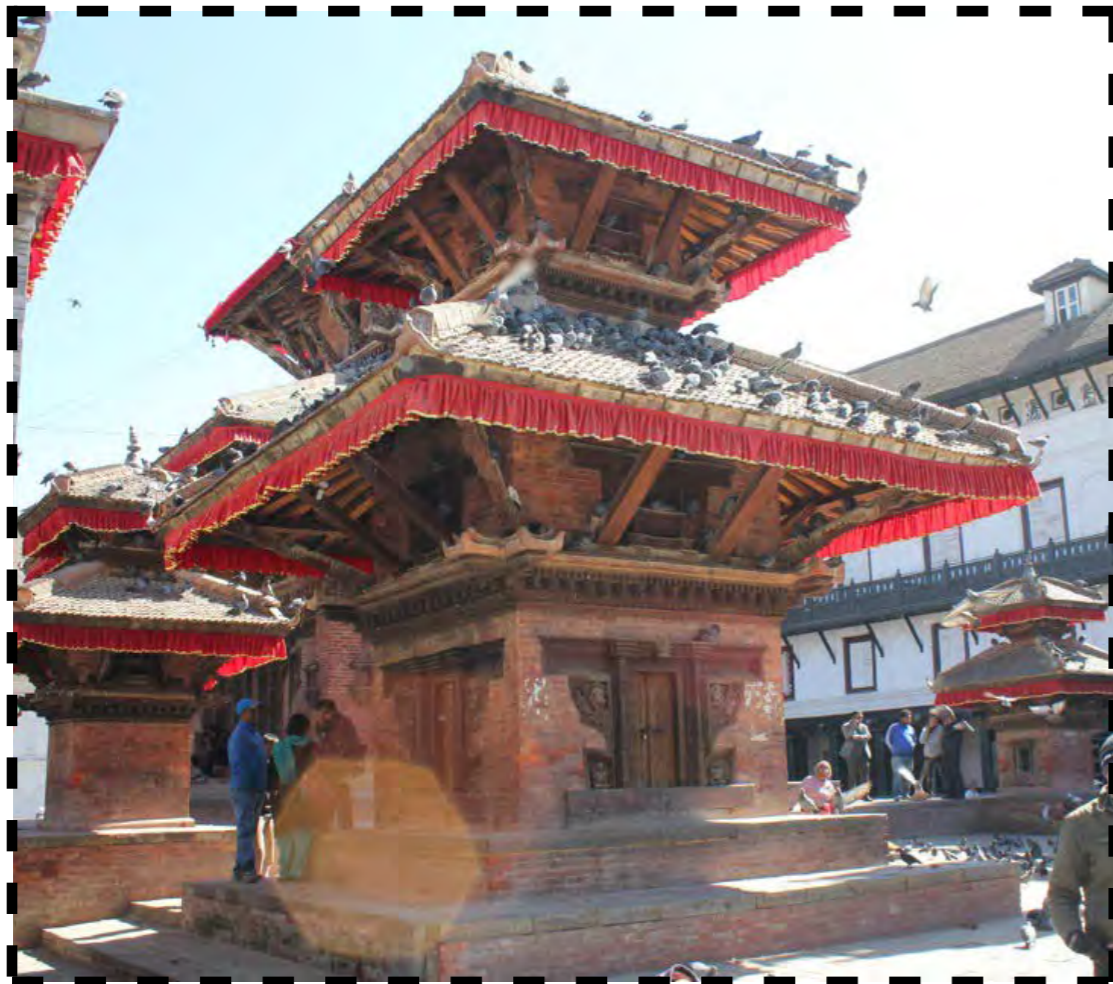

CODE NO	TYOLOGY	MONUMENT NAME	ESTABLISHED/ RENOVATED	STRUCTURAL SYSTEM	MATERIAL	GENERAL DESCRIPTION	PROBLEM DESCRIPTION	DANGER	REMARKS	
31	Two storey temple	Laxmi Narayan	18th Century				All 4 corners separating out			

32 DEGU TALLE TEMPLE



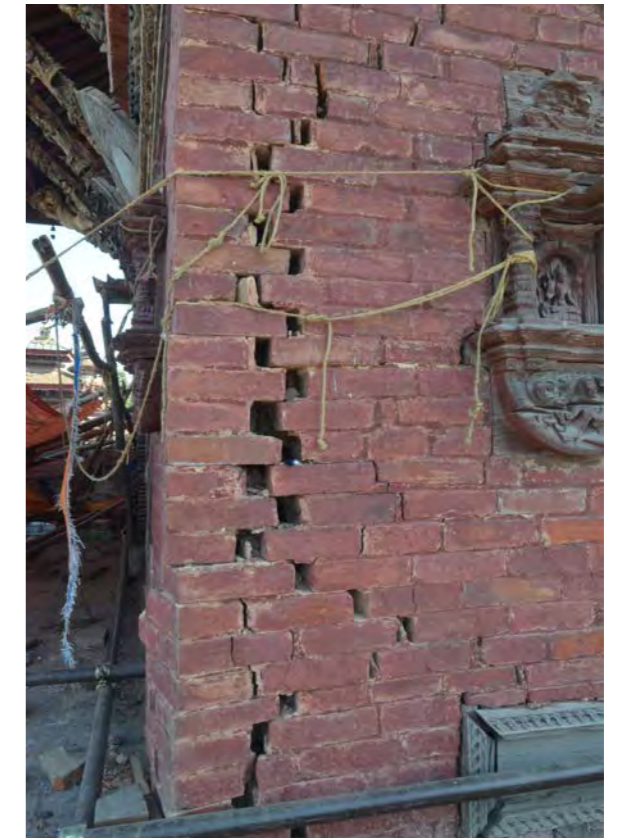
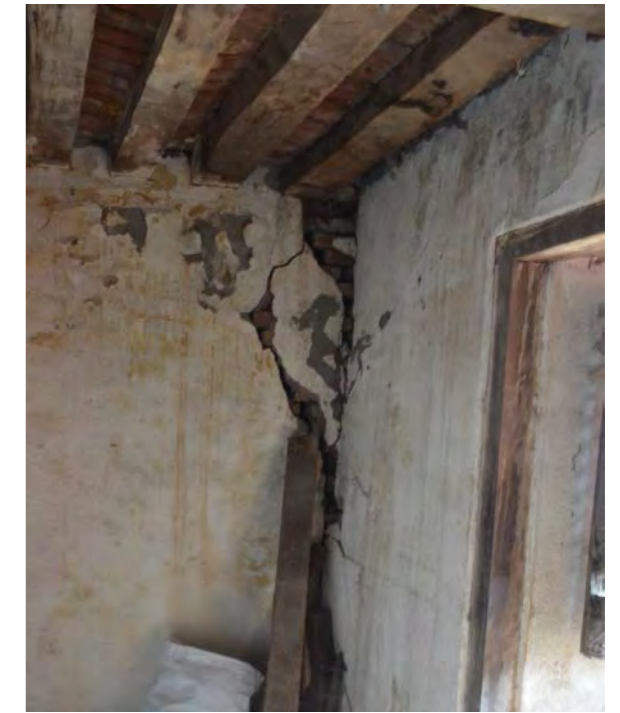

CODE NO	TYOLOGY	MONUMENT NAME	ESTABLISHED/ RENOVATED	STRUCTURAL SYSTEM	MATERIAL	GENERAL DESCRIPTION	PROBLEM DESCRIPTION	DANGER	REMARKS
32	Three Tired Temple	Degu Talle Temple		Load bearing	Brick	Build on 2nd storey of the living quarter. Houses Family divinity of Malla Kings hence assessible form palace only.	WS corner part wall fallen down, major cracks, shoring at south side		

33 SWETA BHAIRAV TEMPLE



CODE NO	TYOLOGY	MONUMENT NAME	ESTABLISHED/ RENOVATED	STRUCTURAL SYSTEM	MATERIAL	GENERAL DESCRIPTION	PROBLEM DESCRIPTION	DANGER	REMARKS
33		Swet Bhairab	1795 by king Raha Bahadur Shah	Load Bearing	Brick;Stucco	The façade almost covered with carved windows. The central large window covers the large face of Bhairav.	Major cracks, tilted and bulging on the north. Bricks in the base falling down. Structure unstable.		



34 CHASIN DEGA TEMPLE



CODE NO	TYOLOGY	MONUMENT NAME	ESTABLISHED/ RENOVATED	STRUCTURAL SYSTEM	MATERIAL	GENERAL DESCRIPTION	PROBLEM DESCRIPTION	DANGER	REMARKS
34	Three storey Temple	Chasin Dega	1649/1947	Load Bearing	Brick	Octagonal temple	Totally collapsed		



34b NAGARA GHAR



CODE NO	TYOLOGY	MONUMENT NAME	ESTABLISHED/ RENOVATED	STRUCTURAL SYSTEM	MATERIAL	GENERAL DESCRIPTION	PROBLEM DESCRIPTION	DANGER	REMARKS	
34b		Nagara Ghar				Pair of huge drums an raised platform	Unstable, tilted to north, major cracks			

34c GANESH



CODE NO	TPOLOGY	MONUMENT NAME	ESTABLISHED/RENOVATED	STRUCTURAL SYSTEM	MATERIAL	GENERAL DESCRIPTION	PROBLEM DESCRIPTION	DANGER	REMARKS
34c	Enclosed shrine	Ganesh					No gajur, roof corner missing		A small site plan map in the bottom right corner of the table. It shows a grid of buildings. A blue octagonal shape is labeled '34'. To its left are two green rectangular shapes labeled 'c7c' and 'c7b'. To its right is a red rectangular shape labeled '34d'. The map also shows some streets and other buildings in the area.

35 SARASWOTI TEMPLE



CODE NO	TYOLOGY	MONUMENT NAME	ESTABLISHED/ RENOVATED	STRUCTURAL SYSTEM	MATERIAL	GENERAL DESCRIPTION	PROBLEM DESCRIPTION	DANGER	REMARKS
35	Single storey Temple	Saraswati	18th century	Load Bearing	Brick		major cracks, tilted to south, bricks dislocation, NE corners plinth part missing, bricks deteriorated by damp		

36 KRISHNA TEMPLE



CODE NO	TPOLOGY	MONUMENT NAME	ESTABLISHED/ RENOVATED	STRUCTURAL SYSTEM	MATERIAL	GENERAL DESCRIPTION	PROBLEM DESCRIPTION	DANGER	REMARKS
36	Three storey Temple	4 armed krishna					wall cracks all over, tilted to SE		

37 TAGA GAN



CODE NO	TYOLOGY	MONUMENT NAME	ESTABLISHED/ RENOVATED	STRUCTURAL SYSTEM	MATERIAL	GENERAL DESCRIPTION	PROBLEM DESCRIPTION	DANGER	REMARKS
37		Taga Gan	1779				Base may be unstable		

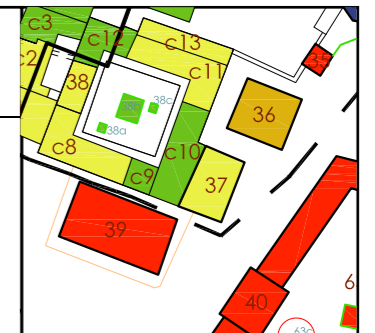

38 LYAKU BAHU



CODE NO	TYOLOGY	MONUMENT NAME	ESTABLISHED/ RENOVATED	STRUCTURAL SYSTEM	MATERIAL	GENERAL DESCRIPTION	PROBLEM DESCRIPTION	DANGER	REMARKS	
38	Bahi	Lyaku Bahi		Load Bearing	Brick	G+2	Minor cracks on outer wall			

38a



38b



38c



CODE NO	TYOLOGY	MONUMENT NAME	ESTABLISHED/ RENOVATED	STRUCTURAL SYSTEM	MATERIAL	GENERAL DESCRIPTION	PROBLEM DESCRIPTION	DANGER	REMARKS
38a	Open Shrine					shrine under tree	No visible damage		
38b	Chaitya					covered by metal roof	No visible damage		
38c	Chaitya						No visible damage		

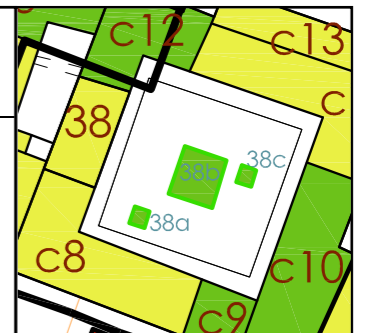

39 NAVA JOGINI HOUSE (SHIVA PARBATI TEMPLE)

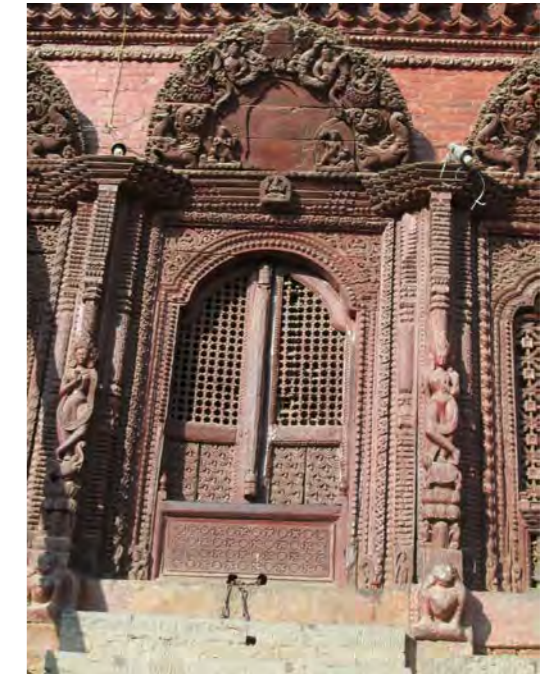
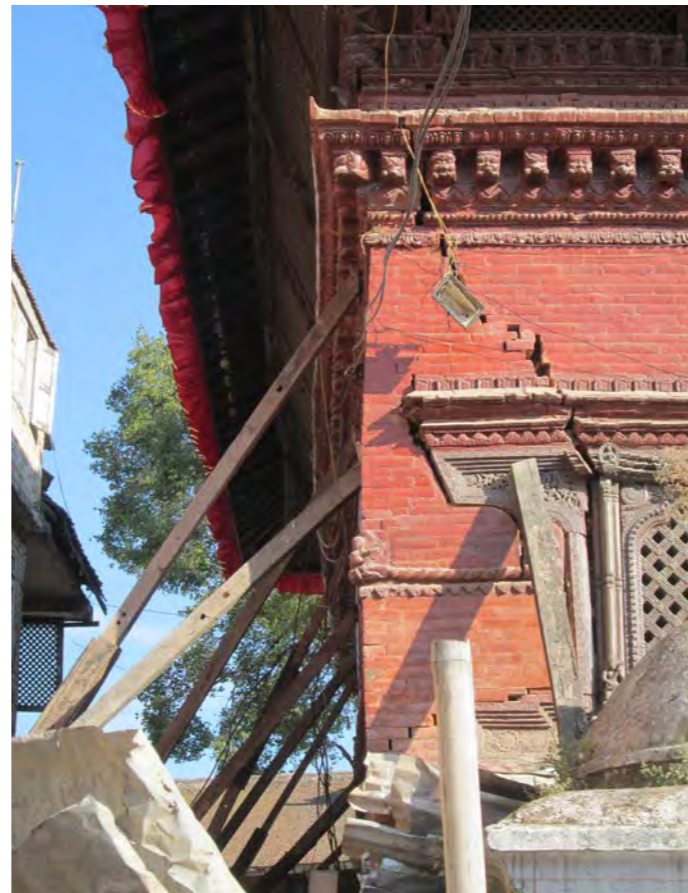
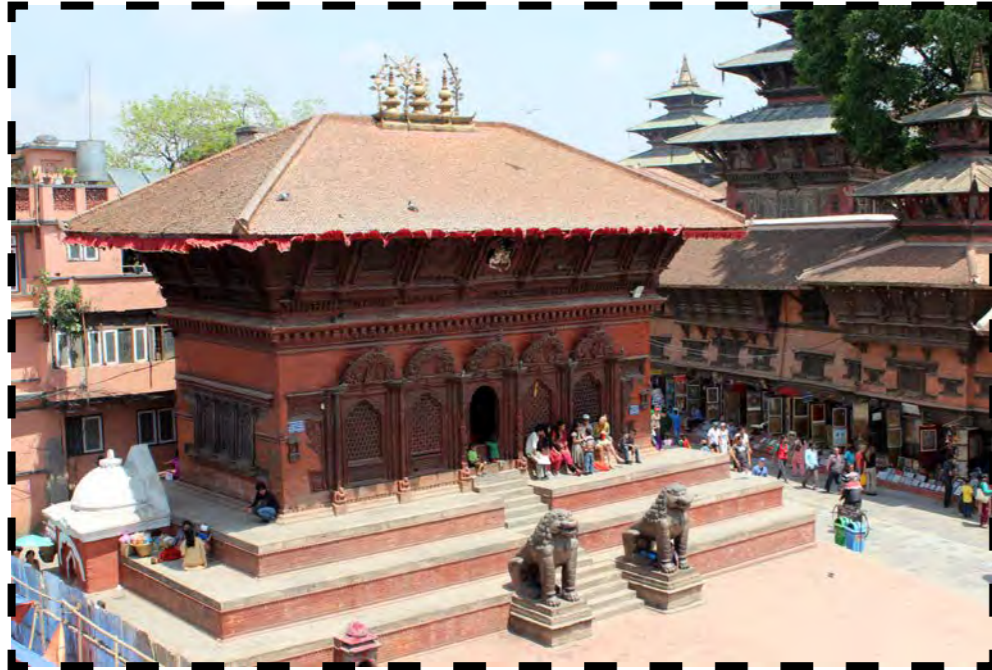

CODE NO	TYOLOGY	MONUMENT NAME	ESTABLISHED/ RENOVATED	STRUCTURAL SYSTEM	MATERIAL	GENERAL DESCRIPTION	PROBLEM DESCRIPTION	DANGER	REMARKS
39	Single storey temple	Nava Jogini		Load Bearing	Brick	Rectangular temple on stepped brick platform. Figures of Shiva and Parvati looking down the street	Tilted to north, major cracks in walls		

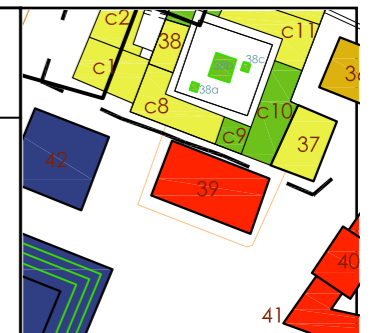

40 BHAGWATI TEMPLE



CODE NO	TYOLOGY	MONUMENT NAME	ESTABLISHED/ RENOVATED	STRUCTURAL SYSTEM	MATERIAL	GENERAL DESCRIPTION	PROBLEM DESCRIPTION	DANGER	REMARKS
40	Two Storey Temple	Bhagvati		Load Bearing	Brick	Bhagvati shrine built over the palace. Wooden struts and latted balcony are carved.	Bulging of walls		



41 KUMARI TEMPLE

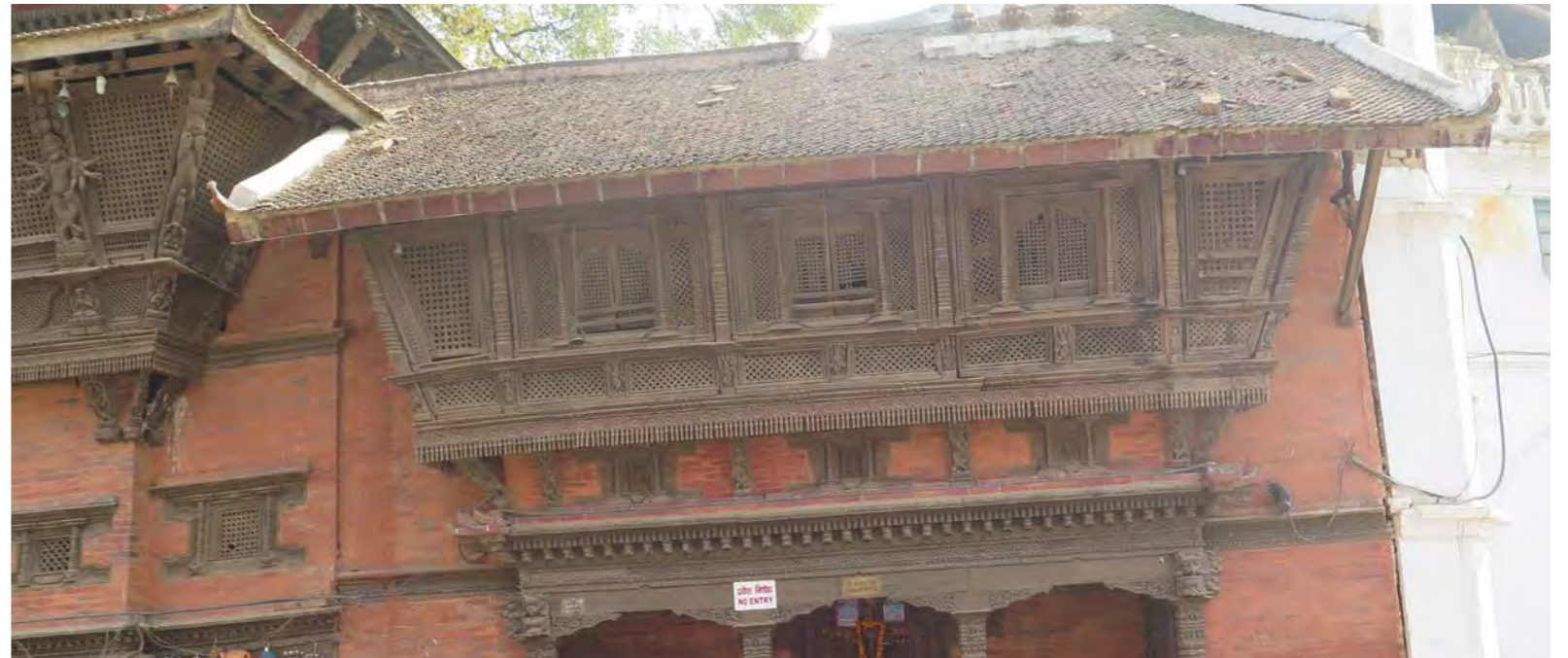

CODE NO	TYOLOGY	MONUMENT NAME	ESTABLISHED/ RENOVATED	STRUCTURAL SYSTEM	MATERIAL	GENERAL DESCRIPTION	PROBLEM DESCRIPTION	DANGER	REMARKS
41	Two Storey Temple	Kumari	1741	Load Bearing	Brick	Small shrine made in form of normal storeyed temple	Bulging of walls		



42 NARAYAN TEMPLE



CODE NO	TYOLOGY	MONUMENT NAME	ESTABLISHED/ RENOVATED	STRUCTURAL SYSTEM	MATERIAL	GENERAL DESCRIPTION	PROBLEM DESCRIPTION	DANGER	REMARKS
42	Three storey temple	Narayan				Was being renovated during Eq	Totally collapsed		

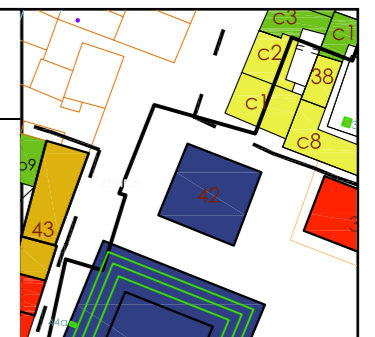

43 MARU JOSHI AAGAN CHEIN



CODE NO	TYOLOGY	MONUMENT NAME	ESTABLISHED/ RENOVATED	STRUCTURAL SYSTEM	MATERIAL	GENERAL DESCRIPTION	PROBLEM DESCRIPTION	DANGER	REMARKS
43	Three storey temple	Maru Joshi Aagan chein					eastern wall bulging		

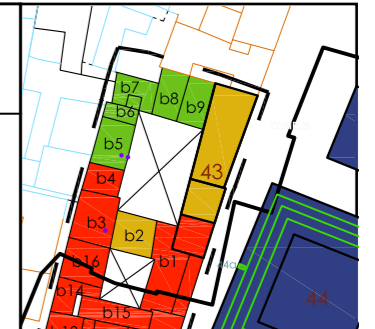

44 NARAYAN TEMPLE



CODE NO	TYOLOGY	MONUMENT NAME	ESTABLISHED/ RENOVATED	STRUCTURAL SYSTEM	MATERIAL	GENERAL DESCRIPTION	PROBLEM DESCRIPTION	DANGER	REMARKS
44		Maju Dega	1692	Load Bearing	Brick; Timber	Temple on top of nine storied brick base; Carved wooden doors and windows;	Totally collapsed; Corners of plinth detached		

44a BULL



CODE NO	TYOLOGY	MONUMENT NAME	ESTABLISHED/ RENOVATED	STRUCTURAL SYSTEM	MATERIAL	GENERAL DESCRIPTION	PROBLEM DESCRIPTION	DANGER	REMARKS
44a		Bull			Stone	Stone bull facing temple on raised plinth	Slightly tilted and settled		

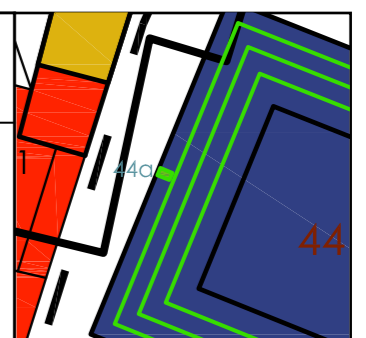

45 GARUD NARAYAN TEMPLE

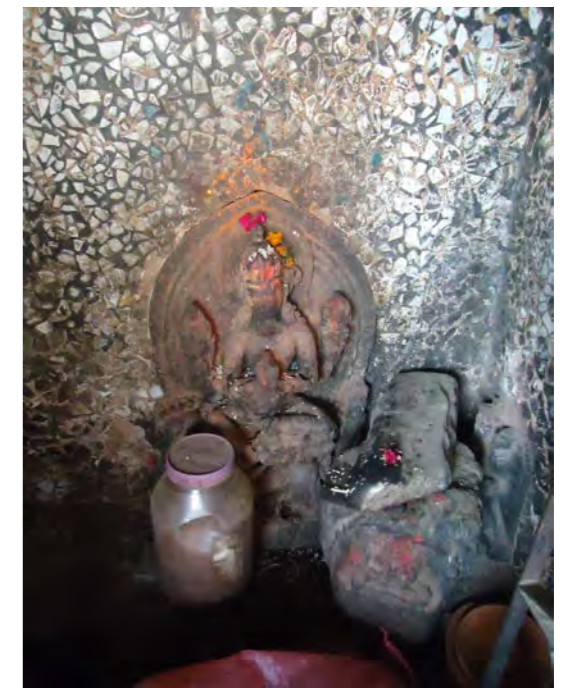

CODE NO	TYOLOGY	MONUMENT NAME	ESTABLISHED/ RENOVATED	STRUCTURAL SYSTEM	MATERIAL	GENERAL DESCRIPTION	PROBLEM DESCRIPTION	DANGER	REMARKS
45	Two storey temple	Garuda Narayan Temple	16 Century	load Bearing	brick;Timber	Tiles on roof. Hanuman sculpture on back face	Extensive cracks on top floor and Bulging of walls		



45a STUPA



45b WATER TANK



CODE NO	TYOLOGY	MONUMENT NAME	ESTABLISHED/ RENOVATED	STRUCTURAL SYSTEM	MATERIAL	GENERAL DESCRIPTION	PROBLEM DESCRIPTION	DANGER	REMARKS
45a	Stupa					Stupa cemented and only top part visible	No visible damage		
45b	Water Tank				Stone	Stone water tank attached to temple not in use	highly dilapadated and about to collapse		



46 ASHOK BINAYAK



CODE NO	TYOLOGY	MONUMENT NAME	ESTABLISHED/ RENOVATED	STRUCTURAL SYSTEM	MATERIAL	GENERAL DESCRIPTION	PROBLEM DESCRIPTION	DANGER	REMARKS
46	Single-Storey Temple	Ashok Binayak		Load Bearing	Brick;Metal	Metal cladding on front face;Brass roof;temple wovrshipped by hindu and budhhists both	No visible damage		

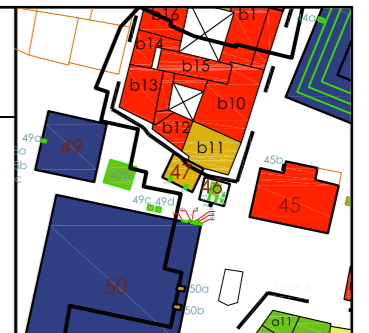

46a,b

46c,d

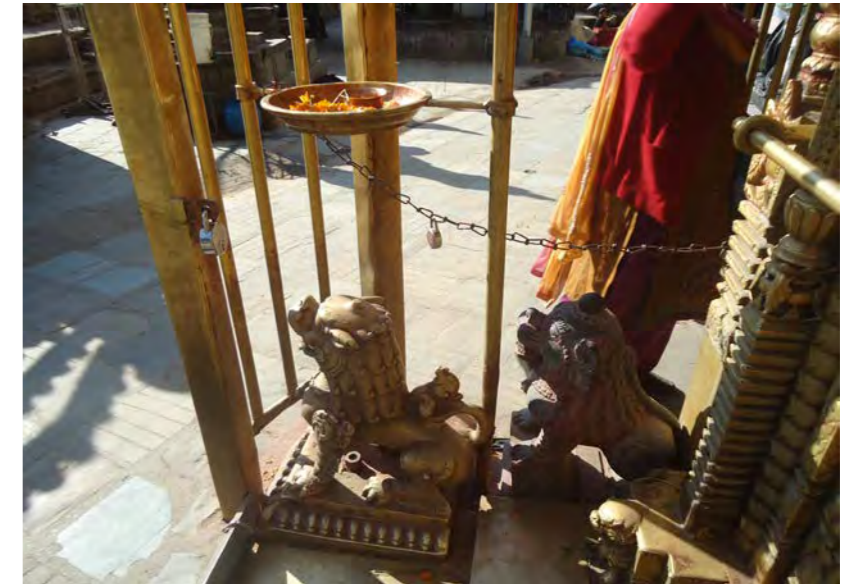

CODE NO	TYOLOGY	MONUMENT NAME	ESTABLISHED/ RENOVATED	STRUCTURAL SYSTEM	MATERIAL	GENERAL DESCRIPTION	PROBLEM DESCRIPTION	DANGER	REMARKS
46a	Guard lion				Stone	Guard lion on right side	No visible damage		
46b	Guard lion				Stone	Guard lion on left side	No visible damage		
46c	Guard lion				Metal	Guard lion on right side	No visible damage		
46d	Guard lion				Metal	Guard lion on left side	No visible damage		

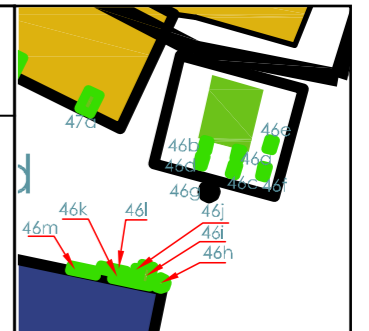

46e

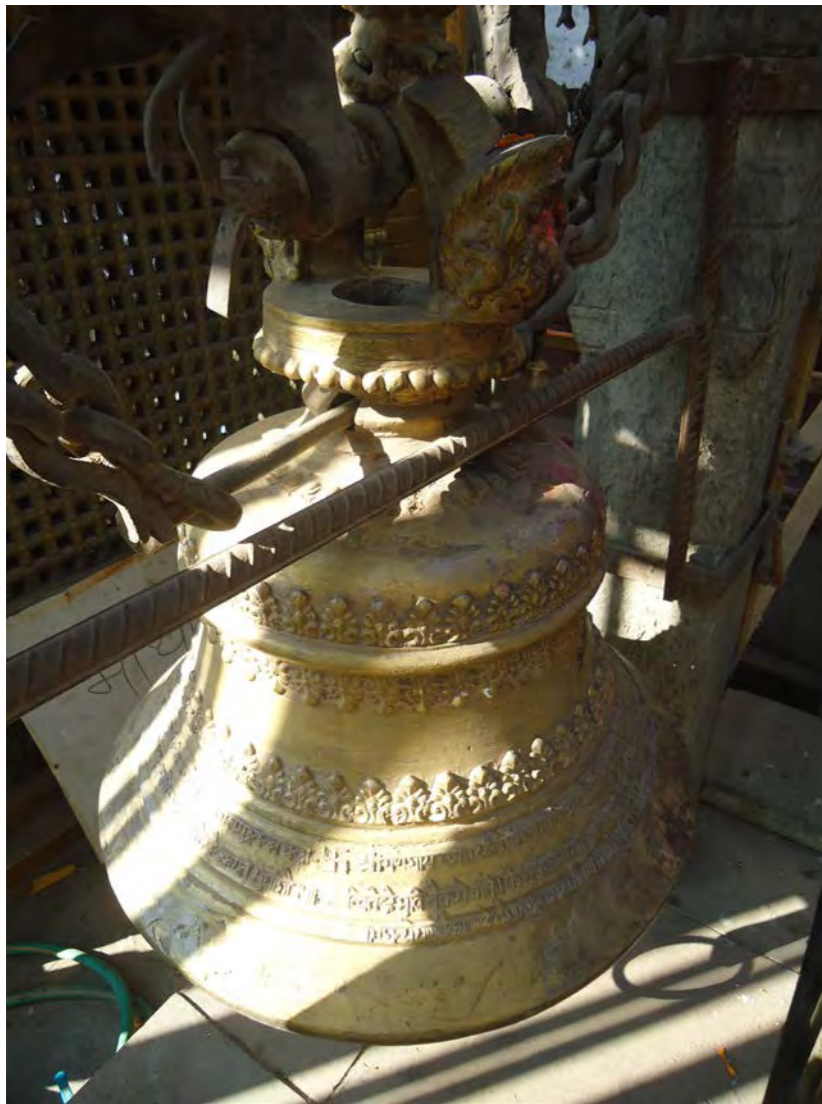

46f



46g



CODE NO	TYOLOGY	MONUMENT NAME	ESTABLISHED/ RENOVATED	STRUCTURAL SYSTEM	MATERIAL	GENERAL DESCRIPTION	PROBLEM DESCRIPTION	DANGER	REMARKS
46e	Bell				Stone;metal	Metal bell on stone frame	No visible damage		
46f	Oil Lamp				Metal	Metal lamp infront of temple	No visible damage		
46g	Mandala				Metal	Metal mandala	No visible damage		

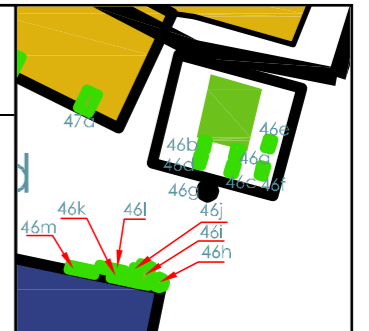

46h



46i

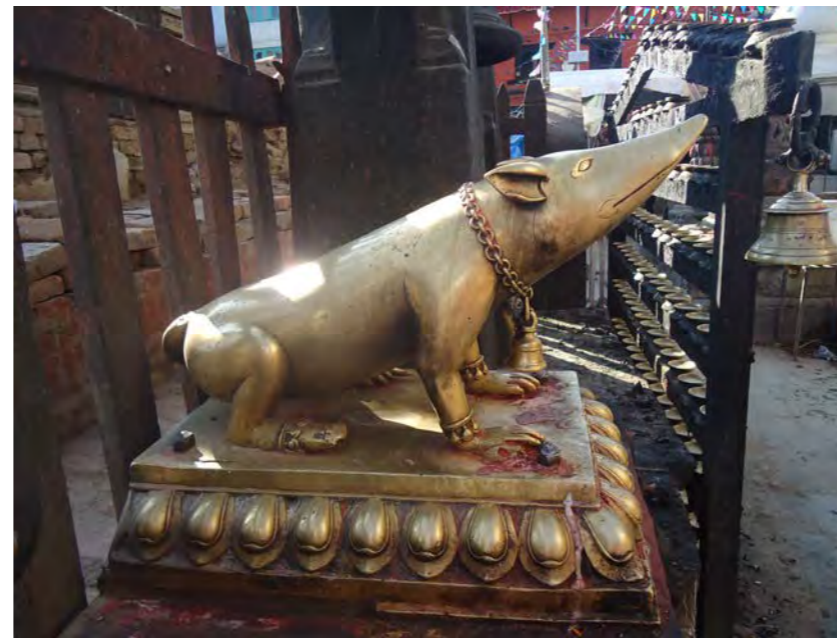

46j



CODE NO	TYOLOGY	MONUMENT NAME	ESTABLISHED/ RENOVATED	STRUCTURAL SYSTEM	MATERIAL	GENERAL DESCRIPTION	PROBLEM DESCRIPTION	DANGER	REMARKS
46h	Bell				Metal	Metal bell in front of temple	No visible damage		
46i	Mouse				Metal	Metal mouse statue	No visible damage		
46j	Mouse				Stone	Stone mouse statue	No visible damage		

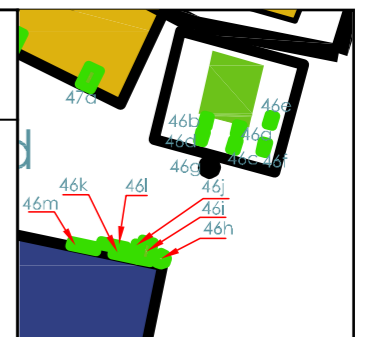

46k



46l



46m



CODE NO	TYOLOGY	MONUMENT NAME	ESTABLISHED/ RENOVATED	STRUCTURAL SYSTEM	MATERIAL	GENERAL DESCRIPTION	PROBLEM DESCRIPTION	DANGER	REMARKS
46k	Bell				Stone	Metal bell in stone and wood frame	No visible damage		
46l	Lamp				Timber	Lamps on wooden frame	No visible damage		
46m	Inscription				Stone	Stone Inscription	No visible damage		

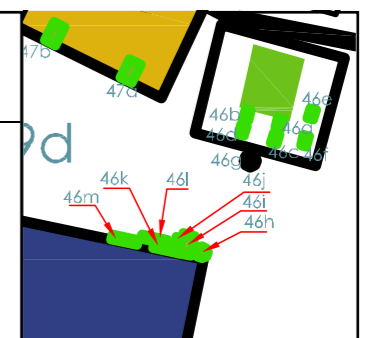

47 DURGA TEMPLE

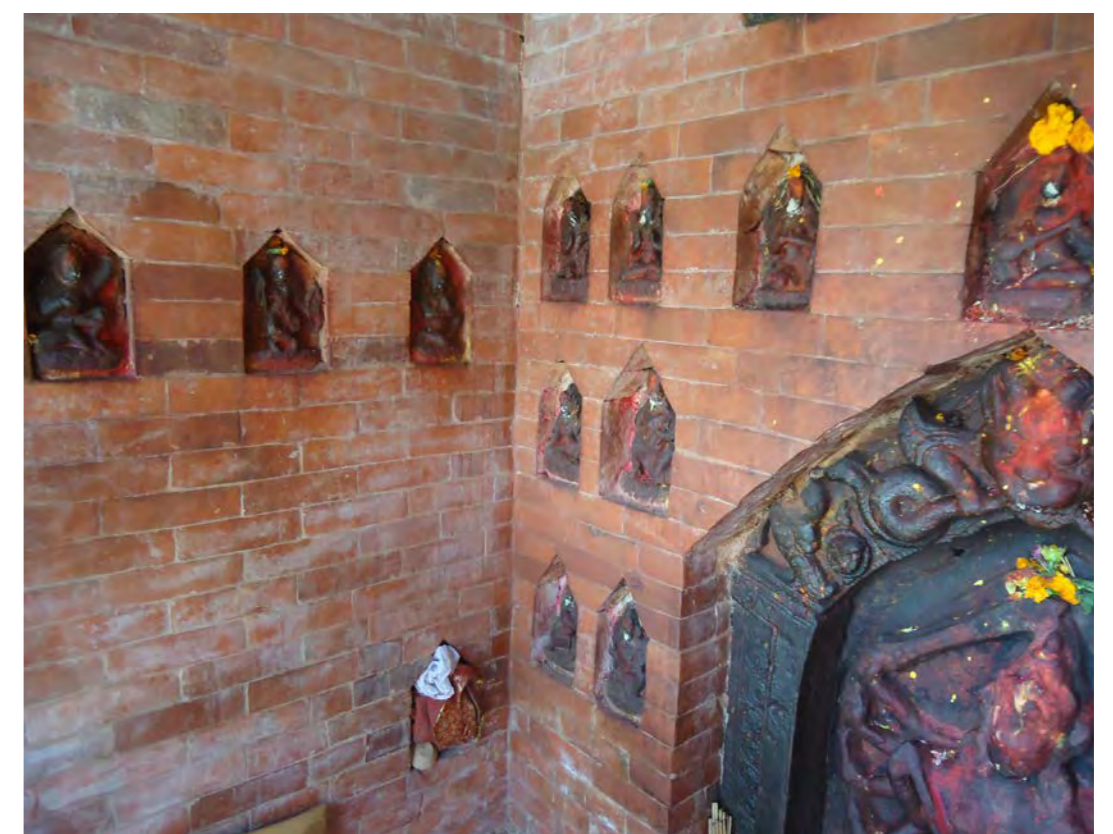

CODE NO	TYOLOGY	MONUMENT NAME	ESTABLISHED/ RENOVATED	STRUCTURAL SYSTEM	MATERIAL	GENERAL DESCRIPTION	PROBLEM DESCRIPTION	DANGER	REMARKS
47	Two-Storey Temple	Durga Temple		Load Bearing	Brick; Timber	Durga Sculpture on slightly raised platform; Open type structure supported by pillars on four sides	Roof tiles missing and minor cracks on walls		



47a



47b



CODE NO	TYOLOGY	MONUMENT NAME	ESTABLISHED/ RENOVATED	STRUCTURAL SYSTEM	MATERIAL	GENERAL DESCRIPTION	PROBLEM DESCRIPTION	DANGER	REMARKS
47a	Guard lion				Stone	Guard lion on right side of entrance	Some parts detached		
47b	Guard lion				Stone	Guard lion on left side of entrance	No visible damage		

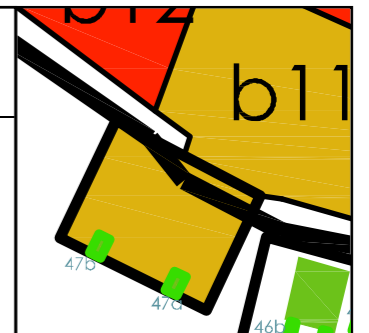

48 AGON DYO

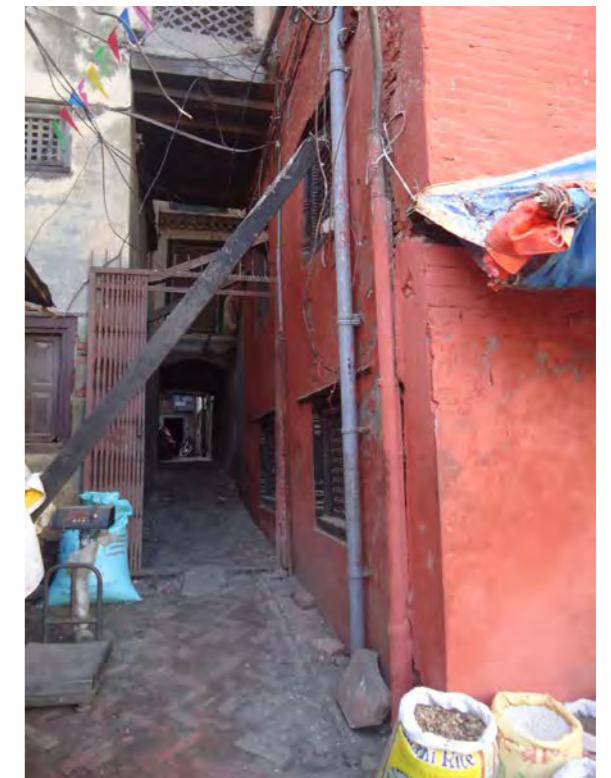
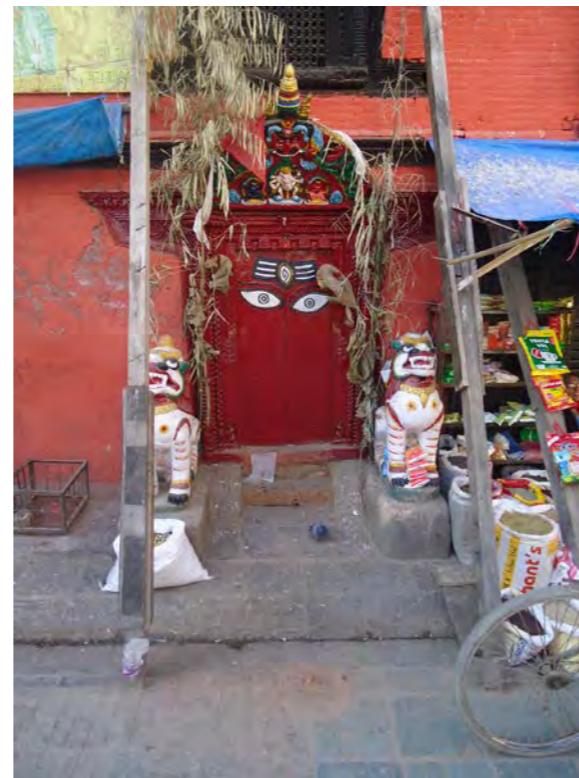

CODE NO	TYOLOGY	MONUMENT NAME	ESTABLISHED/ RENOVATED	STRUCTURAL SYSTEM	MATERIAL	GENERAL DESCRIPTION	PROBLEM DESCRIPTION	DANGER	REMARKS	
48	Dyo chen	Agan Dyo-Agam House	19th century	Load Bearing	Brick;Timber	Three storied with carved wooden dorway guarded by lions;Carved struts with tiled roof	Moderate cracking and bulging of walls.			

48a,b



48c



CODE NO	TPOLOGY	MONUMENT NAME	ESTABLISHED/ RENOVATED	STRUCTURAL SYSTEM	MATERIAL	GENERAL DESCRIPTION	PROBLEM DESCRIPTION	DANGER	REMARKS
48a	Guard lion				Stone	Left guard lion in front of entrance	No visible damage		
48b	Guard lion				Stone	Left guard lion in front of entrance	No visible damage		
48c	Bhairab				Stone	Small enclosed sculpture	No visible damage		

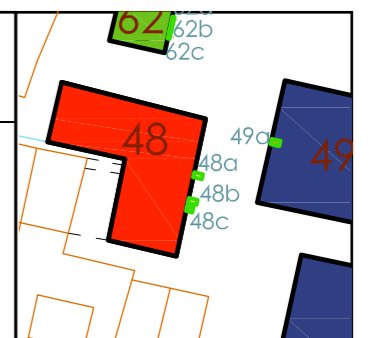

49 SHIVALINGA TEMPLE



CODE NO	TYOLOGY	MONUMENT NAME	ESTABLISHED/ RENOVATED	STRUCTURAL SYSTEM	MATERIAL	GENERAL DESCRIPTION	PROBLEM DESCRIPTION	DANGER	REMARKS	
49	Two Storey Temple	Shiva linga Temple		Load Bearing	Brick;Timber	Shiva linga on raised plinth	Totally collapsed;Extensive cracking on plinth			

49a



49b



CODE NO	TYOLOGY	MONUMENT NAME	ESTABLISHED/ RENOVATED	STRUCTURAL SYSTEM	MATERIAL	GENERAL DESCRIPTION	PROBLEM DESCRIPTION	DANGER	REMARKS
49a	Bull				Stone		Moderate cracks and vegetation growth		
49b	Closed Shrine				Brick	Closed shrine with ganesh sculpture inside on raised platform	No visible damage		

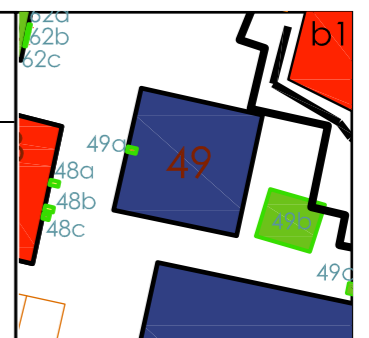

49c



49d



CODE NO	TYOLOGY	MONUMENT NAME	ESTABLISHED/ RENOVATED	STRUCTURAL SYSTEM	MATERIAL	GENERAL DESCRIPTION	PROBLEM DESCRIPTION	DANGER	REMARKS
49c	Chaitya				Stone	Stone chaitya on raised platform with Buddha on four side	Minor cracks on walls		
49d	Chaitya				Stone	"	Minor cracks on base and vegetation growth.		

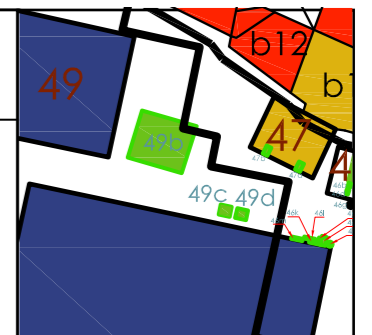

50 KASTHAMANDAP



CODE NO	TYOLOGY	MONUMENT NAME	ESTABLISHED/ RENOVATED	STRUCTURAL SYSTEM	MATERIAL	GENERAL DESCRIPTION	PROBLEM DESCRIPTION	DANGER	REMARKS
50	Three storey temple	Kasthamandap	1620	Load Bearing	Brick;Timber	Located in the center of Maru;Three storied structure with open ground floor	Totally Collapsed		



50a



50b



50c



CODE NO	TYOLOGY	MONUMENT NAME	ESTABLISHED/ RENOVATED	STRUCTURAL SYSTEM	MATERIAL	GENERAL DESCRIPTION	PROBLEM DESCRIPTION	DANGER	REMARKS
50a	Guard lion				Stone	Guard lion on right side of kaasthamandap	Face of the lion detached		
50b	Guard lion				Stone	"	Supports missing		
50c	Platform				Stone;brick	Stone platform onbrick base and slightly raised	Vegetation Growth		



51 MAHADEV TEMPLE



51a



CODE NO	TYOLOGY	MONUMENT NAME	ESTABLISHED/ RENOVATED	STRUCTURAL SYSTEM	MATERIAL	GENERAL DESCRIPTION	PROBLEM DESCRIPTION	DANGER	REMARKS
51	Shikara	Madhev temple	1673	Load Bearing	Brick;Timber	On a slightly raised platform from road;Outer façade recently renovated	No visible damage		
51a	Open shrine	Bishnu Sculoture			Stone		Slightly delapadated and vegetation growth		



51b



51c

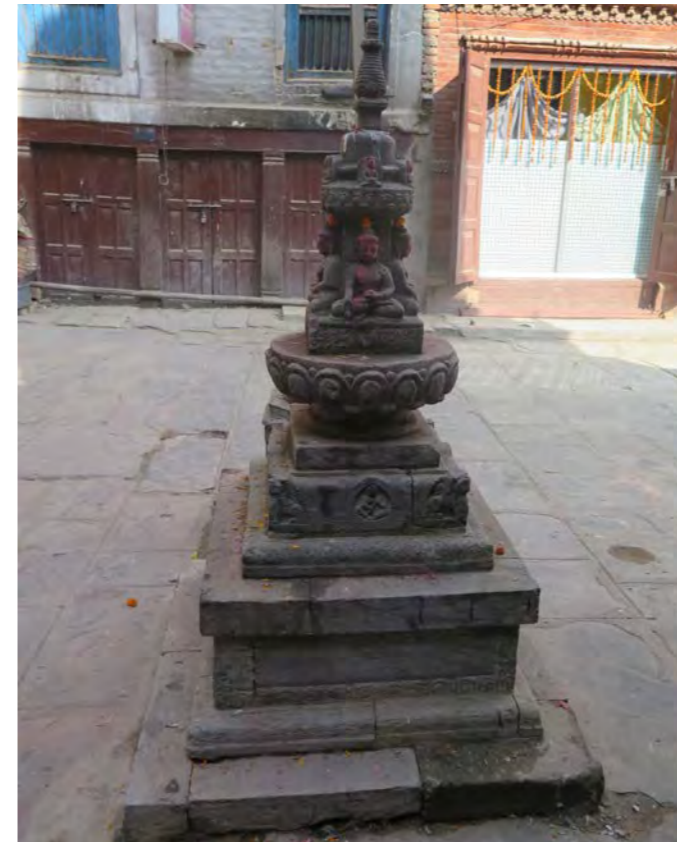
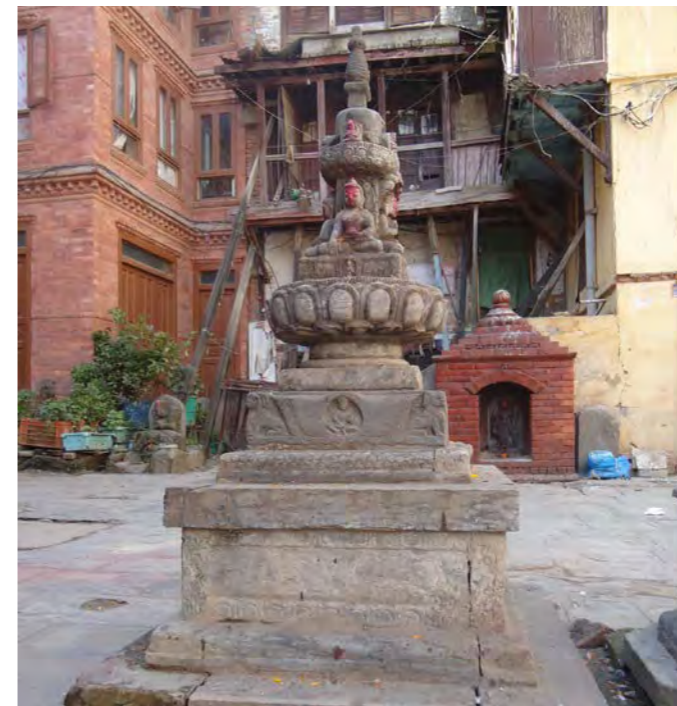

CODE NO	TYOLOGY	MONUMENT NAME	ESTABLISHED/ RENOVATED	STRUCTURAL SYSTEM	MATERIAL	GENERAL DESCRIPTION	PROBLEM DESCRIPTION	DANGER	REMARKS
51b	Chaitya				Stone		Cracks a base;slightly settled;vegetation growth		
51c	Dharmadhatu				Stone	Octagonal in plan with inscription on top, images of various gods on sides	No visible damage		

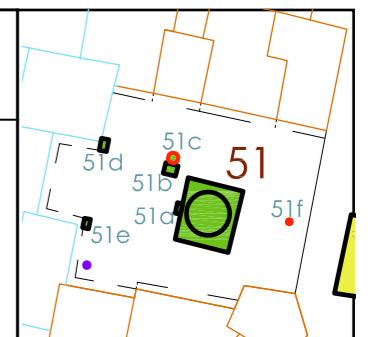

51d



51e



CODE NO	TYOLOGY	MONUMENT NAME	ESTABLISHED/ RENOVATED	STRUCTURAL SYSTEM	MATERIAL	GENERAL DESCRIPTION	PROBLEM DESCRIPTION	DANGER	REMARKS	
51d	Closed Shrine		1118 Nepal Sambat		Brick; Stone	Laxmi goddess with inscription on side	Vegetation growth, cracks on top			
51e	Open Shrine				Stone		Good condition			

52 SILYAN SATTAL



CODE NO	TYOLOGY	MONUMENT NAME	ESTABLISHED/ RENOVATED	STRUCTURAL SYSTEM	MATERIAL	GENERAL DESCRIPTION	PROBLEM DESCRIPTION	DANGER	REMARKS
52		Silyan Sattal		Load Bearing	Brick; Timber	Being renovated by Guthi Sanstha before earthquake	Suffered minor cracks after earthquake		

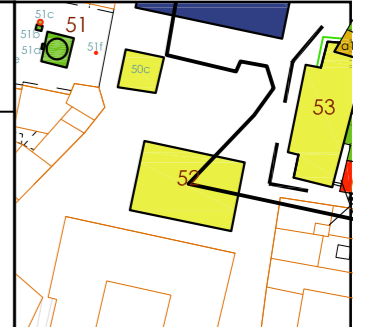

53 DHANSA TEMPLE

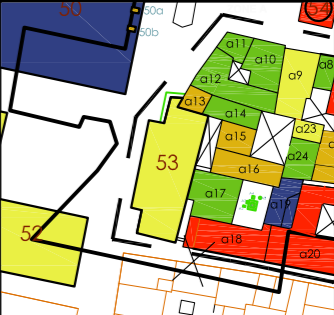

CODE NO	TYOLOGY	MONUMENT NAME	ESTABLISHED/ RENOVATED	STRUCTURAL SYSTEM	MATERIAL	GENERAL DESCRIPTION	PROBLEM DESCRIPTION	DANGER	REMARKS	
53	Three-storied temple	Dhansa Temple	1673	Load Bearing	Brick; Timber	Rectangular in plan; Multi storied pagoda style temple with timber roof and struts; erendha on top floor	Minor cracks on walls; cracks on timber columns			

54 BIMALESHWOR MAHADEV

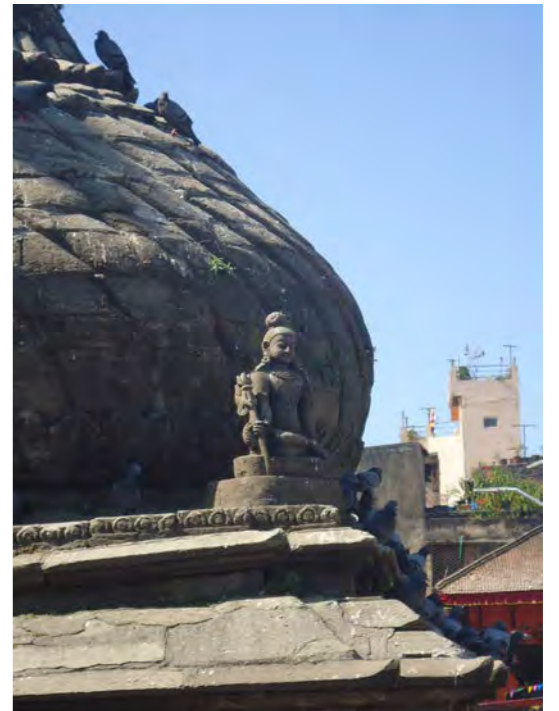
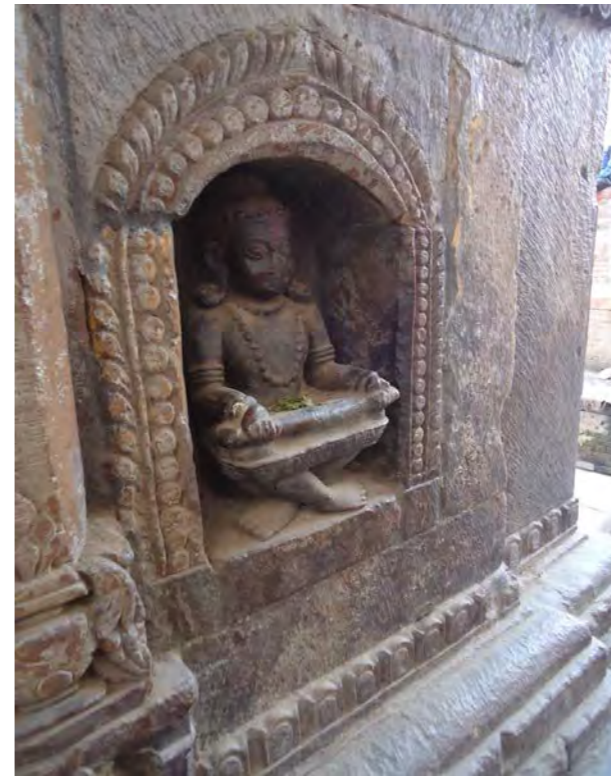
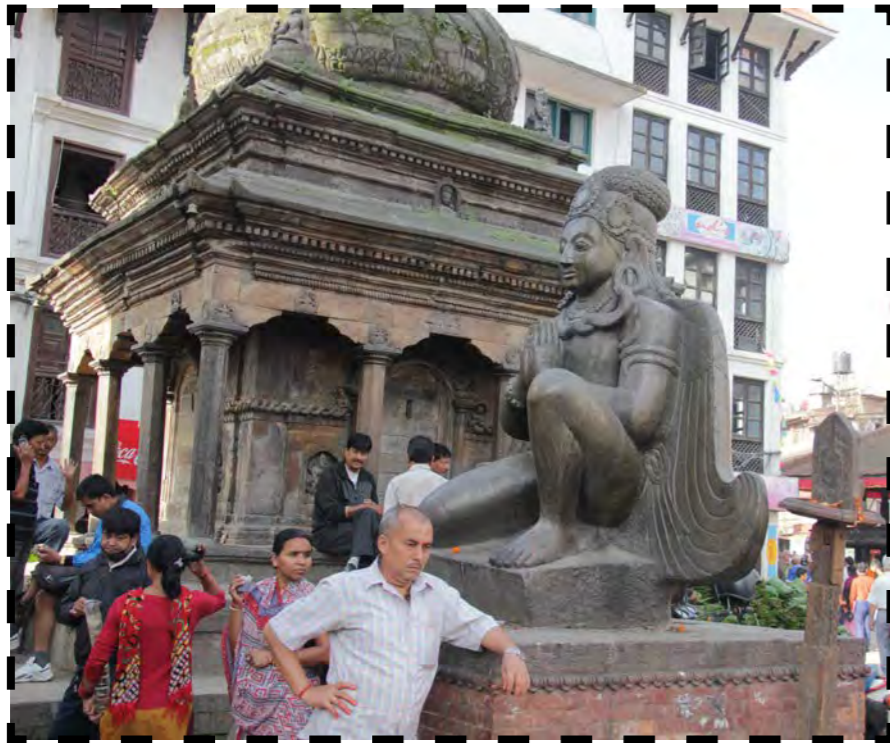

CODE NO	TYOLOGY	MONUMENT NAME	ESTABLISHED/ RENOVATED	STRUCTURAL SYSTEM	MATERIAL	GENERAL DESCRIPTION	PROBLEM DESCRIPTION	DANGER	REMARKS
54	Shikhara	Bimaleshwor Mahadev	1693	Load Bearing	Stone	Temple on raised plinth; Dome on top; Façade with carving of deities	Vegetation growth; Cracks on dome structure and unstable		

55 NARAYAN TEMPLE

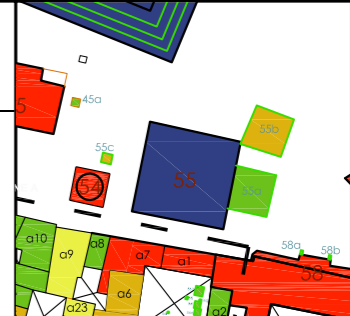

CODE NO	TYOLOGY	MONUMENT NAME	ESTABLISHED/ RENOVATED	STRUCTURAL SYSTEM	MATERIAL	GENERAL DESCRIPTION	PROBLEM DESCRIPTION	DANGER	REMARKS	
55	Three-storied temple	Narayan Temple	1690	Load Bearing	Brick	Raised above road level on plinths of varying height	Totally collapsed with shrine remaining; Extensive cracks on plinth; Certain parts detached.			

55a,b



CODE NO	TYOLOGY	MONUMENT NAME	ESTABLISHED/ RENOVATED	STRUCTURAL SYSTEM	MATERIAL	GENERAL DESCRIPTION	PROBLEM DESCRIPTION	DANGER	REMARKS
55a	Mandala					3 Mandalas on raised platform in front of temple	No visible damage		
55b	Platform				Stone	Raised stone platform	Vegetation growth; Cracks on four side of wall; Corner collapsed		

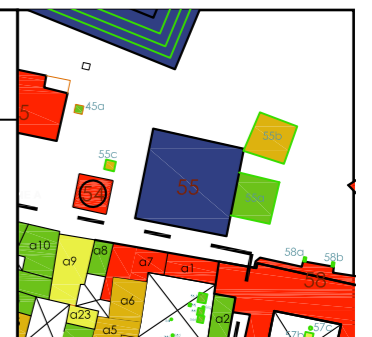

55c GARUD



CODE NO	TPOLOGY	MONUMENT NAME	ESTABLISHED/ RENOVATED	STRUCTURAL SYSTEM	MATERIAL	GENERAL DESCRIPTION	PROBLEM DESCRIPTION	DANGER	REMARKS
55c	Guard				Stone; Brick	Stone guard lion on raised brick platform	Garud settled and bricks in the corner detached.		

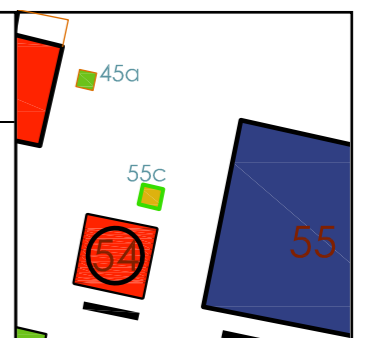

56 SIKHONMU BAHAL

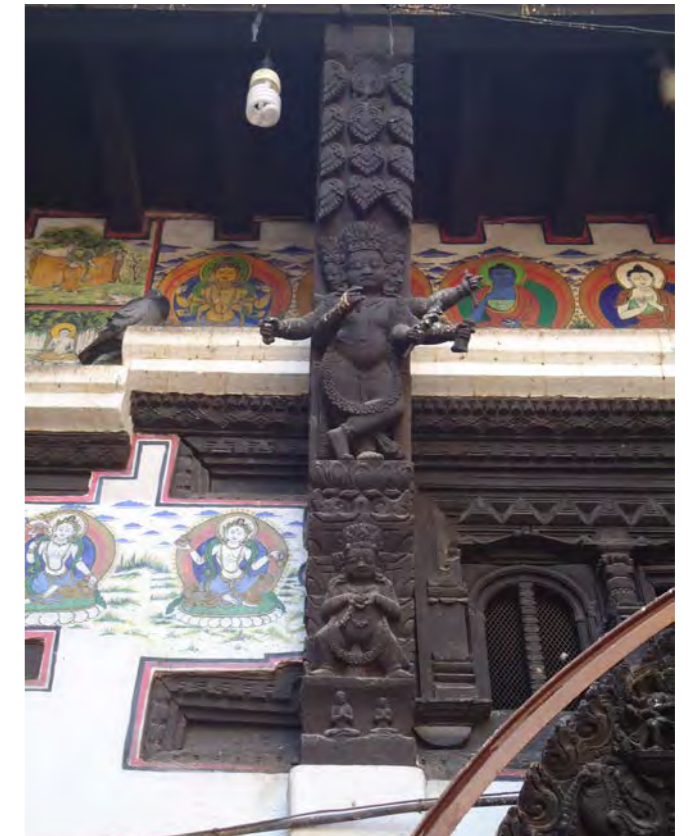

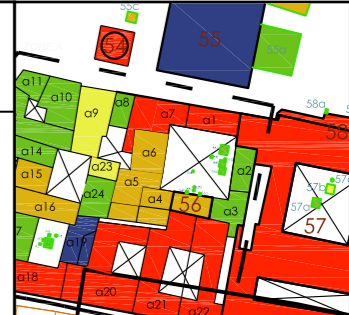
CODE NO	TYOLOGY	MONUMENT NAME	ESTABLISHED/ RENOVATED	STRUCTURAL SYSTEM	MATERIAL	GENERAL DESCRIPTION	PROBLEM DESCRIPTION	DANGER	REMARKS	
56	Bahal	Sikhonmu Bahal		Load Bearing	Brick	Timber roof with carved struts and projection on top floor; dooreay, torna windows represent the ten wraths of Buddhism	Minor cracks on walls			

56a



56b

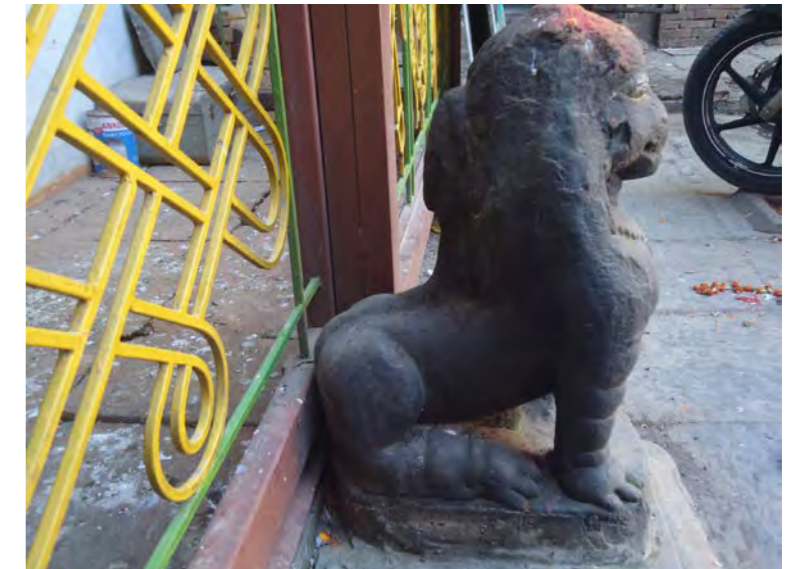

CODE NO	TYOLOGY	MONUMENT NAME	ESTABLISHED/ RENOVATED	STRUCTURAL SYSTEM	MATERIAL	GENERAL DESCRIPTION	PROBLEM DESCRIPTION	DANGER	REMARKS
56a	Guard lion				Stone	Stone guard lion on left side	No visible damage		
56b	Guard lion				Stone	Stone guard lion on right side	No visible damage		

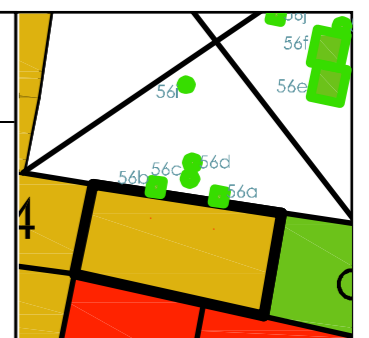

56c



56d



56e



CODE NO	TYOLOGY	MONUMENT NAME	ESTABLISHED/ RENOVATED	STRUCTURAL SYSTEM	MATERIAL	GENERAL DESCRIPTION	PROBLEM DESCRIPTION	DANGER	REMARKS
56c	Mandala				Stone	Mandala infront of temple			
56d	Stupa				Stone		Slightly dilapadated		
56e	Open Shrine				Stone	Stone shrine with Buddha image on four side	Vegetation growth		

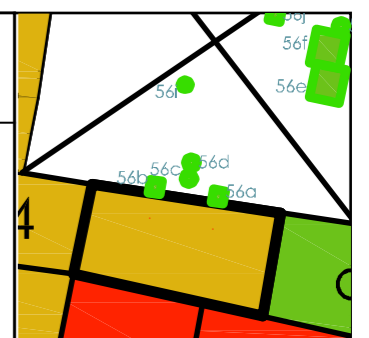

56f,g



56h



CODE NO	TYOLOGY	MONUMENT NAME	ESTABLISHED/ RENOVATED	STRUCTURAL SYSTEM	MATERIAL	GENERAL DESCRIPTION	PROBLEM DESCRIPTION	DANGER	REMARKS	
56f	Open shrine				Stone	Stone shrine with Buddha image on four side	Vegetaion growth and minor cracks at base			
56g	Stupa				Stone	Small stone stupa	Top part dilapadated; stones detoriated;vegetaion growth			
56h	Open shrine				Stone		Cracks at base and vegetation growth			

57 KUMARI BAHAL



CODE NO	TYOLOGY	MONUMENT NAME	ESTABLISHED/ RENOVATED	STRUCTURAL SYSTEM	MATERIAL	GENERAL DESCRIPTION	PROBLEM DESCRIPTION	DANGER	REMARKS
57	Bahal	Kumari Baha	18 century	Load Bearing	Brick	Part of the house of Kumari; Shrine of Buddha on sothern side of the courtyard.	Vegetation growth		

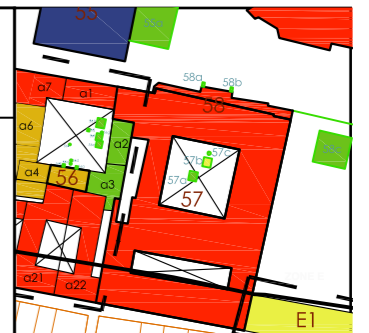

57a



57b



57c



CODE NO	TYOLOGY	MONUMENT NAME	ESTABLISHED/ RENOVATED	STRUCTURAL SYSTEM	MATERIAL	GENERAL DESCRIPTION	PROBLEM DESCRIPTION	DANGER	REMARKS
57a	Mandala				Stone	Sorrounded by wooden frame	No visible damage		
57b	Chaitya				Stone	"	No visible damage		
57c	Dharmadhatu				Stone	Stone inscription with plaster at base	No visible damage		

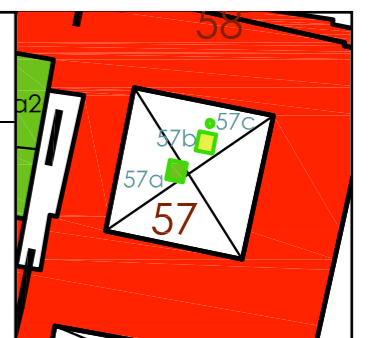

58 KUMARI DYO CHEIN

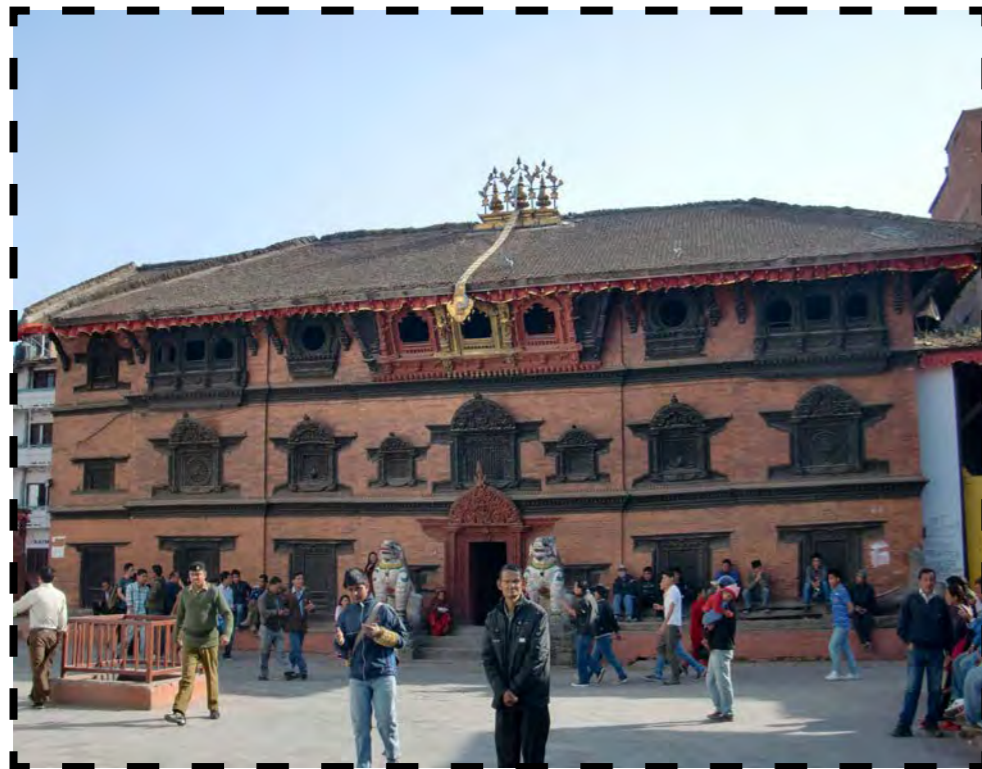

CODE NO	TYOLOGY	MONUMENT NAME	ESTABLISHED/ RENOVATED	STRUCTURAL SYSTEM	MATERIAL	GENERAL DESCRIPTION	PROBLEM DESCRIPTION	DANGER	REMARKS
58	Dyo chhen	Kumari Dyo chhen	18th century	Load Bearing	Brick; Timber	House of kumari goddess; Lime plastered with latticed windows and a window balcony	Extensive internal cracks; Unstable and currently supported by struts		

59 BANIYA BAHAL



CODE NO	TYOLOGY	MONUMENT NAME	ESTABLISHED/ RENOVATED	STRUCTURAL SYSTEM	MATERIAL	GENERAL DESCRIPTION	PROBLEM DESCRIPTION	DANGER	REMARKS	
59	Closed Shrine	Baniya bahal		Load Bearing	Brick	Marble cladding on wall;Cement plaster on top;Buddha statue inside	Good condition;Top bajra slightly tilted			

60 Saraswati Temple



CODE NO	TYOLOGY	MONUMENT NAME	ESTABLISHED/ RENOVATED	STRUCTURAL SYSTEM	MATERIAL	GENERAL DESCRIPTION	PROBLEM DESCRIPTION	DANGER	REMARKS	
60	Closed Shrine	Saraswati temple		Load Bearing	Brick	At a lower level from ground level; Marble cladding on wall; Cement plaster on top and two stone sculptures of saraswati	No visible damage			

61 Krishna Temple



61a Kumari Temple



CODE NO	TYOLOGY	MONUMENT NAME	ESTABLISHED/ RENOVATED	STRUCTURAL SYSTEM	MATERIAL	GENERAL DESCRIPTION	PROBLEM DESCRIPTION	DANGER	REMARKS
61		Krishna Temple			Brick		Totally collapsed		



62 Stupa

62a



CODE NO	TYOLOGY	MONUMENT NAME	ESTABLISHED/ RENOVATED	STRUCTURAL SYSTEM	MATERIAL	GENERAL DESCRIPTION	PROBLEM DESCRIPTION	DANGER	REMARKS
62	Stupa			Load Bearing	Brick	Cement stupa with white washing;Sculpture of bud-dha on both side	Rising damp;Vegetation growth		
62a	Inscription				Stone	Inscription on front face	No visible damage		



62b 62c



62d



CODE NO	TYOLOGY	MONUMENT NAME	ESTABLISHED/ RENOVATED	STRUCTURAL SYSTEM	MATERIAL	GENERAL DESCRIPTION	PROBLEM DESCRIPTION	DANGER	REMARKS
62b 62c	Statue				Stone		No visible damage		
62d	Open shrine	Bajrakaal Bhai-rab		Load Bearing	Brick	Small stone sculpture	No visible damage		

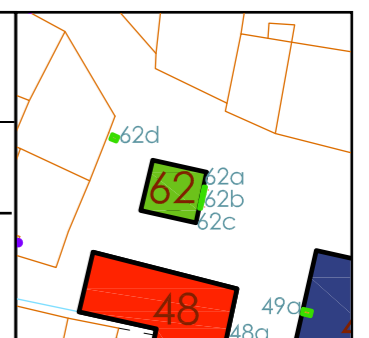

63 Masan Chowk

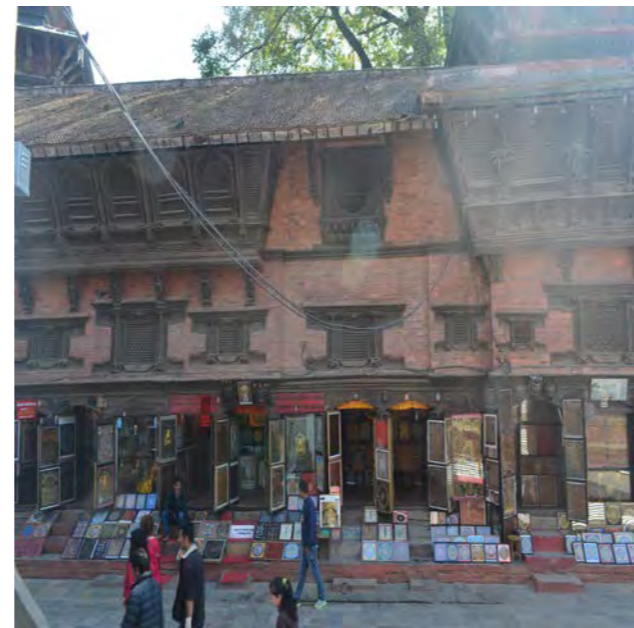
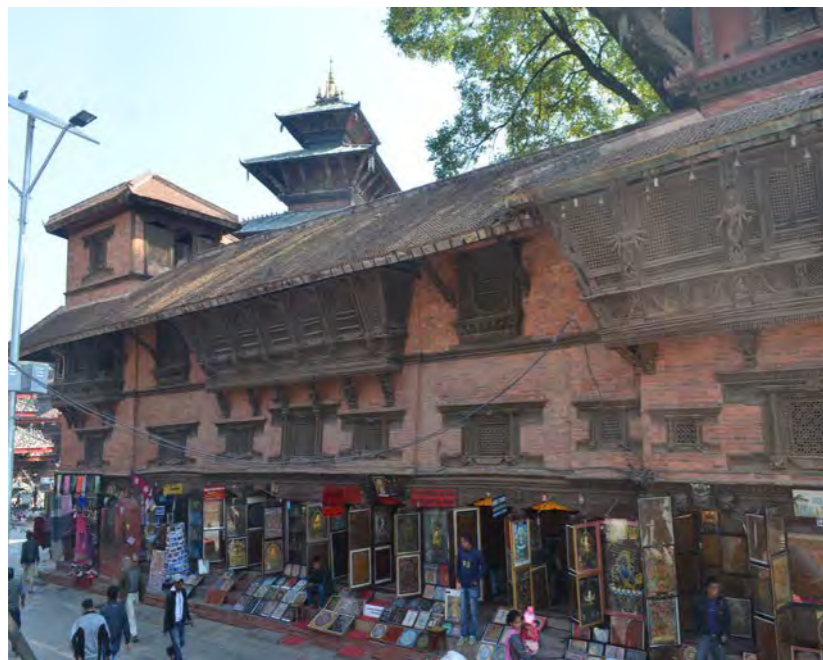

CODE NO	TYOLOGY	MONUMENT NAME	ESTABLISHED/ RENOVATED	STRUCTURAL SYSTEM	MATERIAL	GENERAL DESCRIPTION	PROBLEM DESCRIPTION	DANGER	REMARKS
63	Courtyard	Masan Chowk					Vegetation growth;Dampness problem		



63a Nashal Temple



63b well



CODE NO	TYOLOGY	MONUMENT NAME	ESTABLISHED/ RENOVATED	STRUCTURAL SYSTEM	MATERIAL	GENERAL DESCRIPTION	PROBLEM DESCRIPTION	DANGER	REMARKS
63a	Three storey temple	Nashal Temple		Load Bearing	Brick		Slightly tilted towards north;vegetation growth		
63b		Well			Brick		Vegetation growth		

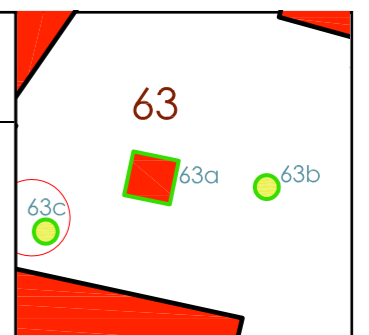

64 Dhak Chwok

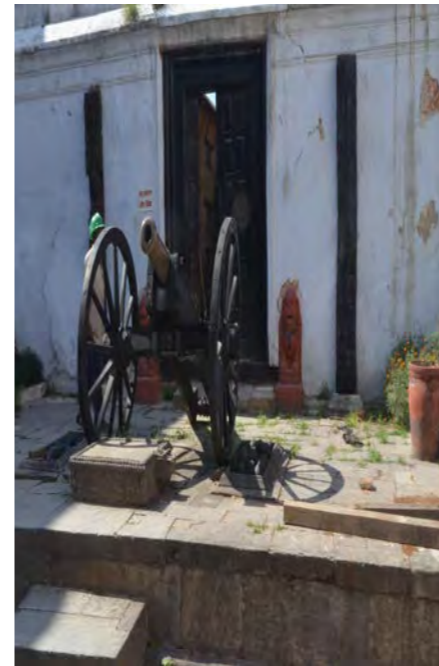





CODE NO	TYOLOGY	MONUMENT NAME	ESTABLISHED/ RENOVATED	STRUCTURAL SYSTEM	MATERIAL	GENERAL DESCRIPTION	PROBLEM DESCRIPTION	DANGER	REMARKS	
64	Courtyard	Dhak Chowk					Extensive cracks and bulging in the buildings surrounding the courtyard			

65 Bayou Chwok

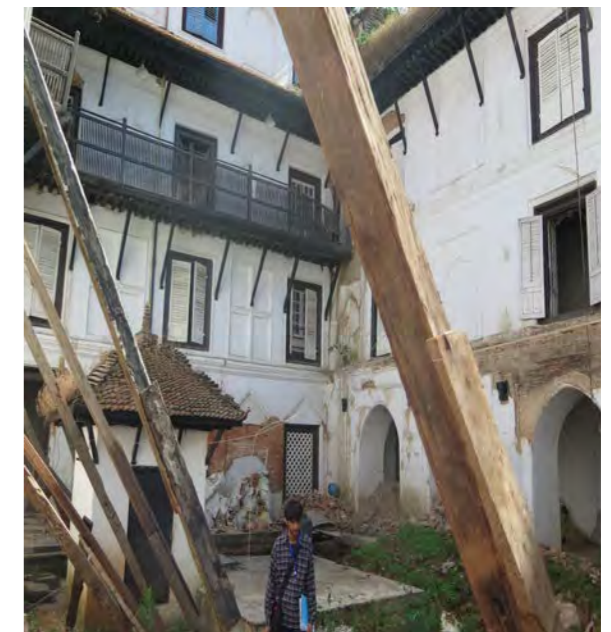
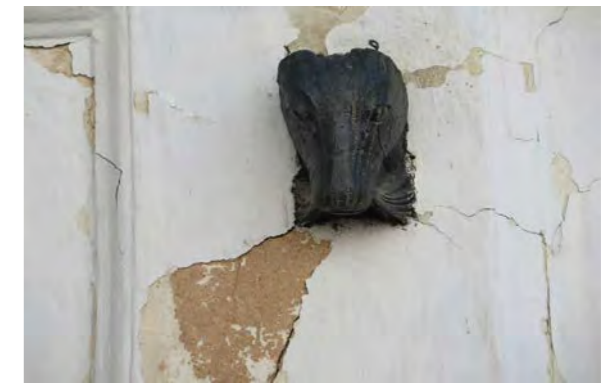
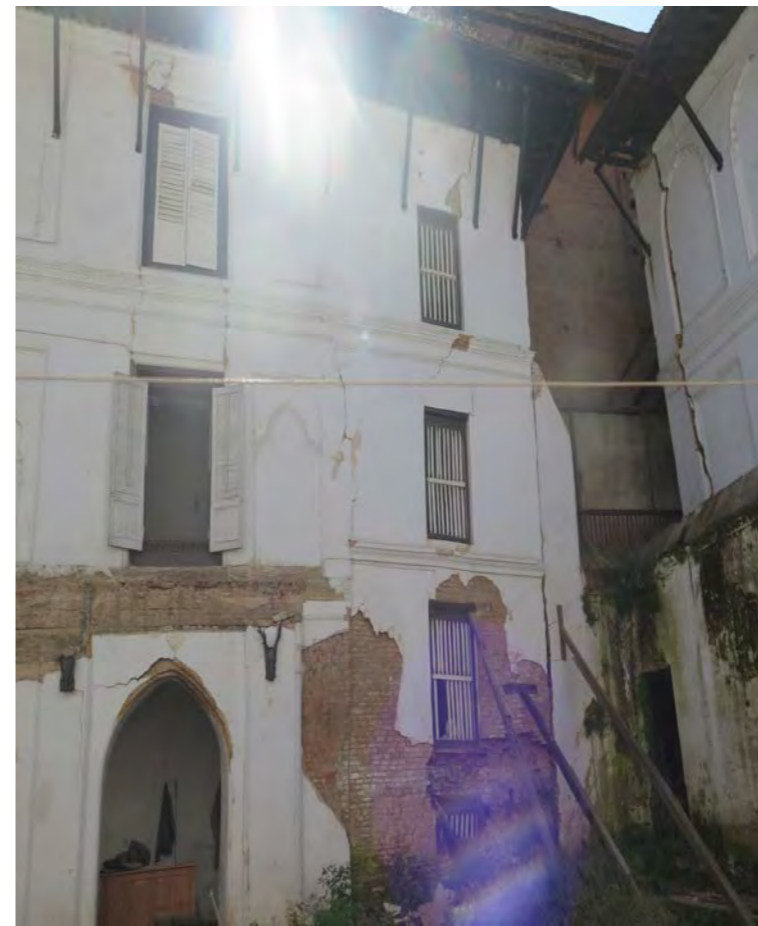



CODE NO	TYOLOGY	MONUMENT NAME	ESTABLISHED/ RENOVATED	STRUCTURAL SYSTEM	MATERIAL	GENERAL DESCRIPTION	PROBLEM DESCRIPTION	DANGER	REMARKS	
65	Courtyard	Bayou chowk					Extensive cracks and bulging in the buildings surrounding the courtyard			

66 Gaddi Baithak Chowk



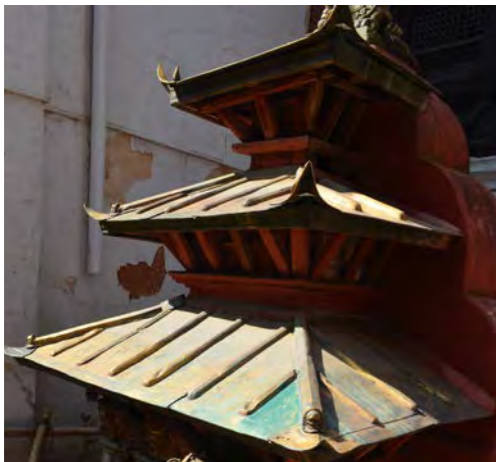

CODE NO	TYOLOGY	MONUMENT NAME	ESTABLISHED/ RENOVATED	STRUCTURAL SYSTEM	MATERIAL	GENERAL DESCRIPTION	PROBLEM DESCRIPTION	DANGER	REMARKS
66		Gaddi Baithak Chowk					Extensive cracks in walls. Bulging of walls; Corner separation in North walls; Wooden posts and columns in building deteriorated.		

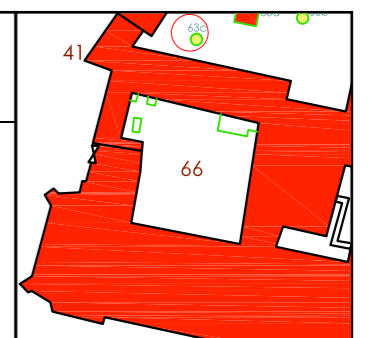

67 GUARDING LIONS



CODE NO	TYOLOGY	MONUMENT NAME	ESTABLISHED/ RENOVATED	STRUCTURAL SYSTEM	MATERIAL	GENERAL DESCRIPTION	PROBLEM DESCRIPTION	DANGER	REMARKS	
67	stone lion					coloured, carved by grill	No visible damage			

A1

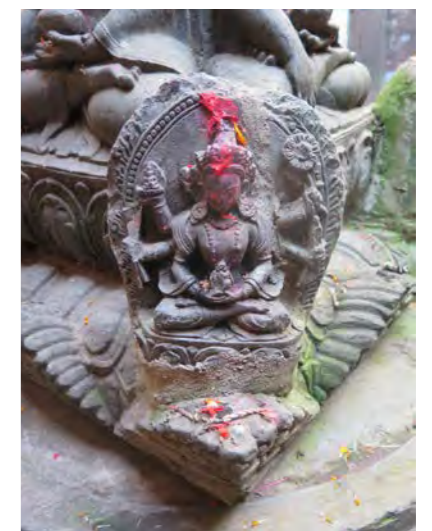
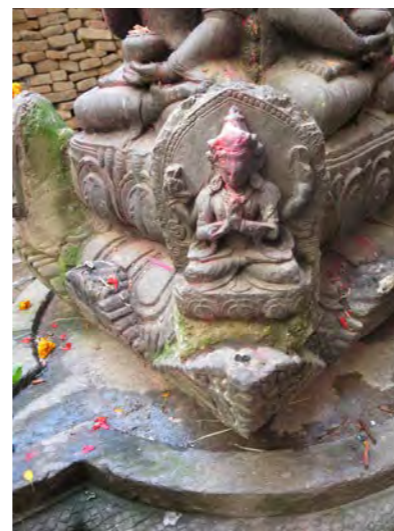
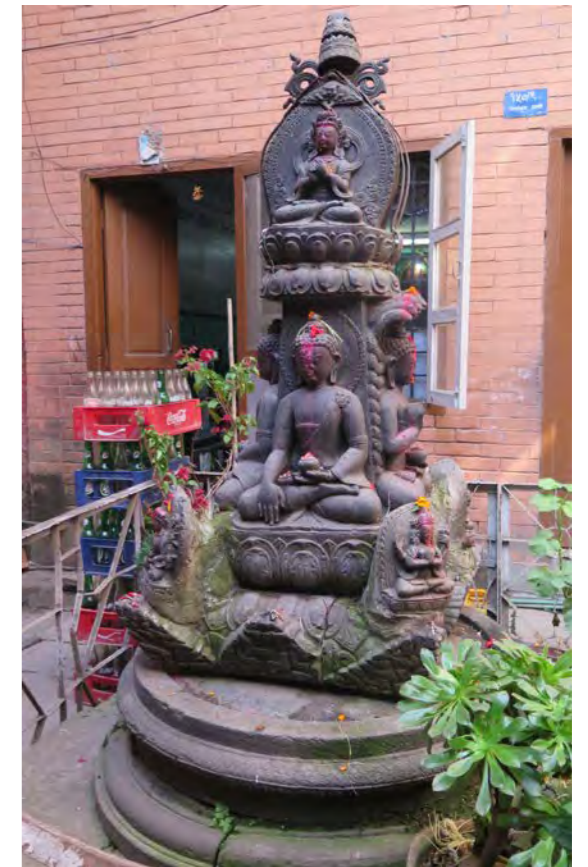

CODE NO	TYOLOGY	MONUMENT NAME	ESTABLISHED/ RENOVATED	STRUCTURAL SYSTEM	MATERIAL	GENERAL DESCRIPTION	PROBLEM DESCRIPTION	DANGER	REMARKS
A1	Chaitya				Stone	Stone chaitya with buddha image on four side surrounded by metal fence	Cracks at base and vegetation growth		

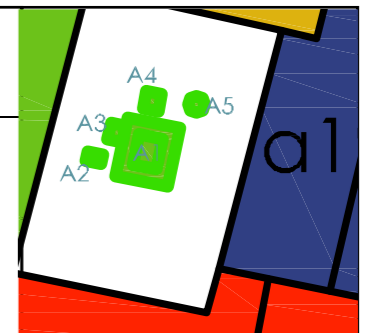

A2

A3

A4

A5



CODE NO	TYOLOGY	MONUMENT NAME	ESTABLISHED/ RENOVATED	STRUCTURAL SYSTEM	MATERIAL	GENERAL DESCRIPTION	PROBLEM DESCRIPTION	DANGER	REMARKS
A2	Statue				Stone	Cement plastered stone statue of owners	No visible damage		
A3	Inscription				Stone	Cement plastered stone statue of owners	No visible damage		
A4	Yagya				Brick	yagya sorrouned by brick	No visible damage		
A5	Mandala				Stone	Stone mandala	No visble damage		

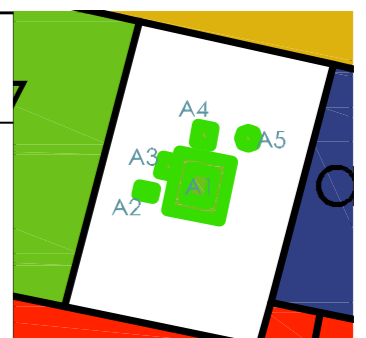

RESIDENTIAL BUILDINGS



50

50a

50b

ZONE A

55c

54

55

55a

a11

a10

a9

a8

a7

a1

58a

58b

58

a12

a14

a15

a23

a5

a6

a2

57b

57c

57a

57

53

a16

a24

a4

56

a3

a17

A4
A3
A2

a19

52

a18

a20

a21

a22

ZON

E

RESIDENTIAL BUILDINGS

ZONE A

a01



Source: Sharad Man Shakya
Date: 13th May 15



CODE NO	OWNERS NAME/CONTACT	STOREY NUMBER	PRESENT STOREY NUMBER	STRUCTURAL SYSTEM	MATERIAL	GENERAL DESCRIPTION	PROBLEM DESCRIPTION	DANGER	Heritage Significance	REMARKS
a01	Nani Maya Joshi	G+3	G+1	Load Bearing	Uncooked Brick		Two storey collapsed;Cracks in found floor;Rising damp;Vegetation growth			

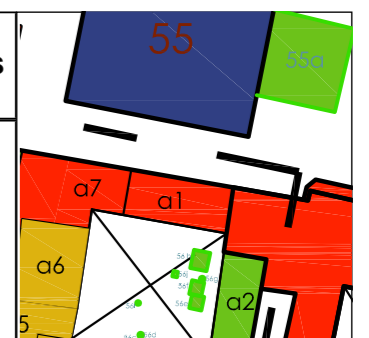

a02



CODE NO	OWNERS NAME/CONTACT	STOREY NUMBER	PRESENT STOREY NUMBER	STRUCTURAL SYSTEM	MATERIAL	GENERAL DESCRIPTION	PROBLEM DESCRIPTION	DANGER	Heritage Significance	REMARKS
a02	Nani Maya Joshi	G+3	G+1	Load Bearing	Uncooked Brick		Two storey collapsed;Cracks in found floor;Rising damp;Vegetation growth			

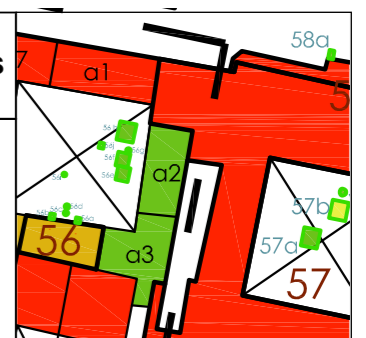

a04 a05



CODE NO	OWNERS NAME/CONTACT	STOREY NUMBER	PRESENT STOREY NUMBER	STRUCTURAL SYSTEM	MATERIAL	GENERAL DESCRIPTION	PROBLEM DESCRIPTION	DANGER	Heritage Significance	REMARKS
a04	Iaxmi Shakya	G+4	G+4	Frame	Cement	Rcc slab roof with marble cladding	Minor cracks in walls			
a05	Prem Shova Tuladhar	G+3	G+3	Frame	Cement	Cement Plastered	Minor cracks in walls			

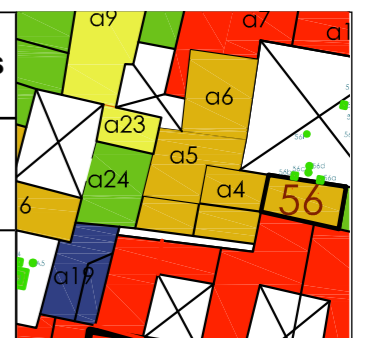

a06

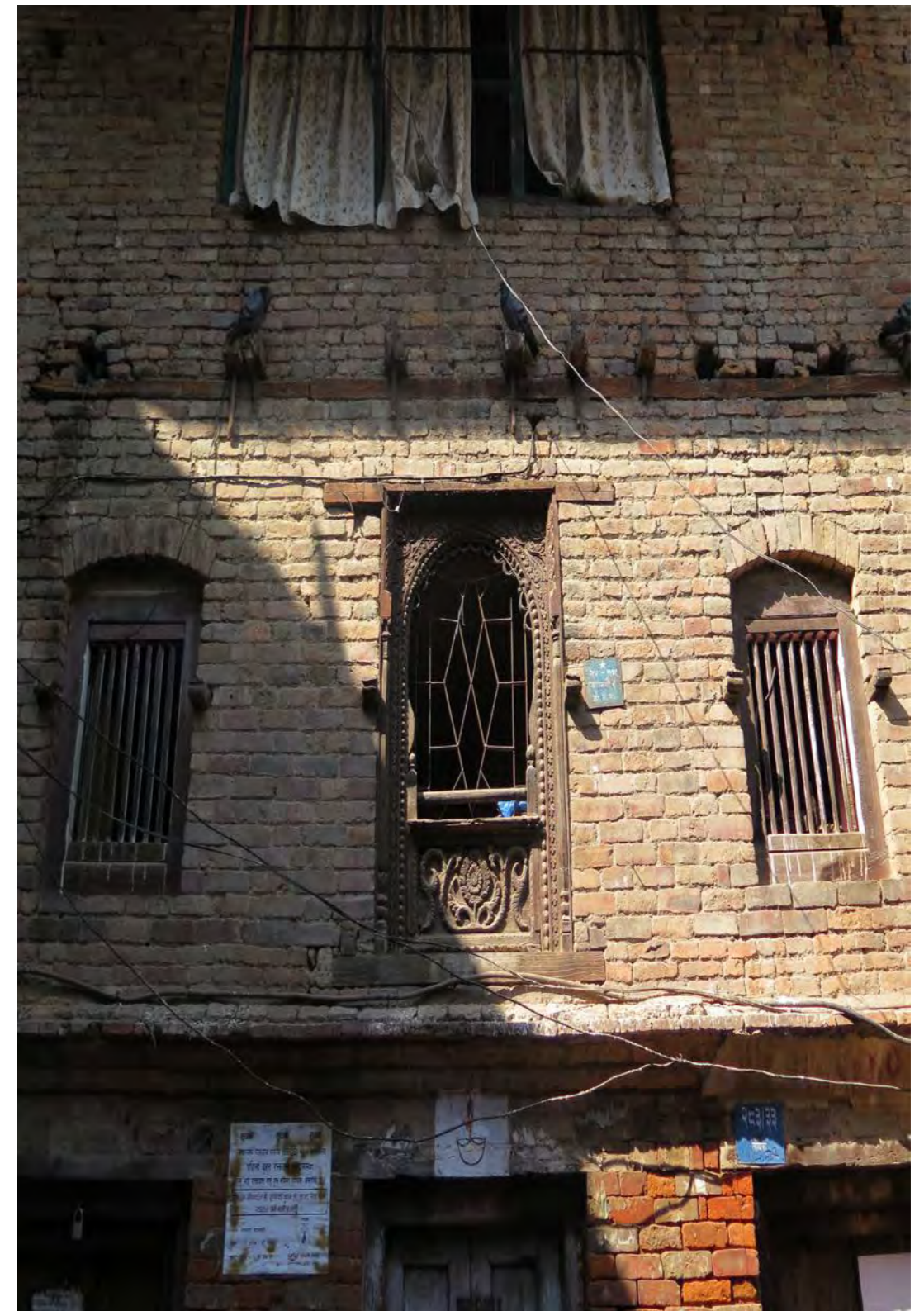

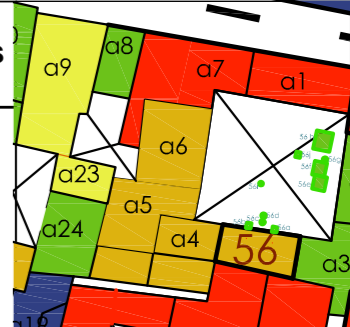
CODE NO	OWNERS NAME/CONTACT	STOREY NUMBER	PRESENT STOREY NUMBER	STRUCTURAL SYSTEM	MATERIAL	GENERAL DESCRIPTION	PROBLEM DESCRIPTION	DANGER	Heritage Significance	REMARKS
a06	Pushpa Ratna Bajracharya	G+2	G+2	Load Bearing	Brick	Tin roof; Timber doors and window with carving	Bulging of walls in ground and first floor	D!	+	

a07



CODE NO	OWNERS NAME/CONTACT	STOREY NUMBER	PRESENT STOREY NUMBER	STRUCTURAL SYSTEM	MATERIAL	GENERAL DESCRIPTION	PROBLEM DESCRIPTION	DANGER	Heritage Significance	REMARKS
a07	Ganesh Dev Pantha	G+4	G+4	Load Bearing	Brick	Tin roof; Timber doors and window with carving	Bulging of walls and currently supported by struts	D!		

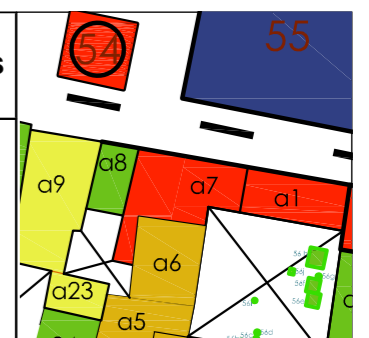

a08



CODE NO	OWNERS NAME/CONTACT	STOREY NUMBER	PRESENT STOREY NUMBER	STRUCTURAL SYSTEM	MATERIAL	GENERAL DESCRIPTION	PROBLEM DESCRIPTION	DANGER	Heritage Significance	REMARKS
a08	Narayan Maharjan	G+4	G+4	Load Bearing	Brick; Timber		No visible damage			

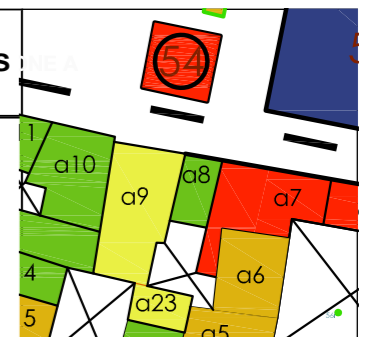

a09



CODE NO	OWNERS NAME/CONTACT	STOREY NUMBER	PRESENT STOREY NUMBER	STRUCTURAL SYSTEM	MATERIAL	GENERAL DESCRIPTION	PROBLEM DESCRIPTION	DANGER	Heritage Significance	REMARKS
a09	Deepak kani-kar	G+4	G+4	Load Bearing	Brick;TImber	Minor Internal cracks	Moderate internal cracks present			

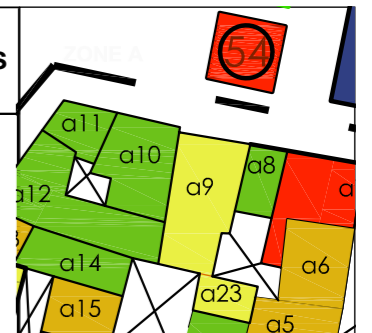

a10



CODE NO	OWNERS NAME/CONTACT	STOREY NUMBER	PRESENT STOREY NUMBER	STRUCTURAL SYSTEM	MATERIAL	GENERAL DESCRIPTION	PROBLEM DESCRIPTION	DANGER	Heritage Significance	REMARKS
a10	Bhagwati Joshi	G+5	G+5	Load Bearing	Brick; Timber		No visible damage			

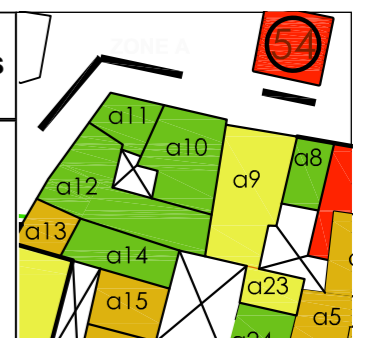

a11



CODE NO	OWNERS NAME/CONTACT	STOREY NUMBER	PRESENT STOREY NUMBER	STRUCTURAL SYSTEM	MATERIAL	GENERAL DESCRIPTION	PROBLEM DESCRIPTION	DANGER	Heritage Significance	REMARKS
a11	ND's	G+4	G+4	Frame	Cement		No visible damage			

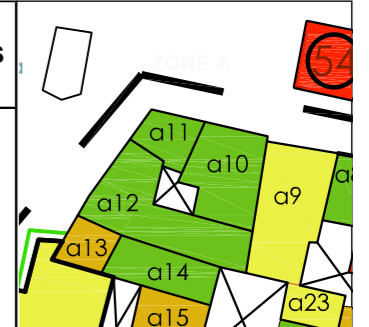

a12

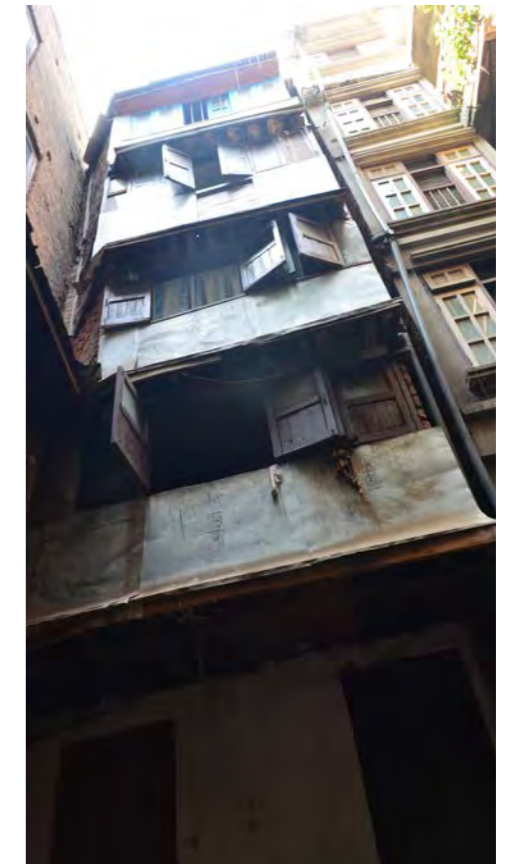

CODE NO	OWNERS NAME/CONTACT	STOREY NUMBER	PRESENT STOREY NUMBER	STRUCTURAL SYSTEM	MATERIAL	GENERAL DESCRIPTION	PROBLEM DESCRIPTION	DANGER	Heritage Significance	REMARKS
a12	Bhagwati Joshi	G+4	G+4	Frame	Cement		No visible damage			



a13

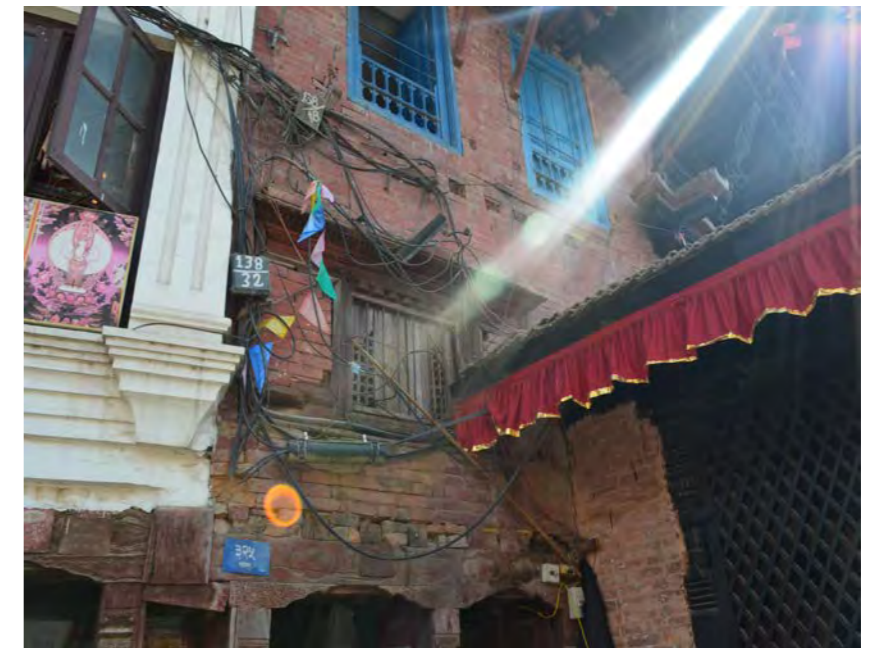

CODE NO	OWNERS NAME/CONTACT	STOREY NUMBER	PRESENT STOREY NUMBER	STRUCTURAL SYSTEM	MATERIAL	GENERAL DESCRIPTION	PROBLEM DESCRIPTION	DANGER	Heritage Significance	REMARKS
a13	Indu Kumari Maya	G+4	G+4	Frame	Cement		No visible damage			

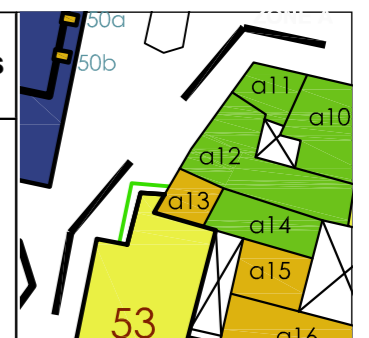

a14



CODE NO	OWNERS NAME/CONTACT	STOREY NUMBER	PRESENT STOREY NUMBER	STRUCTURAL SYSTEM	MATERIAL	GENERAL DESCRIPTION	PROBLEM DESCRIPTION	DANGER	Heritage Significance	REMARKS
a14	Indu kKumari Maya	G+5	G+5	Frame	Cement		No visible damage			

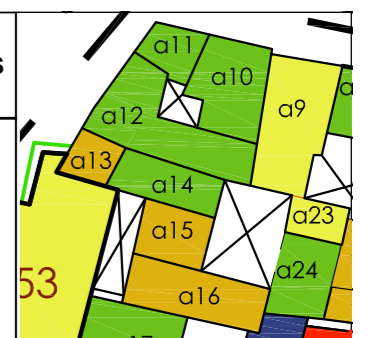

a15



CODE NO	OWNERS NAME/CONTACT	STOREY NUMBER	PRESENT STOREY NUMBER	STRUCTURAL SYSTEM	MATERIAL	GENERAL DESCRIPTION	PROBLEM DESCRIPTION	DANGER	Heritage Significance	REMARKS
a15	Ranjana Maya Shakya	G+5	G+5	Frame	Cement		No visible damage			

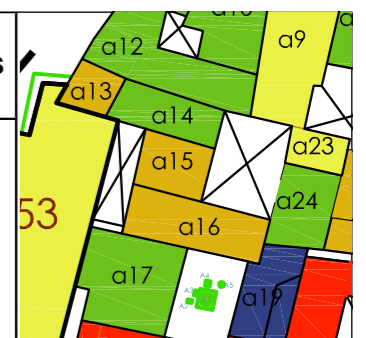

a16



CODE NO	OWNERS NAME/CONTACT	STOREY NUMBER	PRESENT STOREY NUMBER	STRUCTURAL SYSTEM	MATERIAL	GENERAL DESCRIPTION	PROBLEM DESCRIPTION	DANGER	Heritage Significance	REMARKS
a16	Narendra Bahadur Chitrakar	G+4	G+4	Load Bearing	Brick	Tin roof with Verendha on top floor	Moderate internal cracks		+	

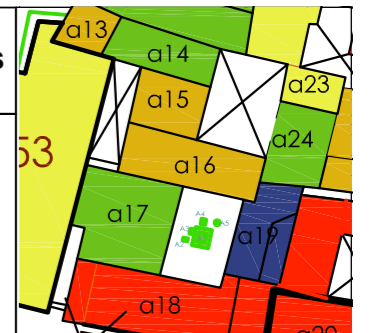

a17



CODE NO	OWNERS NAME/CONTACT	STOREY NUMBER	PRESENT STOREY NUMBER	STRUCTURAL SYSTEM	MATERIAL	GENERAL DESCRIPTION	PROBLEM DESCRIPTION	DANGER	Heritage Significance	REMARKS
a17	Gopal Das Manandhar	G+4	G+4	Frame	Cement	Modern building with RCC frame, brick cladding and carved windows	Minor Internal Cracks			



a18



CODE NO	OWNERS NAME/CONTACT	STOREY NUMBER	PRESENT STOREY NUMBER	STRUCTURAL SYSTEM	MATERIAL	GENERAL DESCRIPTION	PROBLEM DESCRIPTION	DANGER	Heritage Significance	REMARKS
a18	Basundhara Bhakta Manandhar	G+3	G+3	Load Bearing	Brick		Partly collapsed; Extensive cracking and bulging of walls		+	

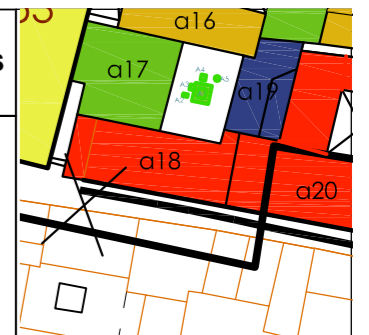

a19



CODE NO	OWNERS NAME/CONTACT	STOREY NUMBER	PRESENT STOREY NUMBER	STRUCTURAL SYSTEM	MATERIAL	GENERAL DESCRIPTION	PROBLEM DESCRIPTION	DANGER	Heritage Significance	REMARKS
a19	Rajendra Bajracharya	G+2	-	Load Bearing	Brick		Totally Collapsed			

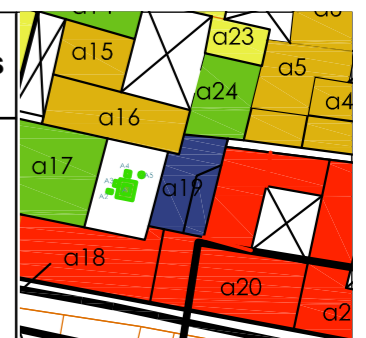

a20



CODE NO	OWNERS NAME/CONTACT	STOREY NUMBER	PRESENT STOREY NUMBER	STRUCTURAL SYSTEM	MATERIAL	GENERAL DESCRIPTION	PROBLEM DESCRIPTION	DANGER	Heritage Significance	REMARKS
a20		G+4	G+4	Load Bearing	Brick		Bulging of walls; Extensive cracking			

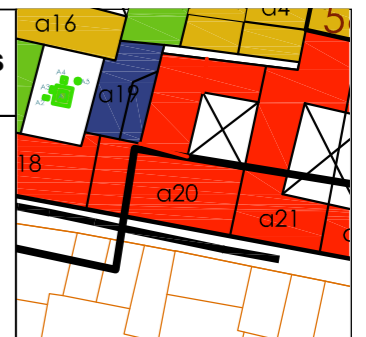

a21

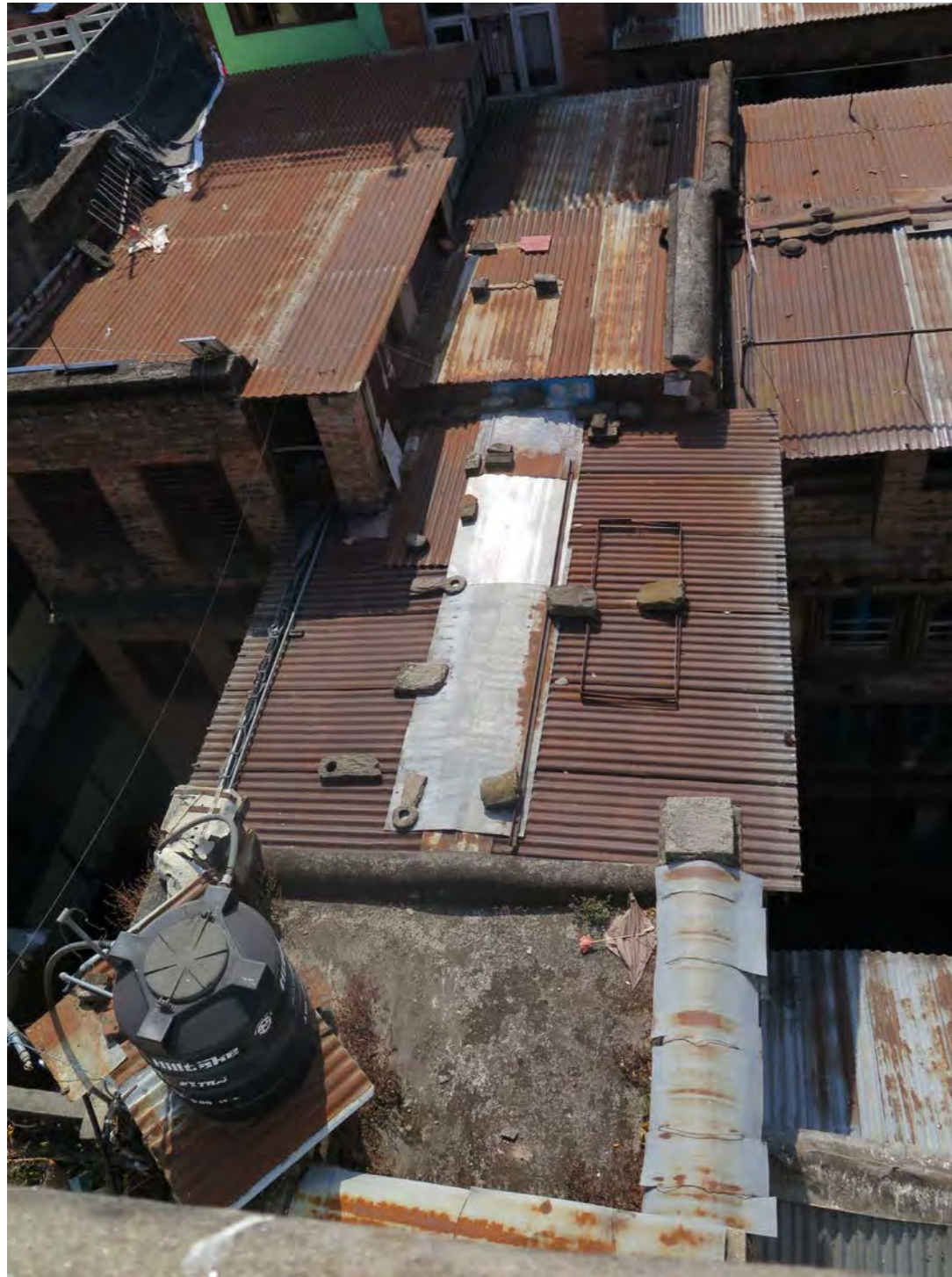

CODE NO	OWNERS NAME/CONTACT	STOREY NUMBER	PRESENT STOREY NUMBER	STRUCTURAL SYSTEM	MATERIAL	GENERAL DESCRIPTION	PROBLEM DESCRIPTION	DANGER	Heritage Significance	REMARKS
a21		G+4	G+4	Load Bearing	Brick		No visible damage			

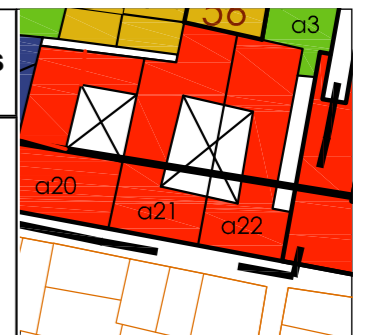

a22



CODE NO	OWNERS NAME/CONTACT	STOREY NUMBER	PRESENT STOREY NUMBER	STRUCTURAL SYSTEM	MATERIAL	GENERAL DESCRIPTION	PROBLEM DESCRIPTION	DANGER	Heritage Significance	REMARKS
a22		G+4	G+4	Load Bearing	Brick		No visible damage			

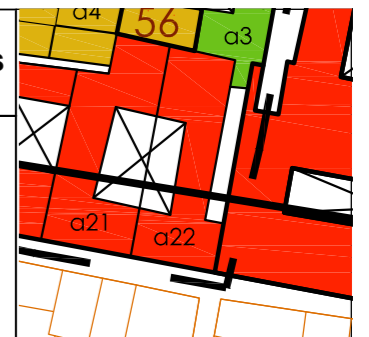

a23



a24



CODE NO	OWNERS NAME/CONTACT	STOREY NUMBER	PRESENT STOREY NUMBER	STRUCTURAL SYSTEM	MATERIAL	GENERAL DESCRIPTION	PROBLEM DESCRIPTION	DANGER	Heritage Significance	REMARKS
a23		G+4	G+4	Frame	Cement		No visible damage			
a24		G+4	G+4	Frame	Cement		No visible damage			

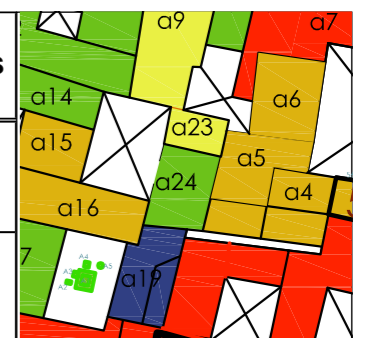



46
46a
46b
46c
46d

45b

45a

49c 49d

48a
48b
48c

49a

62
62a
62b
62c

62d

ZONE B

c1

42

44

43

b7

b8

b9

b6

b5

b4

b3

b2

b16

b1

b14

b15

b13

b10

b12

b11

47

48

49

49b

45

RESIDENTIAL BUILDINGS

ZONE B

b1



CODE NO	OWNERS NAME/ CONTACT	STOREY NUM- BER	PRESENT STO- REY NUMBER	STRUCTURAL SYSTEM	MATERIAL	GENERAL DESCEIPTION	PROBLEM DESCRIPTION	DANGER	Heritage Sig- nificance	REMARKS
b01	Narayan Dhoj Joshi	G+4	G+4	Load Bearing	Brick	Tin roof with cement plaster	Extensive internal cracks; Currently inhabitaed			

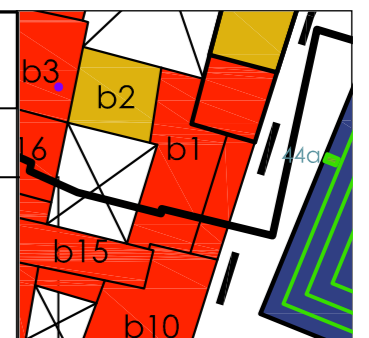

b2



CODE NO	OWNERS NAME/ CONTACT	STOREY NUM- BER	PRESENT STO- REY NUMBER	STRUCTURAL SYSTEM	MATERIAL	GENERAL DESCEIPTION	PROBLEM DESCRIPTION	DANGER	Heritage Sig- nificance	REMARKS
b02	Bijay Dhoj Joshi	G+4	G+4	Load Bearing	Brick	Tin roof with cement plaster	Extensive internal cracks			

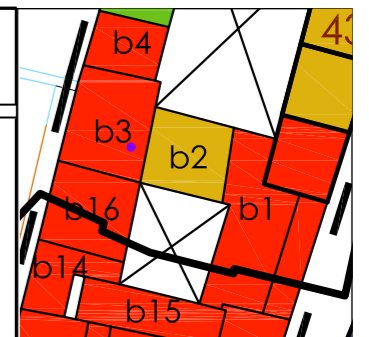

b3 b4



CODE NO	OWNERS NAME/ CONTACT	STOREY NUM- BER	PRESENT STO- REY NUMBER	STRUCTURAL SYSTEM	MATERIAL	GENERAL DESCEIPTION	PROBLEM DESCRIPTION	DANGER	Heritage Sig- nificance	REMARKS
b03	Prabin Pradhan	G+4	G+4	Load Bearing	Brick	Tin roof and outer façade not plastered	Minor internal cracks present			
b04	Diwas Shres- tha	G+3	G+3	Load Bearing	Brick		Bulging of walls and unstable	D!		

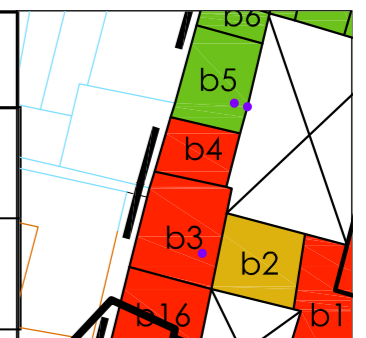

b5



CODE NO	OWNERS NAME/ CONTACT	STOREY NUM- BER	PRESENT STO- REY NUMBER	STRUCTURAL SYSTEM	MATERIAL	GENERAL DESCEIPTION	PROBLEM DESCRIPTION	DANGER	Heritage Sig- nificance	REMARKS
b05	Biswa Bikram Joshi	G+3	G+3	Frame	Cement;Brick	RCC frame with brick facade	No visible damage			

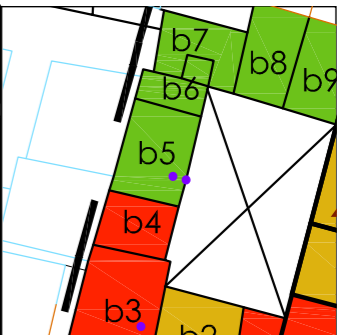

b6



CODE NO	OWNERS NAME/ CONTACT	STOREY NUM- BER	PRESENT STO- REY NUMBER	STRUCTURAL SYSTEM	MATERIAL	GENERAL DESCEIPTION	PROBLEM DESCRIPTION	DANGER	Heritage Sig- nificance	REMARKS	
b6	Sashi Bikram Joshi	G+3	G+3	Frame	Cement	RCC slab roof	Minor cracks in walls present				A site plan diagram showing the layout of buildings. Units are labeled b4, b5, b6, b7, b8, and b9. Unit b6 is highlighted in green. A yellow area is labeled 4. The diagram shows the relative positions of the buildings and units.

b7, b8, b9



CODE NO	OWNERS NAME/ CONTACT	STOREY NUM- BER	PRESENT STO- REY NUMBER	STRUCTURAL SYSTEM	MATERIAL	GENERAL DESCEIPTION	PROBLEM DESCRIPTION	DANGER	Heritage Sig- nificance	REMARKS
b07	Sashi Bikram Joshi	G+4	G+4	Frame	Cement	RCC slab roof	Minor cracks in walls			
b08	Devendra Raj Joshi	G+4	G+4	Frame	Cement;Brick	RCC frame with brick facade	No visible damage			
b09		G	G	Load Bearing	Brick	Used as shelter	No visible damage			

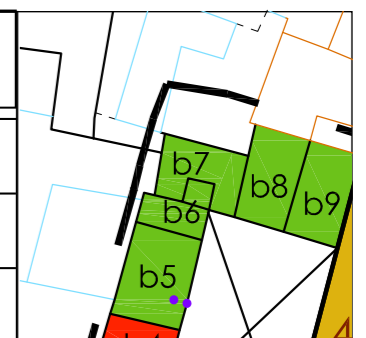

b10



CODE NO	OWNERS NAME/ CONTACT	STOREY NUM- BER	PRESENT STO- REY NUMBER	STRUCTURAL SYSTEM	MATERIAL	GENERAL DESCEIPTION	PROBLEM DESCRIPTION	DANGER	Heritage Sig- nificance	REMARKS
b10		G+3	G+3	Load Bearing	Brick		Extensive vertical Cracks			

b11



CODE NO	OWNERS NAME/ CONTACT	STOREY NUMBER	PRESENT STOREY NUMBER	STRUCTURAL SYSTEM	MATERIAL	GENERAL DESCRIPTION	PROBLEM DESCRIPTION	DANGER	Heritage Significance	REMARKS
b11	Kishor Shrestha	G+4.5	G+4	Load Bearing	Brick		Extensive cracking present			

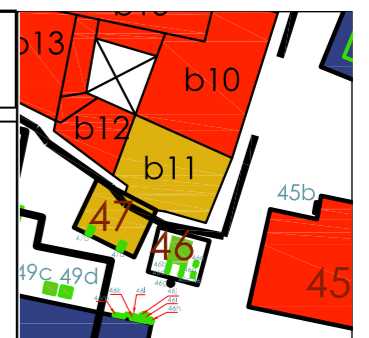

b12



CODE NO	OWNERS NAME/ CONTACT	STOREY NUM- BER	PRESENT STO- REY NUMBER	STRUCTURAL SYSTEM	MATERIAL	GENERAL DESCEIPTION	PROBLEM DESCRIPTION	DANGER	Heritage Sig- nificance	REMARKS
b12		G+4.5		Load Bearing	Brick		Minor cracks and bulging of walls			

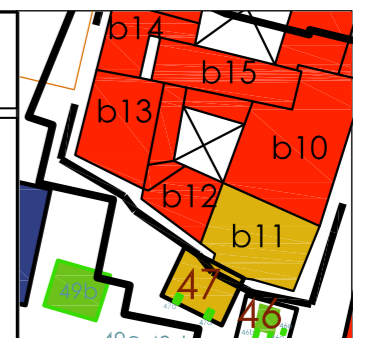

b13



CODE NO	OWNERS NAME/ CONTACT	STOREY NUM- BER	PRESENT STO- REY NUMBER	STRUCTURAL SYSTEM	MATERIAL	GENERAL DESCEIPTION	PROBLEM DESCRIPTION	DANGER	Heritage Sig- nificance	REMARKS
b13	Bidhya Vaidya	G+4	G+4	Load Bearing	Brick; Timber		Extensive cracking of walls; Settlement and bulging of walls			

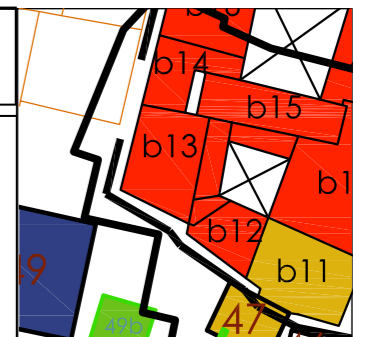

b14



CODE NO	OWNERS NAME/ CONTACT	STOREY NUM- BER	PRESENT STO- REY NUMBER	STRUCTURAL SYSTEM	MATERIAL	GENERAL DESCEIPTION	PROBLEM DESCRIPTION	DANGER	Heritage Sig- nificance	REMARKS
b14		G+4	G+4	Load Bearing	Brick;Timber		Top floor collapsed;Bulging of walls in remaining floors.			

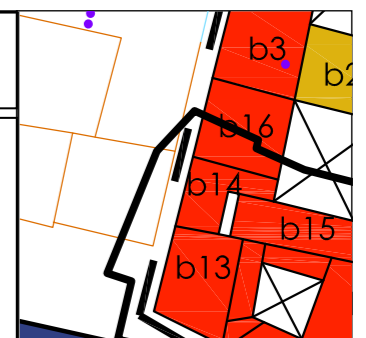

b15



CODE NO	OWNERS NAME/ CONTACT	STOREY NUM- BER	PRESENT STO- REY NUMBER	STRUCTURAL SYSTEM	MATERIAL	GENERAL DESCEIPTION	PROBLEM DESCRIPTION	DANGER	Heritage Sig- nificance	REMARKS
b15	Ramesh maha- rjan	G+2	G+2	Load Bearing	Brick		Extensive cracking of walls			

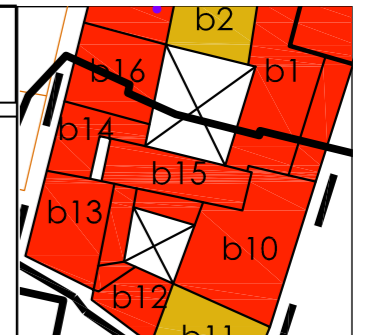

b16



CODE NO	OWNERS NAME/ CONTACT	STOREY NUM- BER	PRESENT STO- REY NUMBER	STRUCTURAL SYSTEM	MATERIAL	GENERAL DESCEIPTION	PROBLEM DESCRIPTION	DANGER	Heritage Sig- nificance	REMARKS
b16		G+4	G+4	Load Bearing	Brick;Timber		Extensive internal cracks and bulging of walls. Cracks in timber elements.			

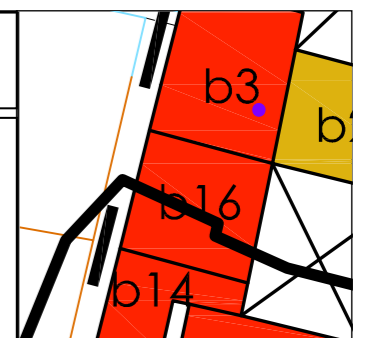

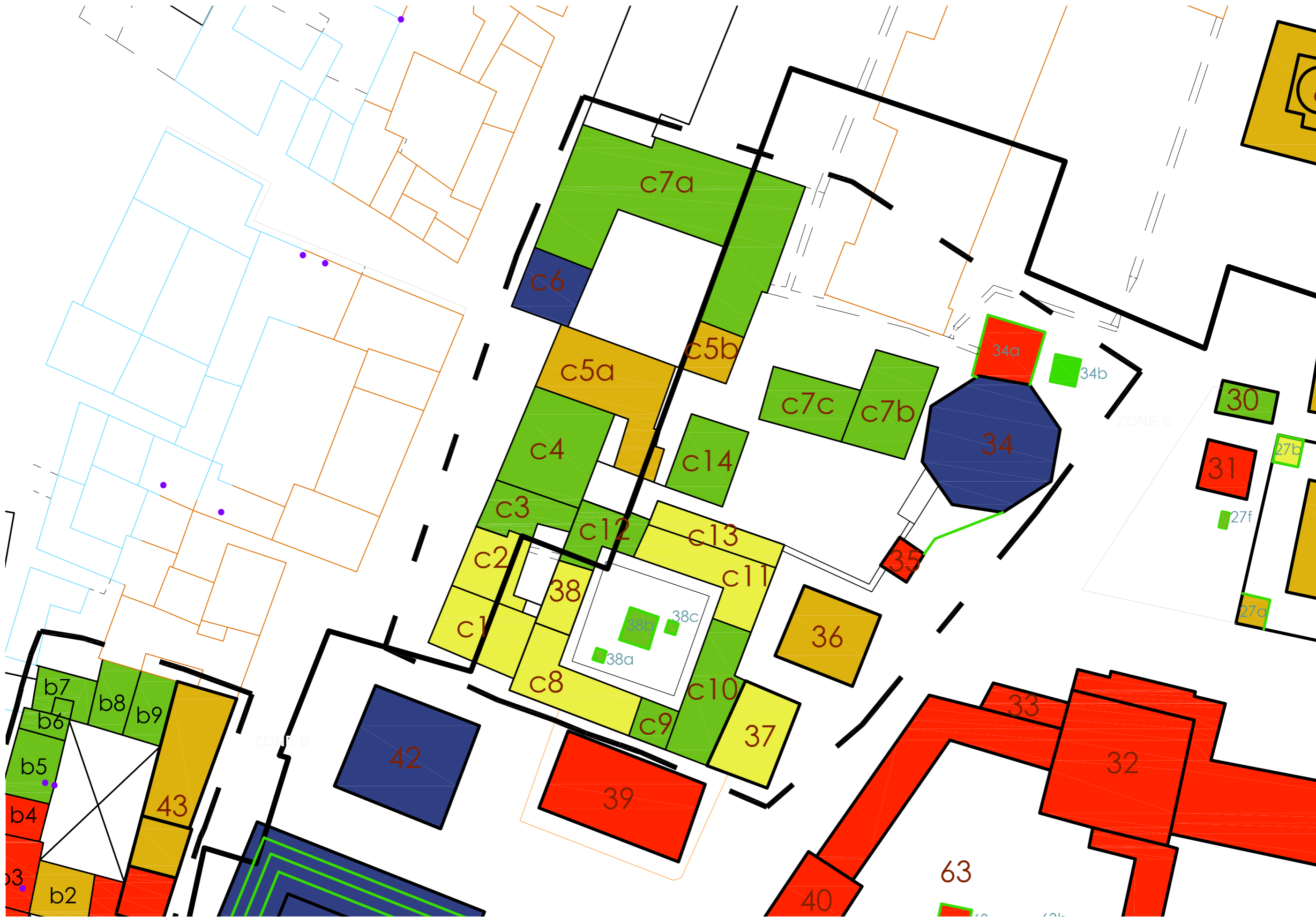

RESIDENTIAL BUILDINGS

ZONE C

c1



CODE NO.	OWNERS NAME/ CONTACT NO.	STOREY NO.	PRESENT STOREY NO	STRUCTURAL SYS- TEM	MATERIAL	GENERAL DESCRIPTION	PROBLEM DESCRIPTION	DANGER	HERITAGE SIGNIFICANCE	REMARKS
c01	Shree Krishna Shrestha	G+5/2EL	G+5	LB	B	CH	Vegetation growth at top floor			

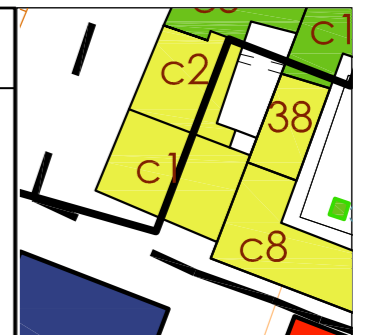

c2



CODE NO.	OWNERS NAME/ CONTACT NO.	STOREY NO.	PRESENT STOREY NO	STRUCTURAL SYS- TEM	MATERIAL	GENERAL DESCRIPTION	PROBLEM DESCRIPTION	DANGER	HERITAGE SIGNIFICANCE	REMARKS
c02	Shree Krishna Shrestha	G+4/2EL	G+4	LB	B	CH	Internal wall cracks			

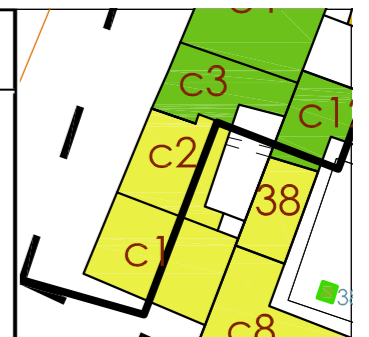

c3



CODE NO.	OWNERS NAME/ CONTACT NO.	STOREY NO.	PRESENT STOREY NO	STRUCTURAL SYS- TEM	MATERIAL	GENERAL DESCRIPTION	PROBLEM DESCRIPTION	DANGER	HERITAGE SIGNIFICANCE	REMARKS
c03	Sambhu Malla	G+4/2EL	G+4	LB	B		No visible damage			

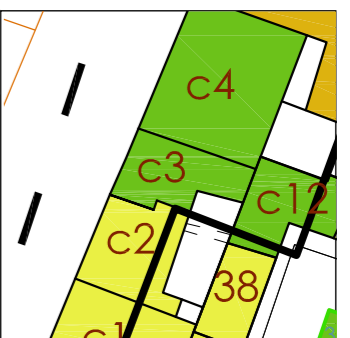

c4



CODE NO.	OWNERS NAME/ CONTACT NO.	STOREY NO.	PRESENT STOREY NO	STRUCTURAL SYS- TEM	MATERIAL	GENERAL DESCRIPTION	PROBLEM DESCRIPTION	DANGER	HERITAGE SIGNIFICANCE	REMARKS
c04	Binay Krishna Mathema (9841149328)	G+4/2EL	G+4	LB	B		No visible damage			

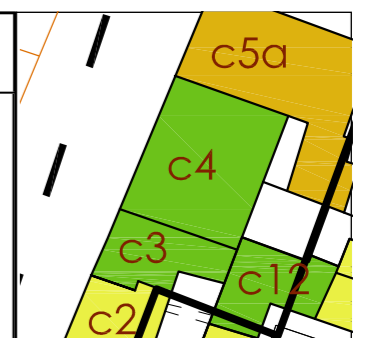

c5a, c5b



CODE NO.	OWNERS NAME/ CONTACT NO.	STOREY NO.	PRESENT STOREY NO	STRUCTURAL SYS- TEM	MATERIAL	GENERAL DESCRIPTION	PROBLEM DESCRIPTION	DANGER	HERITAGE SIGNIFICANCE	REMARKS
c05a	Gautam Manandhar	G+3	G+3	LB	B	EH	NE corner top part collapsed			
c05b	Gautam Manandhar	G+1	G+1	LB	B		Internal cracks			

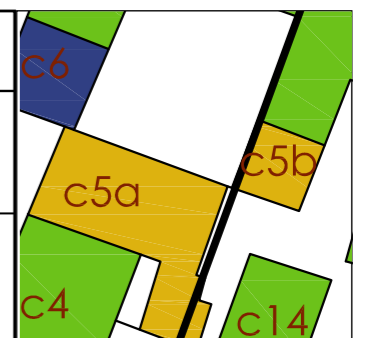

c6



CODE NO.	OWNERS NAME/ CONTACT NO.	STOREY NO.	PRESENT STOREY NO	STRUCTURAL SYS- TEM	MATERIAL	GENERAL DESCRIPTION	PROBLEM DESCRIPTION	DANGER	HERITAGE SIGNIFICANCE	REMARKS
c06	Gautam Manandhar	G+2		LB	B	CH	Totally collapsed			

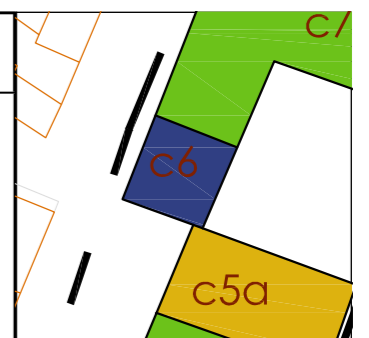

c7a

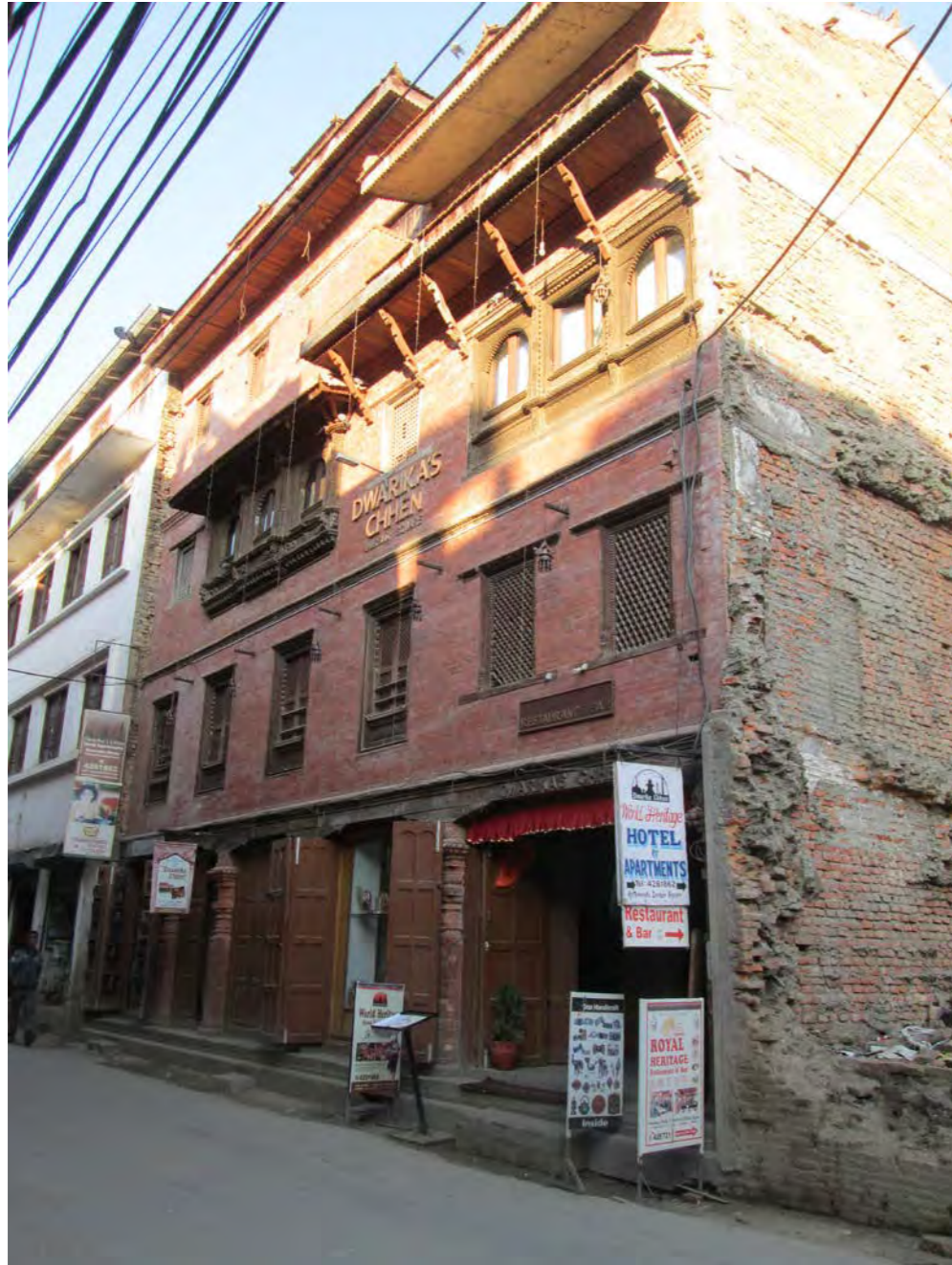

CODE NO.	OWNERS NAME/ CONTACT NO.	STOREY NO.	PRESENT STOREY NO	STRUCTURAL SYS- TEM	MATERIAL	GENERAL DESCRIPTION	PROBLEM DESCRIPTION	DANGER	HERITAGE SIGNIFICANCE	REMARKS
c07a	Dwarikas chein Sa- gal Manandhar (9851066000)	G+3.5	G+3.5	F	B+C	Hotel & Apartment	No visible damage			

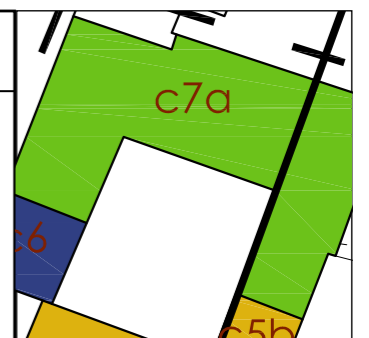

c7b, c7c



CODE NO.	OWNERS NAME/ CONTACT NO.	STOREY NO.	PRESENT STOREY NO	STRUCTURAL SYS- TEM	MATERIAL	GENERAL DESCRIPTION	PROBLEM DESCRIPTION	DANGER	HERITAGE SIGNIFICANCE	REMARKS
c07b	Sagal Manandhar (9851066000)	G+1	G+1	LB	B		No visible damage			
c07c	Sagal Manandhar (9851066000)	G	G				No visible damage			

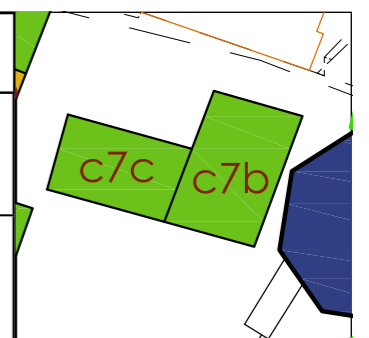

c8



CODE NO.	OWNERS NAME/ CONTACT NO.	STOREY NO.	PRESENT STOREY NO	STRUCTURAL SYS- TEM	MATERIAL	GENERAL DESCRIPTION	PROBLEM DESCRIPTION	DANGER	HERITAGE SIGNIFICANCE	REMARKS
c08	Gyan Man Bajracharya	G+3.5	G+3.5	LB	B+C		No visible damage from outside, internal hair line crack on wall			

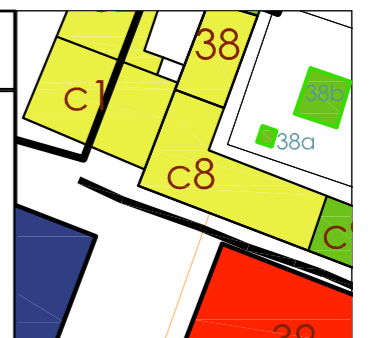

c9



CODE NO.	OWNERS NAME/ CONTACT NO.	STOREY NO.	PRESENT STOREY NO	STRUCTURAL SYS- TEM	MATERIAL	GENERAL DESCRIPTION	PROBLEM DESCRIPTION	DANGER	HERITAGE SIGNIFICANCE	REMARKS
c09	Krishna Man Bajracharya	G+3.5	G+3.5	F	B+C	cement plaster, glass window	No visible damage from outside, internal hair line crack on wall			

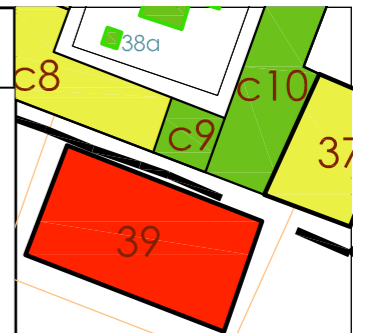

c10



CODE NO.	OWNERS NAME/ CONTACT NO.	STOREY NO.	PRESENT STOREY NO	STRUCTURAL SYS- TEM	MATERIAL	GENERAL DESCRIPTION	PROBLEM DESCRIPTION	DANGER	HERITAGE SIGNIFICANCE	REMARKS
c10	Rajendra Man Bajracha- rya	G+2.5	G+2.5	F	B	cement plaster, glass window	No visible damage from outside			

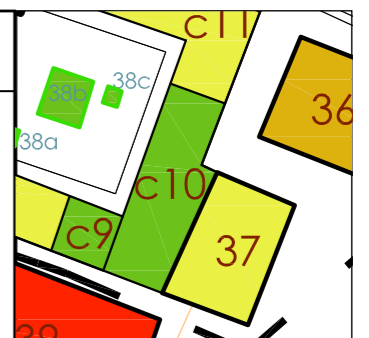

c11



CODE NO.	OWNERS NAME/ CONTACT NO.	STOREY NO.	PRESENT STOREY NO	STRUCTURAL SYS- TEM	MATERIAL	GENERAL DESCRIPTION	PROBLEM DESCRIPTION	DANGER	HERITAGE SIGNIFICANCE	REMARKS
c11	Dilli Man Bajracharya (9849411157)	G+2	G+2	LB	B+C	cement plaster	plaster cracks vertically, dampness rises			



c12



CODE NO.	OWNERS NAME/ CONTACT NO.	STOREY NO.	PRESENT STOREY NO	STRUCTURAL SYS- TEM	MATERIAL	GENERAL DESCRIPTION	PROBLEM DESCRIPTION	DANGER	HERITAGE SIGNIFICANCE	REMARKS
c12	Uday Man Bajracharya (4261242)	G+2	G+2	LB	B	cement plaster	No visible damage, hair line crack in internal wall			



c13



c14



CODE NO.	OWNERS NAME/ CONTACT NO.	STOREY NO.	PRESENT STOREY NO	STRUCTURAL SYS- TEM	MATERIAL	GENERAL DESCRIPTION	PROBLEM DESCRIPTION	DANGER	HERITAGE SIGNIFICANCE	REMARKS
c13		G+1	G+1	LB	B		Dampness rises, vegetation growth			
c14	Gautam Manandhar	G	G	F	B		No visible damage			





RESIDENTIAL BUILDINGS

ZONE D

d1

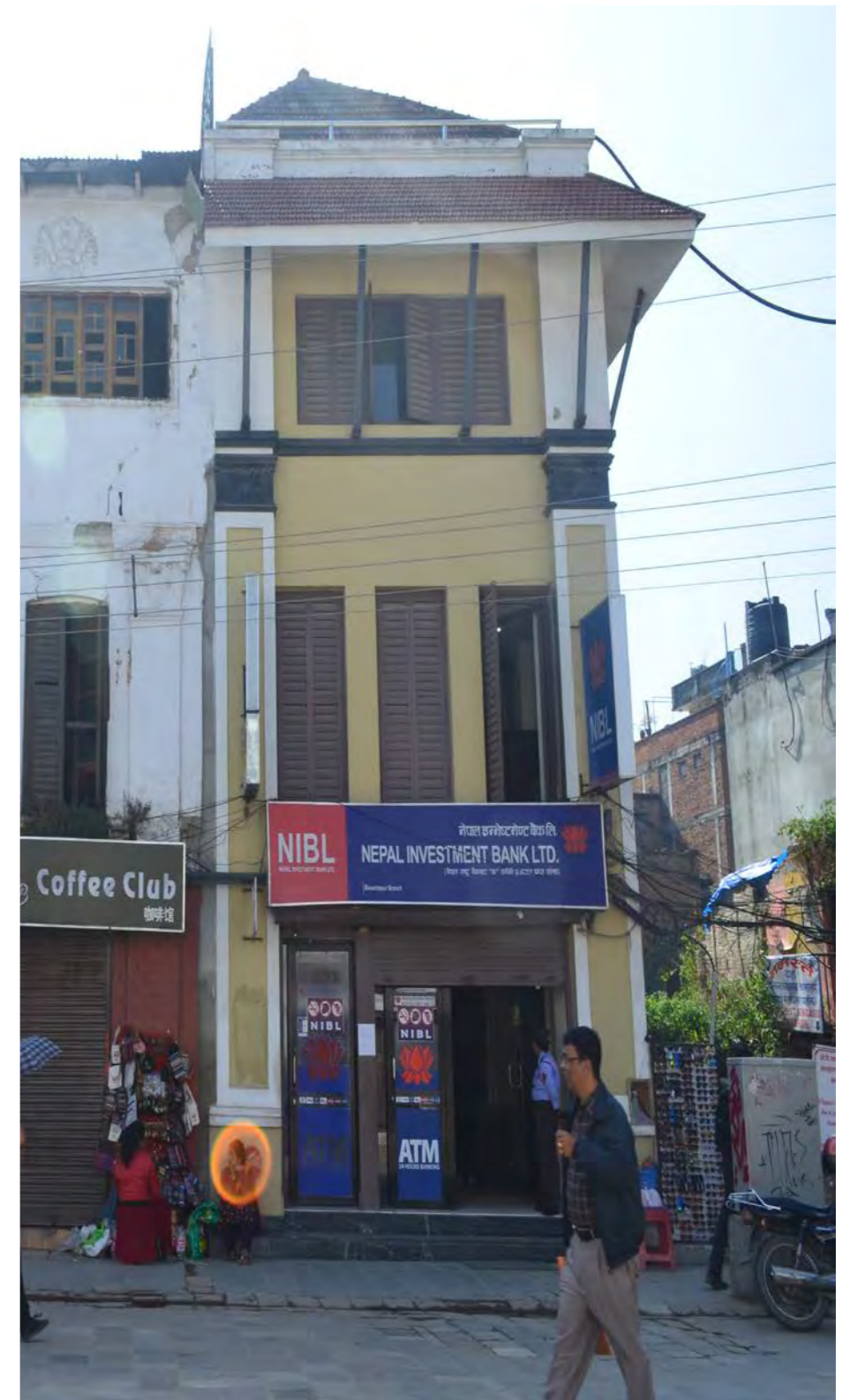

CODE NO	OWNERS NAME/ CONTACT	STOREY NUM- BER	PRESENT STO- REY NUMBER	STRUCTURAL SYSTEM	MATERIAL	GENERAL DESCEIPTION	PROBLEM DESCRIPTION	DANGER	Heritage Sig- nificance	REMARKS	
d01		G+3	G+3	Load Bearing	Brick	Cement Plastered with tiled roof	Minor cracks in top floor				

d2



CODE NO	OWNERS NAME/ CONTACT	STOREY NUM- BER	PRESENT STO- REY NUMBER	STRUCTURAL SYSTEM	MATERIAL	GENERAL DESCEIPTION	PROBLEM DESCRIPTION	DANGER	Heritage Sig- nificance	REMARKS
d02	Lab Dhoj Joshi	G+2	G+2	Load Bearing	Brick	Rana Style House with white housing	Extensive cracking on walls			



d3

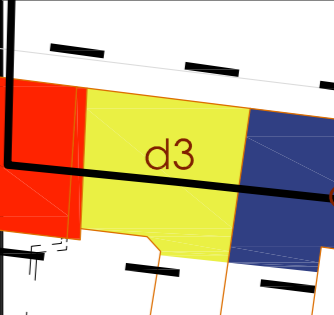

CODE NO	OWNERS NAME/ CONTACT	STOREY NUMBER	PRESENT STOREY NUMBER	STRUCTURAL SYSTEM	MATERIAL	GENERAL DESCRIPTION	PROBLEM DESCRIPTION	DANGER	Heritage Significance	REMARKS
d03	Govind Chipang	G+4	G+4	Load Bearing	Brick; Timber	Timber roof	Minor cracks			

d4



CODE NO	OWNERS NAME/ CONTACT	STOREY NUM- BER	PRESENT STO- REY NUMBER	STRUCTURAL SYSTEM	MATERIAL	GENERAL DESCEIPTION	PROBLEM DESCRIPTION	DANGER	Heritage Sig- nificance	REMARKS
d04		G+4	G	Load Bearing	Brick	Building being demolished be- cause of being too tall				

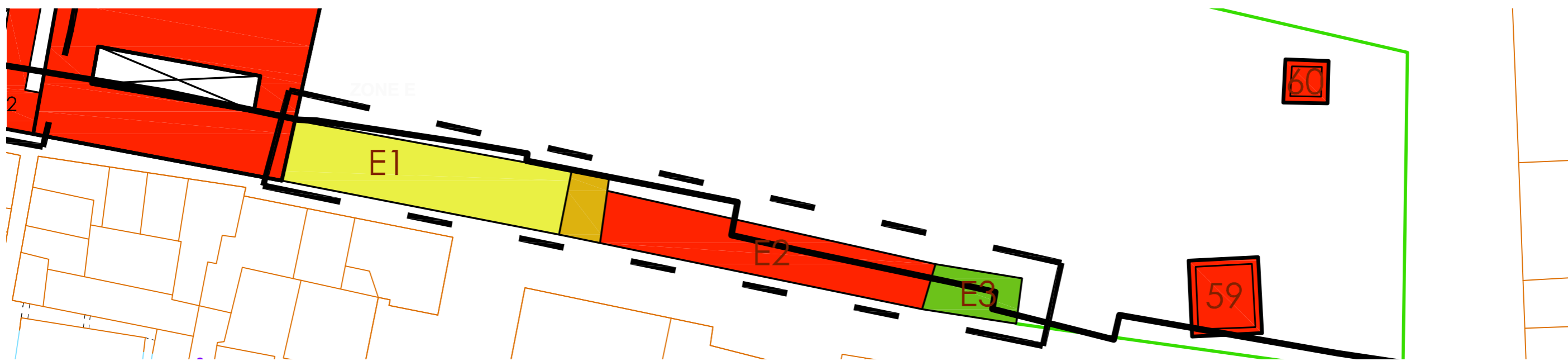
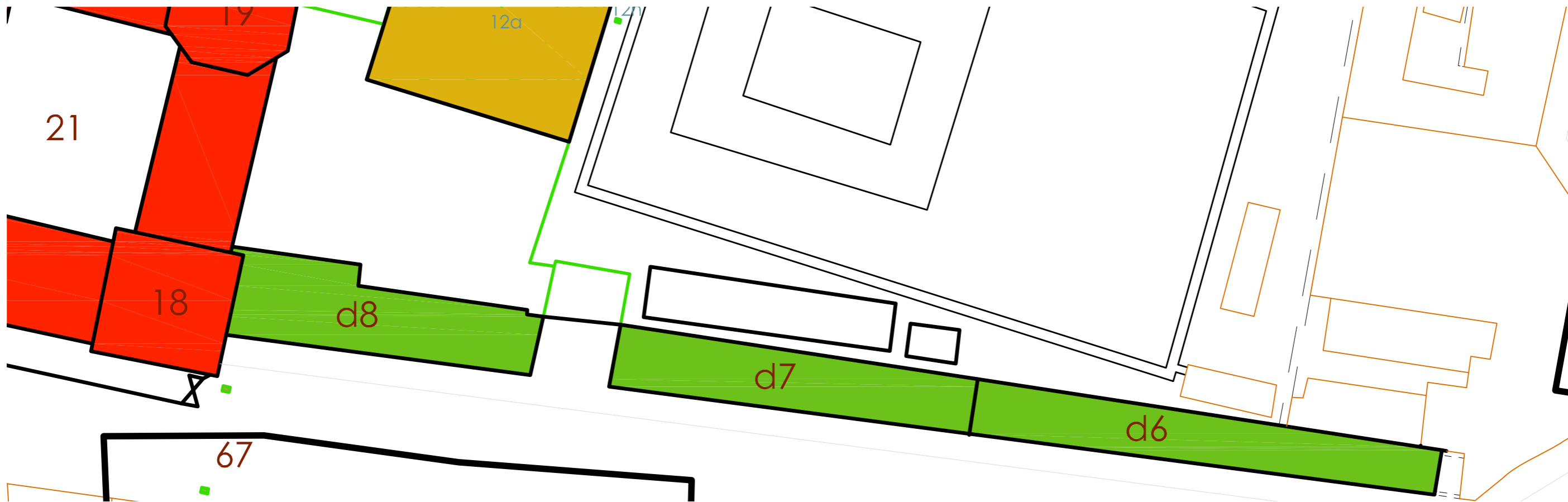

PUBLIC BUILDINGS

A3



CODE NO	TYPOLOGY	MONUMENT NAME	ESTABLISHED/RENOVATED DATE	STRUCTURAL SYSTEM	MATERIAL	GENERAL DESCRIPTION	PROBLEM DESCRIPTION	DANGER	REMARKS
a03	Community Building			Frame	Cement	Rcc Frame with brick cladding	No visible damage		

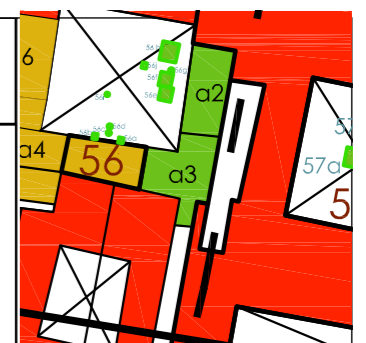

D5



CODE NO	TYPOLOGY	MONUMENT NAME	ESTABLISHED/RENOVATED DATE	STRUCTURAL SYSTEM	MATERIAL	GENERAL DESCRIPTION	PROBLEM DESCRIPTION	DANGER	REMARKS
d05		Damkal house		Load Bearing	Brick	Rana style house with white washing on outer façade	Extensive horizontal and diagonal cracks in walls. Northern corner collapsed.		

D6



CODE NO	TYPOLOGY	MONUMENT NAME	ESTABLISHED/ RENOVATED DATE	STRUCTURAL SYSTEM	MATERIAL	GENERAL DESCRIPTION	PROBLEM DESCRIPTION	DANGER	REMARKS	
d06				Load Bearing	Brick	Single storey structure used as shop	No visible damage			

D7



CODE NO	TYPOLOGY	MONUMENT NAME	ESTABLISHED/RENOVATED DATE	STRUCTURAL SYSTEM	MATERIAL	GENERAL DESCRIPTION	PROBLEM DESCRIPTION	DANGER	REMARKS
d07				Load Bearing	Brick	Single storey structure used as shop	No visible damage		



D8



CODE NO	TPOLOGY	MONUMENT NAME	ESTABLISHED/RENOVATED DATE	STRUCTURAL SYSTEM	MATERIAL	GENERAL DESCEIPTION	PROBLEM DESCRIPTION	DANGER	REMARKS	
d08				Load Bearing	Brick	Single storey structure with tiled roof and timber columns in front facade. Used as restroom.	No visible damage			

E1



CODE NO	TYPOLOGY	MONUMENT NAME	ESTABLISHED/RENOVATED DATE	STRUCTURAL SYSTEM	MATERIAL	GENERAL DESCRIPTION	PROBLEM DESCRIPTION	DANGER	REMARKS
e01	Community Building	Nava Adarsha High School	2025	Load Bearing	Brick	Ground floor used as office and upper floor used as school	Corner cracking and extensive cracking of walls of upper floors		

E2

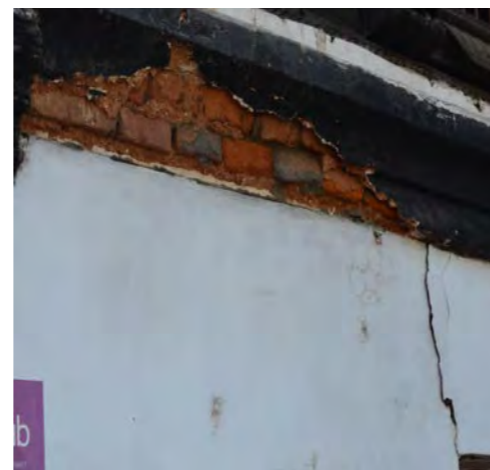
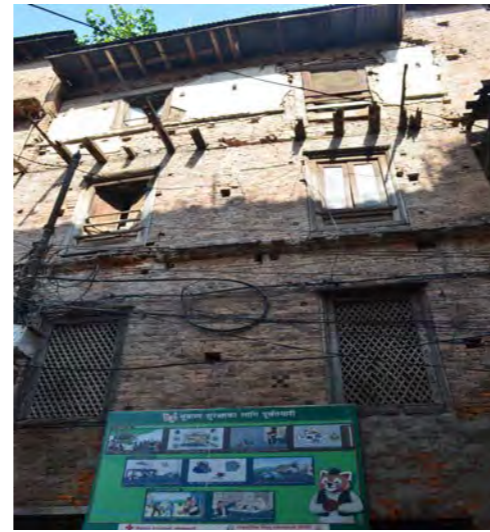

CODE NO	TYPOLOGY	MONUMENT NAME	ESTABLISHED/RENOVATED DATE	STRUCTURAL SYSTEM	MATERIAL	GENERAL DESCRIPTION	PROBLEM DESCRIPTION	DANGER	REMARKS
e02	Community Building	Nepal Sanskrit University		Load Bearing	Brick; Timber		Extensive cracking and bulging of walls; Ground floor walls delaminated and unstable		



E3



CODE NO	TPOLOGY	MONUMENT NAME	ESTABLISHED/ RENOVATED DATE	STRUCTURAL SYSTEM	MATERIAL	GENERAL DESCEIPTION	PROBLEM DESCRIPTION	DANGER	REMARKS
e03		Shina Swan Khala		Load Bearing	brick	Used as storage for chariot	Roof tiles Detached but overall structure is in good condition		

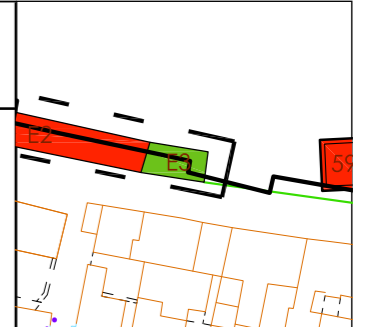



This document has been printed with support of the Government of Flanders to UNESCO.
2016\UNESCO