



United Nations
Educational, Scientific and
Cultural Organization



CRIHAP

International Training Centre
for Intangible Cultural Heritage in the Asia-Pacific Region
under the auspices of UNESCO



联合国教科文组织亚太地区非物质文化遗产国际培训中心

Workshop on Revitalization of Indigenous Architecture and Traditional Building Skills

In collaboration with the Government of Samoa
and the International Training Centre for
Intangible Cultural Heritage in the Asia-Pacific Region
under the auspices of UNESCO (CRIHAP)



Workshop on Revitalization of Indigenous Architecture and Traditional Building Skills

In collaboration with the Government of Samoa
and the International Training Centre for
Intangible Cultural Heritage in the Asia-Pacific Region
under the auspices of UNESCO (CRIHAP)



Published in 2015 by the United Nations Educational, Scientific and Cultural Organization
7, place de Fontenoy, 75352 Paris 07 SP, France

and

UNESCO Apia Office

© UNESCO 2015



This publication is available in Open Access under the Attribution-ShareAlike 3.0 IGO (CC-BY-SA 3.0 IGO) license (<http://creativecommons.org/licenses/by-sa/3.0/igo/>). By using the content of this publication, the users accept to be bound by the terms of use of the UNESCO Open Access Repository (<http://www.unesco.org/open-access/terms-use-ccbysa-en>).

The designations employed and the presentation of material throughout this publication do not imply the expression of any opinion whatsoever on the part of UNESCO concerning the legal status of any country, territory, city or area or of its authorities, or concerning the delimitation of its frontiers or boundaries. The ideas and opinions expressed in this publication are those of the authors; they are not necessarily those of UNESCO and do not commit the Organization.

Open Access is not applicable to non-UNESCO copyright photos in this publication.

Project Coordinator: Akatsuki Takahashi

Cover photo: *Fale* under construction at Samoa Culture Centre / © Akatsuki Takahashi

Graphic Designer: Warren Field

Contents

Acronyms IV

Summary of Consultation Proceedings 1

Annex I Opening Speeches 16

Annex II Presentations from Pacific Experts 20

Annex III Presentations from International Experts 51

Annex IV Outcomes Statement 110

Annex V Web Article 112

Annex VI General Information 113

Annex VII List of Participants 116

Annex VIII Workshop Programme 118



Acronyms

CRIHAP

International Training Centre for Intangible Cultural Heritage in the Asia-Pacific Region under the auspices of UNESCO

ICH

Intangible Cultural Heritage

MESC

Ministry of Environment, Sports, and Culture

MNRE

Ministry of Natural Resources and Environment

NUS

National University of Samoa

PIF

Pacific Island Forum

PUMA

Planning and Urban Management Act

TCH

Tangible Cultural Heritage

TVET

Technical and Vocational Education and Training

SHACRA

Safeguarding Heritage Community Research Approach

SPC

Secretariat of the Pacific Community

SPREP

Secretariat of the Pacific Regional Environment Programme

SQA

Samoa Qualification Authority

UNESCO

United Nations Educational, Scientific and Cultural Organization

USP

University of the South Pacific

WIPO

World Intellectual Property Organization

Summary of Consultation Proceedings

From 3 to 7 November 2014, heritage managers from Cook Islands, Fiji, Samoa, Tonga and New Zealand, as well as experts from China and Japan, participated in a workshop aimed at addressing the fragile state of the Pacific region's Intangible Cultural Heritage (ICH) with a primary focus on indigenous architecture and traditional building skills. The workshop was the result of the efforts of the Government of Samoa's Ministry of Education, Sports and Culture (MESC) and the International Training Centre for Intangible Cultural Heritage in the Asia-Pacific Region under the auspices of UNESCO (CRIHAP). Collaboration throughout this workshop was the first step in the Pacific region towards establishing a regional network and strategy for the safeguarding of indigenous architecture and traditional building skills. Through the sharing of country profiles, expert materials, and reflections in group discussions, the workshop set the groundwork for formalizing an action plan that can guide and inspire the different sub-regions of the Pacific in their efforts to revitalize a fragile form of ICH.





Day 1: Opening session

Day 1

The first day of the workshop began at the Samoa Tradition Resort with a morning session presided over by the CEO of Minister of Education, Sports and Culture (MESC), Matafeo Falana'ipupu Aiafi. The session began with a prayer delivered by Father Moseniolo Etuale, followed by opening remarks from the Chinese Ambassador, H Excellency LI Yanduan, and the Director of the UNESCO Office for the Pacific States Etienne Clement. This was followed by a keynote address given by the Minister of MESC Magele Mauiiu Magele. All the speakers' opening remarks expressed concern over the lack of protective measures to protect Pacific indigenous architecture and building skills; optimism over the intended outcomes of the workshop; and they expressed appreciation to the different sponsoring organizations for their support.

Following morning tea and a group photo, participants convened for a session of country reports. The presentations were given by representatives from the Cook Islands (Ngametua Pokino); Fiji (Mary Lavelave); New Zealand (Ellen Anderson Higgins); Samoa (Mata'afa Elia Autagavaia); and Tonga (Tapukitea Lolomana'ia). The country reports gave an in-depth overview of the current condition of traditional architecture in the Pacific region and the state of building skills in each respective country, as well as recommendations and goals for the future. The following is a summary of these presentations.



© Tiapapata Arts Centre

Day 1: Fale at Tiapapata Arts Centre

Ngametua Pokino – Cook Islands

Ngametua Pokino provided a case study focused on the island of Mangaia which demonstrated the dire condition of traditional building skills in the Cook Islands. This enlightening presentation revealed that only one church with its original interior remains and no indigenous *fale*-style architectures are left. Mr. Pokino told workshop delegates about his desire to spread knowledge and awareness about the traditional building skill of stone reinforcements as a way of providing cheap, durable homes for isolated, low-income communities across the Cook Islands.

Mere Velavela Dalituicama – Fiji

Mere Velavela Dalituicama gave an interesting presentation about the Fijian traditional building, the *bure*. This talk revealed that Navala is the only village in Fiji in which traditional homes remain. Workshop delegates were told the country is facing a loss of building skills due to factors such as negligence and globalization. However, steps are in place to institutionalize the preservation of traditional architecture through measures such as continued documentation, education, environmental protection schemes, building code adaptation, and legal frameworks for *bures*.

Ellen Anderson Higgins – New Zealand

Ellen Anderson Higgins from Heritage New Zealand gave an in-depth presentation of how to successfully use expertise, local communities, local materials and legal frameworks to revitalize buildings with cultural sensitivity and long-term protection. Ms. Higgins' detailed presentation emphasized that traditional homes must be celebrated to garner support for their protection and



© UNESCO/A. Takahashi

Day 1: Mr Tevita, Director of Samoa Culture Centre

preservation, e.g. through education. She also stressed that incentives for retaining knowledge and buildings must be provided, e.g. through formal funds.

Mata'afa Elia Autagavaia – Samoa

Mata'afa Elia Autagavaia from the Samoan Ministry of Environment, Sports, and Culture (MESC) provided an overview about the building process; from the family's request for a *tufuga*, or master builder; to traditions associated with the differing stages of construction. This interesting presentation illustrated the cultural aspect of architecture and how the preservation of these skills can help revitalize languages, the understanding of past cultures and social hierarchy, and the protection of natural resources.

Tapukitea Lolomana'ia – Tonga

Tapukitea Lolomana'ia's presentation gave a deep overview about the state of the *fale* Tonga – a traditional thatched house, built with local construction materials. The use of the *fale* is diminishing and the skills to build this type of property may soon be lost as the older generation passes on and younger community members fail to learn traditional building skills. However, information about the *fale* has been documented so that this form of architecture can be preserved for future generations. A primary feature of the Tongan *fale* system is its strong relation to a social hierarchy of a king, chiefs, and commoners. The objective in Tonga is to establish a *fale* in every village so they will remain as a strong symbol of the island's rich cultural heritage for future generations.



© UNESCO/A.Takahashi

Day 2: Fale under construction

After these insightful presentations, participants took part in a guided tour around Apia and existing physical structures inspired by the *fale* Samoa were pointed out to the group. This tour helped participants better understand the current preservation status of the *fale* Samoa and the contemporary use of traditional architectural styles. The bus tour took in government buildings along Apia's shorefront, the Matai'a village of Vaimoso, and the Samoa Tourism Authority's *Fale*. Additionally, participants were given a guided tour of the National Museum of Samoa. To conclude the trip, participants visited the Tiapapata Art Centre and met with Galumalemana Steve and Wendy Percival who both run the centre. Participants were shown the recently constructed traditional meeting *fale*, or *faletalimalo*, and discussed its construction over *Koko Samoa* drinks.

Day 2

The second day of the workshop focused on the specific design and structural components of Samoan architecture and how this form relates to the structure's function and disaster resiliency, as well as the society's social structure. Presentations were given by career educator Maulolo Tavita Amosa and Anne Milbank of UNDP. The concepts of their presentations were later illustrated throughout the activities in the afternoon. The following are summaries of these presentations.

Maulolo Tavita – Samoa Culture Centre

The presentation delivered by Maulolo Tavita, CEO of the Samoa Culture Centre, summarized the connection between form and function in the design of the *fale*. The evolution of Samoa's



Day 2: Participants

traditional buildings relates to the different needs of the community, workshop participants were told. For example, the *fale* that stores the canoe cannot be constructed with a middle post and does not need covered sides as in the type of construction built for human habitation. Additionally, the talk revealed that the spatial arrangement of people during meetings within the *fale* can reveal their social hierarchy.

Anne Milbank – UNDP

Anne Milbank of UNDP in Samoa explained in her presentation that Samoan building tradition has a rich history that has been documented but is not commonly practiced in modern times, despite the architectural resilience of the design, for example the form of the cantilever post and traditional lashing technique. Ms. Milbank's presentation highlighted the need for Samoa to develop its forestry industry to provide raw materials for use in the construction of traditional and affordable homes. She also said that building standards need to take into account traditional architecture. The presentation included a summary about the Cyclone Evan Reconstruction Project which provided support for the construction of *fales* for domestic use after Cyclone Evan left a trail of destruction in December 2012.

Following a morning break at the Samoa Tradition Resort, participants were able to visualize concepts discussed in the morning session from personal accounts about traditional building given by Samoan *fale* builders from the island of Savai'i, Loli Tuisavalalo and Maulupe Faatali. Participants were then taken through a detailed, step-by-step description of the entire building



Day 2: Workshop session

process, from the official family request for a *fale*, to the celebration of its completion. Additionally, a fascinating description about the taboos and spiritual practices associated with construction was provided. Personal stories and understanding shared by Samoan master builders inspired the need to safeguard this culture and highlighted how a modern context of resilience development can incorporate and revitalize these skills. It was recommended that help be provided to *tufuga* to break down technical building code language to traditional builders so they can work with, and recommend changes to the existing frameworks.

Participants were then shown a video entitled “*Exploring the use of Samoan Coconut Sennit*” which illustrated the production of sennit – the coconut fibre used for lashing in traditional crafts and buildings known generally as *afa*. The video also included clips that demonstrated the construction of the traditional *fale* at the Tiapapata Arts Centre. To further illustrate the technical architectural points made in the morning, participants were taken to the Samoa Culture Centre where a *fale* was built over the course of the five-day workshop. After having the opportunity to view the *fale* and ask the builders questions, the group had a break for lunch which was provided by the Samoa Culture Centre.

In the afternoon, participants met in small groups for their first group discussion on: “What elements of house building need to be safeguarded?” Representatives of each small group then presented their findings in front of all the participants. Elements of house building fall into both intangible and tangible categories. Intangible elements involve the skills needed in all the processes of house building – from the selection of materials, to the processing and finally to

the construction stages. It was highlighted that there are also cultural traditions associated with house building that should be protected and revitalized. Tangible elements include protection of raw materials, preservation of models of different *fale* types and continued use of traditional building tools. The presentation of group discussion points concluded the agenda for the day.

The following is a table of the specific conclusions shared by participants from the group discussion:

Discussion 1: *What elements of house building needs to be safeguarded?*

Intangible	Tangible
<ul style="list-style-type: none"> • Ability to select the proper raw materials, i.e. spot the best materials and know the correct ones; • Processing material skills, e.g. sinnet; • Ability to design <i>fales</i>, and thus adapt to new functions or make them exciting to modern builders; • Skills in construction of the <i>fale</i>, e.g. lasing, weaving, thatching, jointing; • Recognizing or remembering cultural protocols and reasons, e.g. spirits, mana, taboos, celebrations like <i>fa'aulufuega</i> and <i>umusaga</i>; • Languages; • <i>Tufuga</i> skills and knowledge, e.g. not just how to build – but to be a master and to pass on knowledge. 	<ul style="list-style-type: none"> • Protect raw materials, e.g. <i>ulu, poumuli, maniuniu, niuvao, tolo fua lau, niu afa, asi</i>, etc.; • Preserve the different types of <i>fales</i>, e.g. as models; • Maintain traditional building tools.

Day 3

On the third day of the workshop at the Samoa Tradition Resort, Nittoh Kazuhiko, an architectural expert from Japan, opened the morning session to a broader global perspective with case studies about various traditional homes. Similarly, Akatsuki Takahashi of the UNESCO Office for the Pacific States gave a presentation on an international framework for safeguarding heritage such as knowledge and skills related to indigenous architecture through the Intangible Cultural Heritage (ICH) Convention. The following is a summary of these presentations.

Nittoh Kazuhiko – Conservator in Japan

Nittoh Kazuhiko presented a comprehensive overview of thatching styles and uses throughout the world and cited examples in use in Japan in contemporary times. Analysis of Japanese practices surrounding traditional buildings revealed a culture of regular maintenance and community participation. The presentation confirmed that Samoa can move forward confidently towards the revitalization of traditional house building skills, with the added knowledge that the international community supports and values these traditional styles.



Day 3: Discussion at Fale at Samoa Culture Centre

Akatsuki Takahashi – UNESCO Office for the Pacific States

Akatsuki Takahashi from the UNESCO Office in Apia gave an overview of the ICH Convention and its international cooperation mechanisms for safeguarding ICH, including the ICH Representative List, the ICH Urgent Safeguarding List, and the Register of Best Safeguarding Practices. Eight Pacific state parties have already engaged in the implementation of the ICH Convention in the region.

Following the morning's presentations, participants divided into smaller groups to begin their second group discussion on: "The advantages and disadvantages of traditional buildings." Before presenting their conclusions, the group was transported to the Samoa Culture Centre to have lunch and observe the progress of the *fale* construction. Participants then presented a number of both advantages and disadvantages to traditional house building practices, including some factors that can appear on both lists. For example, the time consuming nature of the process can both elevate the value of the house to a work of art but also dissuade customers who want a quickly constructed home from choosing a traditional style. It was acknowledged that there seemed to be a gap between what participants agreed would be aesthetically pleasing and what is actually achievable. That is, it would be preferable for people to widely use traditional homes as they are known to be sustainable and to preserve culture, but the average family may find it difficult to live out a modern lifestyle in such a traditional home. However, emphasis should be on moving forward to protect what can be safeguarded and let the specifics of the type of *fale* and its appropriate legal frameworks to evolve with time. To initiate this process, the *tufuga* need to be better represented; the status of the *fale* and the *tufuga* elevated (though the *tufuga* may need to accept compromises as their place in modern culture has changed); and new building codes and regulations adopted for traditional building. This discussion concluded the agenda for the day.

The following table shows the specific conclusions shared by participants from the group discussion.

Discussion 2: *What are the advantages and disadvantages of having traditional buildings?*

	Advantage	Disadvantage
Tangible	<ul style="list-style-type: none"> • Sustainable materials; • Traditional tools are more accurate; • <i>Fales</i> are suitable for the local climate; • Resilient to natural hazards 	<ul style="list-style-type: none"> • Labour intensive. • Regular maintenance required because traditional materials are not as durable; • Untreated materials; • The design of the house has health issues, e.g. toilet and kitchen in the same place; • Improper building of <i>fale</i>, or ill-advised traditional-western adaptation would actually weaken resistance to natural hazard threats; • Fire risk; • Architecture makes repairs difficult, e.g. removing the rotted central post is difficult; • The need to fumigate; • Lack of building records available from old times in some cases.
Intangible	<ul style="list-style-type: none"> • Build knowledge of culture, e.g. language, building skills; • Increased use of hand tools; • Promote national identity and culture because unique to each nation; • Lower cost if local materials are available; • Less dependence on foreign materials; • Economic incentives, e.g. increase tourism; • Enhance sense of community, e.g. helping each other build homes, holding traditional celebrations; • Room for innovations; • Alternative career pathway, e.g. for those can't afford school fees or don't have a formal education; • Support the educational system, e.g. provide another activity for students, a way for students to engage in learning about traditional culture, and a way to pass on values like patience; • The time and skill needed to create <i>fale</i> elevates it to an artisan craft; • Impetus for forming associations between <i>tufuga</i>. 	<ul style="list-style-type: none"> • Lack of building codes and regulations; • More expensive for places lacking natural resources; • Lack of privacy and safety, e.g. from robberies; • Low number of <i>tufuga</i> left which leads to the following issues: • Difficulties in identifying builders; • Difficulties in creating strong representation; • Difficulties in perpetuating skills; • <i>Tufuga</i> reluctant to share skills; • Understanding and formalizing <i>tufuga's</i> desired form of compensation; • Skills copied by foreigners or others, i.e. a lack of intellectual property protection; • Incongruent to modern living; • Youth uninterested in building skills or building styles; • Contract work outcompeting <i>tufuga</i>; • Building skills becoming a commodity not an art and something of high value.



© UNESCO/A. Takahashi

Day 3: Fale under construction at Samoa Culture Centre

Day 4

The fourth day of the workshop began with presentations from representatives of the sponsoring international training centre, CRIHAP. Deputy Director-General Zhang Jing gave a presentation about the function and missions of CRIHAP and on the *“Protection of ICH in China.”* As Chinese architectural experts Zhao Di and Zhang Xin-An were unable to attend the workshop, Tang Haijiao of CRIHAP went through their respective presentations on *“An Introduction to Chinese Traditional Architecture”* and *“An Introduction of the Safeguarding of Chinese Traditional Architectural Craftsmanship for Timber-framed Structures”*. The following is a summary of these presentations.

ZHANG Jing – CRIHAP

ZHANG Jing gave a presentation that provided enlightening information to the workshop on CRIHAP, an organization that is not legally part of UNESCO but is associated with the UN agency through a formal arrangement due to their specialization in one of UNESCO’s key fields. He explained that there were eight category two centres that specialize in ICH in the world, and that CRIHAP has a focus on capacity building in ICH safeguarding with an integrated approach. He added that China served as an example of how to formalize safeguarding measures through legislation, research and protection centres, documentation, festivals and exhibitions, resource materials such as manuals, archives/databases, and the ICH Convention which promotes an integrated safeguarding concept.

ZHAO Di – Chinese National Academy of Arts

Zhao Di from the Chinese National Academy of Arts gave an interesting presentation that focused on Chinese traditional timber-framed architecture. This presentation gave a deep insight into important elements of Chinese architecture, including the timber frame, three-segment composition and modular design. This presentation highlighted some solid projects for the preservation of timber-framed architecturally rich buildings in China and it also emphasized the need to have specific and targeted strategies in heritage preservation approaches in order to meet different circumstances that exist in protection measures.

ZHANG Xin-An – Chinese National Academy of Arts

The presentation of Zhang Xin-An, from the Institute of Architectural Art, at the Chinese National Academy of Arts, was made under the topic: “*An Introduction of the Safeguarding of Chinese Traditional Architectural Craftsmanship for Timber-framed Structures*”. This presentation emphasized the need to engage multimedia to document and explain building techniques. It also highlighted the necessity to acknowledge the value of traditional building skills to successfully integrate that understanding into the common culture, for example, the practice of holding celebrations when an apprentice begins learning from a master builder, and showcasing traditional building models to children through engaging exhibitions.

Following a morning break at the Samoa Tradition Resort, the group reconvened for a presentation from John Sitaga and Su’a P. Onosema of the Planning and Urban Management Agency (PUMA) Division of the Ministry of Natural Resources and Environment (MNRE) to learn how this agency deals with traditional buildings, plus its future aims. The following is a summary of the presentation.

Su’a P. Onosema and John Sitaga – Planning Urban Management Agency (PUMA) Division of MNRE

Workshop participants were informed about PUMA’s work and they were told how one of PUMA’s key directives is to establish a framework that integrates itself into the commonly practiced building process in Samoa. The presentation highlighted how traditional architecture is encompassed in the agency’s goals for diversified development and balancing the present and future needs of Samoa, particularly by the Apia Spatial Plan 2014. Mr. Onosema said that although small-scale *faleo’o* buildings are recognized and exempt from development consent, PUMA is still working to expand its coverage of traditional architecture more explicitly and robustly.

After the presentation, participants were transported to the Samoa Culture Centre for lunch and a follow-up on the construction of the traditional *fale*.

The last activities of the day were two related discussions:

1. “How to revitalize our traditional building skills?”
2. “What are the participants’ recommendations moving forward?”

Both discussions produced similar recommendations which were directed at national governments, the private sector, regional agencies, CRHIAP, and UNESCO. See Annex IV for the exact Outcomes Statement that resulted from these discussions. Most recommendations fall into the following five general categories.

1. Education/Training

It was recommended that the value of indigenous architecture and traditional skills be emphasized more heavily in primary, secondary and tertiary education, particularly the disaster-resilient design of traditional structures and their applicability to modern architecture. Additionally, vocational schools offering alternative pathways for students can expand programmes that train traditional builders. To this end, TVET and qualification authorities (such as Samoa QA) must strengthen certification programmes for *tufuga* to equip them to train interested students and to advance their own skills.

2. Media/Visibility

To raise the appeal of constructing indigenous architecture and to attract student builders, the media must provide enhanced coverage of new initiatives and success stories, as well as coverage of the disaster-resilient nature of traditional structures. Promotion of certification programmes or *tufuga*-devoted government bodies could raise the status of traditional buildings and its associated career pathway, thus attracting more people. Additionally, celebrations traditionally practiced with the construction of traditional buildings, if revitalized, should be promoted through the media.

3. Documentation/Archives

Safeguarding would be enhanced through the documentation of remaining traditional buildings and skills, such as through the creation of a manual booklet, maps, and national and regional archives and databases. Additionally, these materials would be useful to the areas of education, media, institutionalization and the establishment of legal frameworks and plans by providing relevant materials and supporting their proposals. Furthermore, a list of relevant consultants and experts can be compiled.

4. Institutionalization

The establishment of centres or associations to act in the interest of the *tufuga* will improve implementation of new initiatives and complement government efforts. These bodies can include research and training centres, and will most importantly include a master builder association that can provide a unified voice for *tufuga* in their dealings with the public and the private sector.

5. Legal Frameworks/National and Regional Plans

Governments are traditionally looked upon to initiate and fund the aforementioned initiatives. With this approach in mind, it was recommended that governments and regional agencies create strategies for the environmental protection of necessary building raw materials and replanting schemes, village consultations, the expansion of building code frameworks to address different traditional structures, and the protection of intellectual property.

Day 5

The last day of the workshop began at the Samoa Tradition Resort with a presentation by Lea Lani Kauvaka of the University of the South Pacific (USP). Ms. Kauvaka discussed her current research into safeguarding heritage, which emphasizes housing sovereignty, which is the right for everyone to be self-sufficient in making their own house if desired. The following is a summary of the presentation.



Day 5: Participants

Lea Lani Kauvaka – USP

Lea Lani Kauvaka gave a presentation on the Safeguarding Heritage Community Research Approach (SHACRA) developed by her research group at USP. SHACRA aims to strengthen regional connections and linkages across all sectors in order to safeguard heritage across the Pacific region. The research builds inventories and safeguarding capacity and will creatively disseminate this information through forms such as art contests and public performances. The key concept of housing sovereignty is the right of everyone to have access to shelter, affordable materials, and training on how to make houses if they desire to be self-sufficient. Ongoing research is carried out in Ha'apai, Tonga, where innovative building methods are being explored, such as bamboo construction, recycled items and earth materials.

Following a morning break, a press conference was held to convey the purpose of the workshop to the media and what outcomes had been achieved. Workshop representatives Loli Tuisavalalo, Ellen Anderson Higgins, Tapukitea Lolomana'ia, Mary Lavelave and Ngametua Pokino addressed representatives of the press. Following their presentation of the Outcomes Statement, Director of the UNESCO Office for the Pacific States Etienne Clement and Deputy Director-General from CRIHAP Zhang Jing gave their concluding thoughts and answered questions from the media.

Participants were then transported to the Samoa Culture Centre for a final lunch and to see the thatching go up on the nearly completed *fale*. They were then awarded their certificates for completing the workshop and these were presented by Director of the UNESCO Office for the Pacific States Etienne Clement and Deputy Director-General of CRIHAP Zhang Jing.

Summary of Consultation Proceedings



© UNESCO/A. Takahashi

Day 5: Fale under construction and group photo (below)



© UNESCO/A. Takahashi

Annex 1

Opening Speeches

LI Yanduan

Chinese Ambassador, Apia

Opening Remarks

Dear Friends, Distinguished Guests, Ladies and Gentlemen,

I'm very happy to be invited to the Opening Ceremony of the "Workshop on the Revitalization of Indigenous Architecture and Sustainable Building Skills in the Pacific". As we know, the workshop is the specialized training for building the capacity of government officials, intangible cultural heritage custodians and practitioners, researchers and NGOs in the Pacific for safeguarding the traditional indigenous architectures such as the Samoan *Fale* and the Fijian *Bure* and revitalizing the knowledge and skills concerned. We do support and appreciate the great efforts made by the Ministry of Education, Sports and Culture of Samoa and CRIHAP in China (International Training Centre for intangible Cultural Heritage in the Asia and Pacific region) to provide the present platform to explore cultural policies, challenges and opportunities for the safeguarding of the intangible cultural heritage for the well-being of communities.

We are pleased to welcome the participants from Asia and-Pacific, including the experts long away from China. As you know China has 56 ethnic groups which have diversified colourful cultures. And the great Chinese culture is with the rich ethnic or indigenous contents. China has done the tremendous work to protect the cultures of our ethnic groups. I am sure that the experts from China will share the experiences in the protecting the indigenous architecture in China and make their own contributions to the workshop.

At the end, I'd like once again to say, welcome to beautiful Samoa. I'm sure during the stay here all the guests not only will harvest good results from the workshop but also will enjoy the rich culture, warm hospitality of Samoan people, and the charming scenery of the Pacific islands. I wish the great success of the workshop.

Thank you.

Etienne Clement

Director, UNESCO Office for the Pacific States

Opening Remarks

I am honoured and pleased to be here at the opening session of the “Workshop on the Revitalisation of Indigenous Architecture and Sustainable Building Skills in the Pacific”. On behalf of UNESCO, I would like to thank the Samoan authorities for hosting this workshop and congratulate the International Training Centre for Intangible Cultural Heritage in the Asia-Pacific Region under the auspices of UNESCO (CRIHAP) for this important initiative, and I would also like to extend my warm welcome to the participants coming from other Pacific island nations as well as the distinguished experts in the cultural heritage preservation from China, Japan, Samoa and from UNDP.

This five-day workshop will address challenges and opportunities for the revitalization of indigenous architectures, as well as the knowledge and skills that are necessary for their construction. This event demonstrates that Tangible Cultural Heritage (TCH) and Intangible Cultural Heritage (ICH) are in fact inseparable from one another. Our heritage, in all its dimensions, is a reservoir of ancestors’ knowledge and wisdom, providing a foundation for our identity and sustainable development.

The traditional meeting houses in the Pacific have been a centre for village governance and a place for community life. A broad range of knowledge and skills are needed to construct these unique architectures, ranging from sennit production to rafter making, lashing and thatching. These indigenous architectures also demonstrate adaptations and resilience to environmental hazards. As we see here in Samoa, tourists and visitors often prefer staying at beach *fale* done in the traditional style and cottages with thatched roofs. In the Pacific, the builders of houses belonged to an ancient guild of master builders. The Samoan word “*Tufuga*” denotes the status of master craftspeople.

The indigenous architectures of important cultural and socio-economic significance in the Pacific have been rapidly disappearing due to the lack of understanding of their value in our modern world. Additionally, there has been a lack of resources that would enable government and civil society to take concerted actions for the preservation and transmission of this important heritage.

This was the motivation behind UNESCO Apia’s publication called “*The Samoan Fale*” some 20 years ago which documented the traditional knowledge and skills necessary to construct indigenous architectures and their roles at Samoan villages.

Nowadays, one can still appreciate the authentic landscape of traditional Samoan villages in the protected areas such as Fagaloa – Uafato Bay, which is, in fact, on the Tentative List of Samoa for World Heritage nomination. But, the building skills are perpetuated only by a small number of master builders and craftspeople. The Samoan *fale* and its building skills are in need of urgent safeguarding and many other Pacific islands nations are facing the same challenges.

In 2003, UNESCO adopted the UNESCO Convention for the Safeguarding of the Intangible Cultural Heritage. This was a response to the growing concern over the adverse impact of globalization on communities' cultures and traditions. Since its adoption in 2003, over 150 countries are now parties to this ICH Convention, including eight Pacific islands countries (PNG, Fiji, Tonga, Vanuatu, Palau, Nauru, Micronesia and Samoa). The Convention not only contributes to the ICH safeguarding, but also highlights ICH's contribution to the development and well-being of communities. Now that eight Pacific countries are parties to the ICH Convention, there is a very real possibility of strengthening the safeguarding of the Pacific ICH both at national and regional levels through mechanisms such as the ICH Representative List and the ICH Urgent Safeguarding List. It is hoped that this workshop will discuss how the Pacific states parties can effectively implement the ICH Convention in order to revitalize the indigenous architectures and their associated ICH in the Pacific.

Before concluding, I would like to acknowledge the excellent preparatory work done by the Culture Division of MESC and CRIHAP staff. My special thanks also go to the Tiapapata Arts Centre, the Samoa Culture Centre and, last not but least, Raofale, master builder of the Samoan *fale*, who has generously accepted to share his enormous knowledge and experience with the participants of this workshop. Without their hard work and dedication, we would not be able to assemble here today.

Thank you again and I wish you every success in your work.

Magele Mauiliu Magele

Minister of Education, Sports and Culture

Keynote Address

It is indeed a great pleasure for me to open this *"Regional Workshop on the Revitalization of Indigenous Architecture and Sustainable Building Skills in Samoa"*.

We are in a very critical age battling global threats, both man-made and natural, that threaten the survival of our cultures and ways of life, especially small island states like us in the Pacific.

We have in our generation survived more cyclones, floods, tsunamis and earthquakes than any of our forefathers and generations before us. This to me is a reason enough to act now.

Research seems to show that our traditional architecture are more resilient to the threats of climate change than our more modern homes we seem to prefer in this day and age.

This week I hope for open dialogue with you all – traditional master builders, researchers, preservation experts, engineers, custodians of traditional building skills, chiefs and orators, technical and related services. Let's talk on how we can safeguard our traditional building skills and architecture in Samoa and the Pacific and why this is a necessity for the promotion of our culture and way of life.

Annex I Opening Speeches

The aim of this workshop is to know the importance of safeguarding our cultural heritage and find ways to revive and ensure the passing of traditional skills associated with this fading art from our generation to the next.

The outcome after this week is hopefully a framework we can all claim ownership of, where practitioners and researchers and government and our development partners can collaborate, to revive and better safeguard the transmission of indigenous architecture and building skills in the Pacific region and the authentic *fale* Samoa.

I would like to thank the hosts for our workshop, the Tradition Resort for your warm welcome and the Samoa Culture Centre thank you Maulolo for kindly assisting us by offering to be the venue for the practical demonstration of how to build the traditional Samoan *fale*.

I understand activities this week will not only include presentations from experts in the field of architecture both modern and traditional, but also shared dialogue, a field trip, a museum exhibition, a practical demonstration of building a Samoan *fale* and a *fiafia* night.

I would like to acknowledge and express our sincere thanks to CRIHAP from China and UNESCO for the financial assistance that has made this workshop possible. Your kind assistance has given a great opportunity to the Pacific region and Samoa to bring together their experts to share their knowledge and skills in reviving the art of indigenous architecture of house building.

And on that note, wishing you all a successful week and I declare this workshop officially open.

Soifua!

Fale at Tiapapata Arts Centre



Annex II

Presentations from Pacific Experts

1. **Ngametua Pokino** – Cook Islands (PowerPoint)
2. **Mere Velavela Dalituicama** – Fiji (PowerPoint)
3. **Ellen Anderson Higgins** – NZ (PowerPoint 1 and PowerPoint 2)
4. **MNRE/PUMA** – Samoa (PowerPoint)
5. **Lea Lani Lauvaka** – USP (PowerPoint)

1. Ngametua Pokino – Cook Islands (PowerPoint)



Slide 1

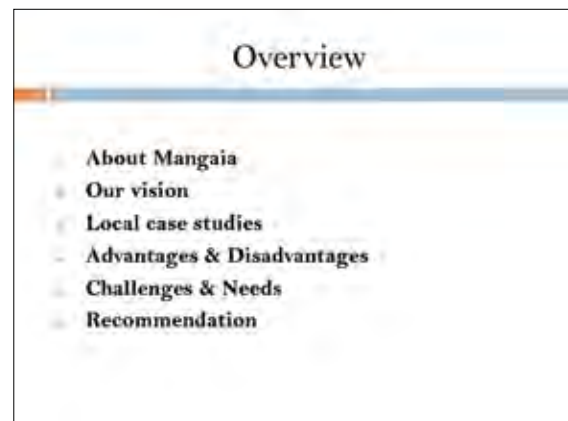

Slide 2



Slide 3

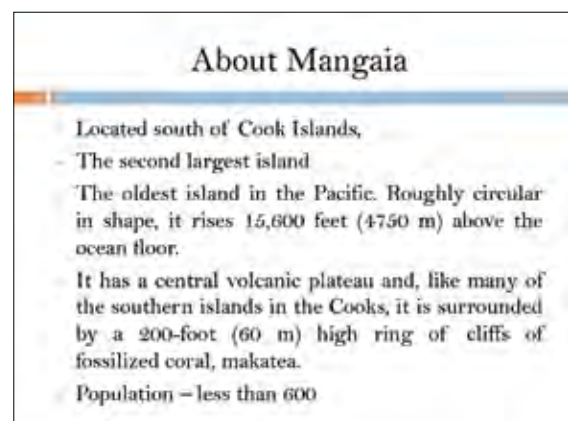

Slide 4

Aerial view of Mangaia Island



Slide 5

What about the shape?



Slide 6

Our National Vision

"To enjoy the highest quality of life consistent with the aspirations of our people in harmony with our culture and environment"

Goal 6 – Environment for living
'A Cook Islands where we sustain our ecosystems and use our natural resources efficiently'

What natural resources? Our natural and indigenous skills in building houses, churches etc. We need to sustain it for many reasons, for economic purpose, social reason, cultural values etc.

Slide 7

Sustainability - Tamarua Christian Church 1865



Slide 8

Last renovation 1990



Slide 9

Proposed plan to renovate, 2015



Slide 10

Advantage

- Retention of traditional history, cultural values, original arts and designs
- It identifies who we are against others
- The materials are resilient – lasts long term
- Ideal to for attracting tourists on the island.
- Opportunity to modernize the original building concept
- Cost effective because of all local materials

Slide 11

Disadvantage

- High risk to human – signs of deterioration of rotten poles and cracked walls.
- Traditional and cultural values, identity will be lost if not preserved.
- Probably costly to maintained

Slide 12

My 3 bedroom house, 2013



Slide 13



Slide 14

Indigenous building concept



Slide 15



Slide 16

Advantage

- Strong foundation and structure – cyclone proof,
- Cheap - NZ\$30k (\$20k material and \$10k labor) Target group – low income families
- 80% local materials – timber, sands,
- No steel metal inside the walls,
- Indigenous building and designing skills are preserved

Slide 17

Disadvantage

- Local timber not treated,
- Labor intensive,
- Costly to paint exposed timbers

Slide 18

Challenges

- Knowledge aren't been taught to younger generation (working population).
- Declining population.
- Western culture influence

Slide 19

Needs

- Need to include this into the school curriculum
- Market the advantages to the youths and working population (esp cost effective)
- Run workshops and training for youths on the designs/skills set needed (similar to vaka building).

Slide 20

The way forward

- Incorporate this into national plans – so it can filter to specific projects within the community
- Selling the affordability concept, especially during the high cost of living context
- Tie it in with other cultural events that we observe annually like celebrating constitution
- Sharing the know how with everyone using social media tools to engage people and preserve cultural norms and values.

Slide 21

Recommendation

- Revitalization of indigenous architecture and building skills must be filtered through national goals, policies and community levels, to include society, schools, development banks, rural area, low income families etc
- More research and studies are required to ensure that indigenous building skills are preserved for our future generation.

Slide 22

2. Mere Velavela Dalituicama – Fiji (PowerPoint)

REVITALIZATION OF INDIGENOUS ARCHITECTURE & SUSTAINABLE BUILDING SKILLS

A FIJIAN PERSPECTIVE
3RD – 8TH NOVEMBER, 2014
APIA, SAMOA

Slide 1

INTRODUCTION

- Traditional architecture of Fiji is unique in structure and form : Bure (pronounced mBure).

Physical Features :

- Base structure (yavu) is raised platform made of stones stacked and filled with soil and sand.
- A wooden skeleton structure made of thatched reeds sits on the base.
- Ancient bure has a slave or two buried with the centre pole.

Significance :

- Depicts status of the owner in a village setting.

Slide 2

A traditional bure structure

Slide 3

Types of bure in Fiji

- Rausina - circular in plan (family house)
- Vasemasema - squarish in plan (family house)
- Vale - family house
- Burekaifou (temple or spirit house)

Motokou: traditional bure builders

History - prior to the construction of a chief's bure a bokola's (slave/enemy) body will be buried with the centre pole; it is believed the spirit of the bokola will guard the bure.

Slide 4

SITUATIONAL ANALYSIS OF BURES IN FIJI

- Itaukei negligence of indigenous cultural practices and customs.
- Globalisation, westernised approach influenced mind set of young & old.
- Art of building traditional house is dying, bures are rarely seen in villages or peri-urban centres.
- Navasa village in western Viti Levu is a model village with traditional bures in Fiji.
- Though bures fail to exist in villages, communal houses (vatenivanua), Chiefs residence retain features of bure and raw materials e.g. Viseisei village in Nadi, Vatanitawake in Bau etc.

Slide 5

Influence of bure designs on modern architecture i.e. old Parliament, Great Council of chiefs buildings and hotels & resorts.

Slide 6

- Bearers of knowledge exist, lack of support and provision to transmit knowledge & skills.
- Access to raw materials is a problem due to deforestation & fires.
- WWF conducted workshop of replanting dakua, vesi and sogu or raw materials to build bure.



Slide 7

VISION

"A sustainable (Taukei) Society fostering the revitalisation, of the unique indigenous architecture in Fiji."

Achieved through :

- Fostering of formal/informal education in traditional architecture at all levels;
- Development of management plan systems to safeguard knowledge & skills;
- Increased advocacy & development of proper communication and promotional tools of bure building, its significance, relevance to issues i.e. global warming, climatic adaptations and living;
- Empowerment through legal provisions e.g. proposed Village By-Laws which will enhance protection of concept.

Slide 8

UNDERPINNING SUSTAINABLE DEVELOPMENT

- Relates to progress conducive to cultural principles, ideals & sustain use of local resources for future generations.
- Traditional Fijian society – there is exploitation of resources & knowledge through modern developments.
- Major downfall – changing perceptions & mindsets of people with "easy money" and "shortcut attitudes."
- Mana, Sau & Aura associated with cultural space, Chiefs are lost because more emphasis focused on development of environment & resources.

Advantages :

- Materials – available locally and cheap.
- Reviving Cultural heritage – Transmission of knowledge & skills to the younger generations.
- Influences life span - bure inhabitants live longer & healthier than those in modern concrete, wooden dwellings as natural materials are conducive to our health compared to man made materials.
- Beneficial to traditional builders in terms of financial prosperity.

Slide 9

- Documentation – recording/inventory of traditional architecture to avoid loss of vital tangible cultural heritage.
- Revitalisation programmes established through community workshops to sustain development of TK&EC.
- Incorporating traditional knowledge & culture in all facets of education curriculum.

Disadvantages

- Stronger regulations measures would allow revamp building of bure, though Ministry of Health considers it unhygienic.
- Social perceptions – people living in bure regarded as poor compared to those in modern dwellings. These worldviews deter families from considering building bure.
- Durability of the buildings – natural materials are vulnerable to wet weather conditions compared to concrete, timber & iron.



Slide 10

ACHIEVEMENTS

- Navala village unique for the South Pacific region. Currently a model village in Fiji.
- Provision of Cultural Grants with Department of Heritage & Arts. Proposed nomination of bure vakaviti mooted for Fiji in 2004 under the then UNESCO Masterpieces list – did not go through as focus was on Levuka Town as a World Heritage Site.
- Documentation and inventory system of TK & EC, assist policy makers and also identification of traditional builders.
- Fiji National University in collaboration with Department of Heritage submitted funding request to UNESCO to revitalize Navala village and bure building in September, 2014.
- Expedite nomination of Navala bure on the UNESCO ICH representative list.
- CATD a vocational institute in collaboration with Kyoto University Japan studied the "potential of traditional housing dealing with natural disasters", enhancement of curriculum.
- Culture & Education Strategy – incorporating traditional architecture elements in Technical Drawing, Woodwork subject at secondary & vocational institutes.

Slide 11

COMMON CHALLENGES AND NEEDS

- Changing people's perception and jobs in the use of bure
- Rapid loss of knowledge and skills of bure builders,
- Comprehensive documentation of bure building & identification of existing bearers.
- Access and availability of raw materials.
- TK & EC model law to be passed in Parliament to empower safeguarding and protection of TK & EC.
- Enforce revitalization of bure construction in all villages – sustainability of traditional architectural knowledge.

Slide 12

OPPORTUNITY AND LESSON LEARNED

- Work with financial banks to allow loans for building loans.
- Development of sustainable management plans for bunko to ensure continuity.
- Work towards the submission of nomination for bunko building under the UNESCO ICH Urgent Safeguarding List.
- To conduct a feasibility study on Traditional Architecture that can lead to the development of simple manuals and booklets.
- The Department of Culture together with the Institute of Tokelau Language and Culture to work with the Fiji National University in incorporating traditional architectural skills and knowledge in the School of Building curriculum.
- A seminar for all surviving traditional architectural builders in Fiji should be conducted in the future to hold a photographic exhibition, technical advice and bunko construction.
- Awareness on sustainable development on traditional architecture and revitalisation of the traditional knowledge should be of national priority.
- Access and availability of rare materials.
- TK & EC model law to be passed in Parliament to improve safeguarding and protection of TK & EC.
- Enhance revitalisation of bunko construction in all villages – sustainability of traditional architectural knowledge.

Slide 13

RECOMMENDATION

- It is our hope that through this forum, a collective voice is pursued to facilitate the revitalisation of traditional architecture in the Pacific so that the knowledge and skills is sustained and that the mana of the keepers of the land is enhanced.

Slide 14

VINAKA VAKALEVU



Slide 15

3. Ellen Anderson Higgins – NZ (PowerPoint 1)



Slide 1



Slide 2



Slide 3



Slide 4



Slide 5

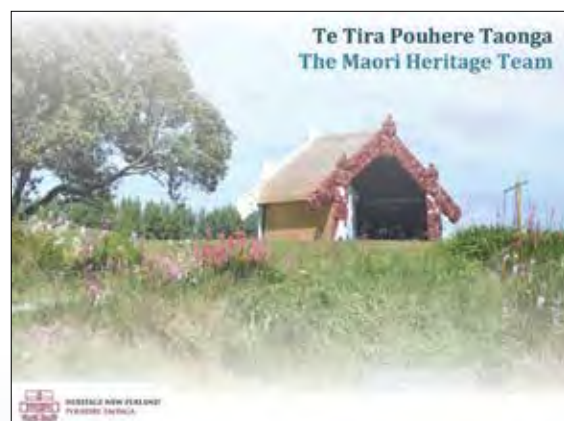

Slide 6



Slide 7



Slide 8



Slide 9



Slide 10



Slide 11



Slide 12



Slide 13



Slide 14



Slide 15



Slide 16



Slide 17



Slide 18



Slide 19



Slide 20



Slide 21



Slide 22



Slide 23



Slide 24



Slide 25



Slide 26



Slide 27

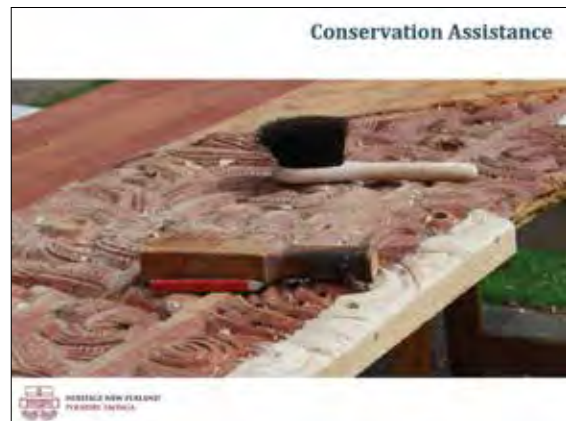

Slide 28



Slide 29



Slide 30

3. Ellen Anderson Higgins – NZ (PowerPoint 2)



Slide 1



Slide 2



Slide 3



Slide 4



Slide 5



Slide 6

Annex II Presentations from Pacific Experts



Slide 7



Slide 8



Slide 9



Slide 10



Slide 11



Slide 12



Slide 13



Slide 14



Slide 15



Slide 16



Slide 17



Slide 18

Annex II Presentations from Pacific Experts



Slide 19



Slide 20



Slide 21

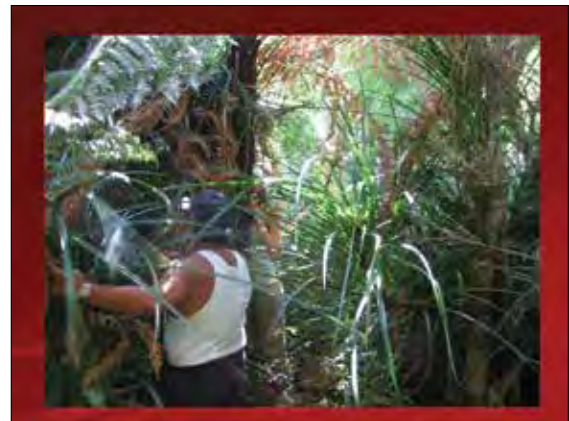

Slide 22



Slide 23



Slide 24



Slide 25



Slide 26



Slide 27



Slide 28



Slide 29



Slide 30

Annex II Presentations from Pacific Experts



Slide 31



Slide 32



Slide 33



Slide 34



Slide 35



Slide 36



Slide 37



Slide 38



Slide 39



Slide 40



Slide 41



Slide 42

Annex II Presentations from Pacific Experts



Slide 43



Slide 44



Slide 45



Slide 46



Slide 47



Slide 48



Slide 49



Slide 50



Slide 51



Slide 52



Slide 53



Slide 54

Annex II Presentations from Pacific Experts



Slide 55



Slide 56



Slide 57

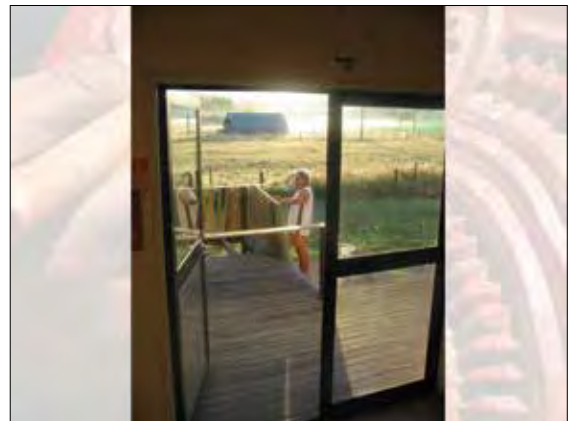

Slide 58

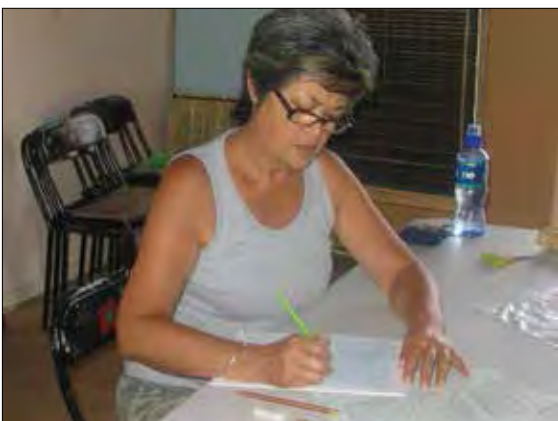

Slide 59



Slide 60



Slide 61



Slide 62



Slide 63



Slide 64

4. MNRE/PUMA – Samoa (PowerPoint)

PUMAs Role & Traditional Houses

Planning and Urban Management Agency
Ministry of Natural Resource and Environment

Slide 1

PUMAs Mission:

- To provide for the fair, orderly economic and sustainable use, development and management of land including the protection of natural and man-made resources and the maintenance of ecological processes and genetic diversity
- To enable land use and development planning and policy to be integrated with the environmental, social, economic, cultural, conservation and resource management policies at regional, national, district, village and site specific levels.
- To create an appropriate urban structure and form for the development of Apia and other centres so the as to provide equitable and orderly access to transportation, recreational, employment and other opportunities
- To secure a pleasant, efficient and safe working, living and recreational environment for all Samoans and visitors to Samoa
- To protect public utilities and other assets and enable the orderly provisions and coordination of public utilities and other facilities for the benefit of the community
- To balance the present and the future interest of all Samoans

Slide 2

Presentation Outline

1. Planning and Urban Management Agency
2. Town Planning - Apia Spatial Plan
3. Development Assessment
4. Compliance Monitoring and Enforcement
5. Traditional Housing
6. What we learned

Slide 3

1. Planning and Urban Management Agency

- **Key Role:** To Provide for the fair, orderly economic and sustainable use of land including the protection of environment and resources
- **Governance** - Minister – Board – CEO – Administrative Head of PUMA - Agency
- **Structure**- 3 division with 26 employees including project consultants

Slide 4

2. Town Planning

- PUMA is committed to develop adaptation measures for climate change
- First Step was the formulation of the National Urban Policy
- Following the ASP will be the formulation of more detailed plans i.e. the CDS and SMPs

Flowchart: Samoa Development Strategy 2012-2016 → National Urban Policy - 2013 → Apia Spatial Plan 2014 → City Development Strategy Feb 2015 → Sustainable Management Plans

Slide 5

ASP Initiatives – Climate Sensitive Urban Design

- **Climate-Sensitive Urban Design**
 - Sustainable designing of structures/infrastructures to suit local climate and weather.
 - Promote use of energy-saving designs. Renewable energy is a prime example
- **Water Sensitive Urban Design**
 - All streams and storm water are a resource, not a liability.
- **Safety and Health Through Sustainable Climate Sensitive Urban Design**
 - Comfortable environment that encourages Social Engagement
- **Benefits of Public Open Spaces and Urban Greenery**
 - Health Benefits (stress relief, physical exercise)

Slide 6

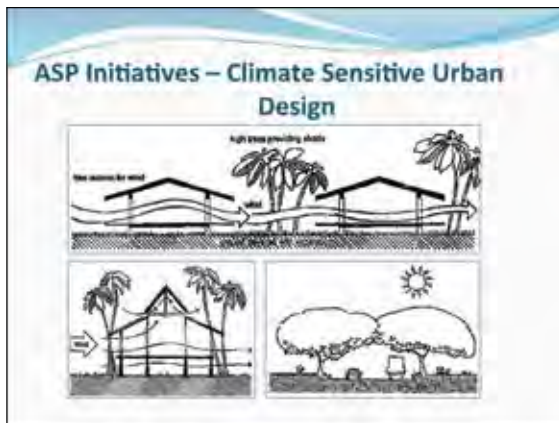

Slide 7



Slide 8

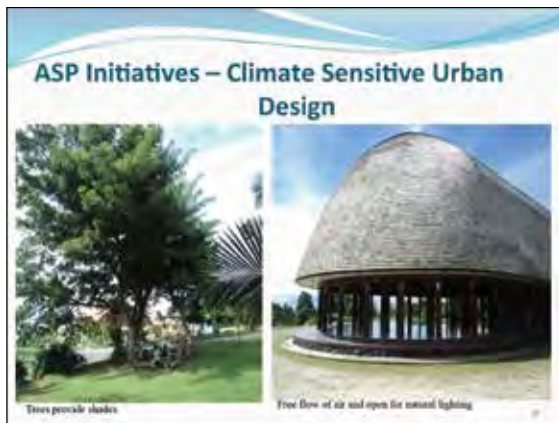

Slide 9



Slide 10

3. PLANNING AND DEVELOPMENT ASSESSMENT

- **Developments needing Consent:**
 - All development needs a consent unless a sustainable management plans (SMP) or regulation provides otherwise
- **Development not needing Consent**
 - Development specified under SMP or regulations as not needing consent
- **Prohibited Consent**
 - An SMP or regulation may provide that specified development is prohibited

Slide 11



Slide 12



Slide 13

4. Compliance Monitoring and Enforcement

- **Compliance Monitoring**
On-field inspections to ensure that consent holder (developer) fully complied with conditions of development consent
- **Enforcement**
Issuance of Stop Orders (in accordance with section 80 (i) of PUM Act 2004) to on-going developments without development consent.

Slide 14

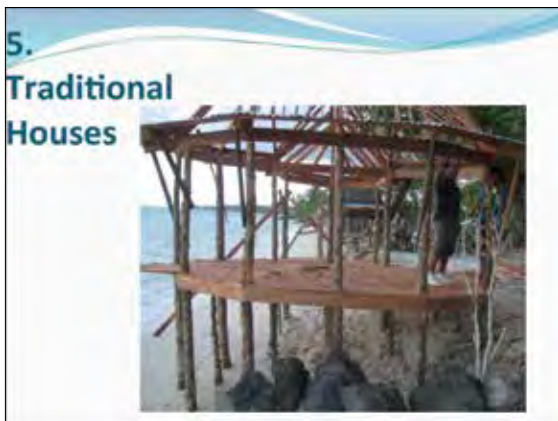

Slide 15



Slide 16



Slide 17



Slide 18



Slide 19



Slide 20



Slide 21

6. What we Learned

- Designs of traditional buildings have changed greatly over the years.
- Great need to produce authentic traditional houses.
- Traditional buildings produce minor impacts to the environment and promotes sustainable development
- Traditional faleoos or house that are built on stilts can be use in hazards (flooding)
- Include water sensitive design when we desing our traditional houses
- Have some proper design details for our traditional house

Slide 22



Slide 23

5. Lea Lani Kauvaka – USP (PowerPoint)

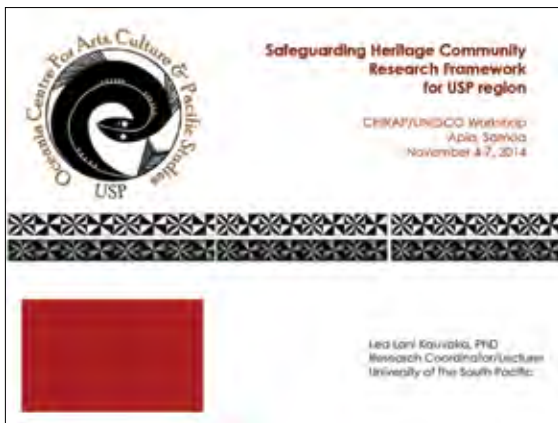

Slide 1



Slide 2



Slide 3



Slide 4



Slide 5



Slide 6

Four Pillars of Safeguarding Heritage Community Research Approach (SHACRA)

- 1. INDIGENOUS PEOPLE: ROOTS & ROUTES
- 2. Regional Connections: COOPERATION
- 3. RESEARCH CHANGES THE WORLD - & Builds Social Capital
- 4. RESEARCH IS FOR EVERYBODY - Creative Dissemination

Slide 7

SHACRA METHODOLOGY

- #1 Symbolic/Cultural, Language Inventory**
 - Archival
 - Ethnographic Interviews
 - Oral traditions
 - Library/Internet
- #2 Safeguarding Capacity Building**
 - Demonstration projects on sustainable building options for practitioners
 - Public Performances, exhibits
 - Tours/training
- #3 Creative Dissemination**
 - Curriculum website and teacher trainings
 - Schools outreach
 - Public performances, exhibits
 - Print and e-publications (articles, magazine, blog)

Slide 8

#2. Regional Connections

Slide 9

Aims & Objectives

- Strengthen peoples of the Region's housing sovereignty and resilience to natural disasters and climate changes
- Support community-based research on traditional and sustainable building for purpose of policy, code or legal frameworks
- Create curriculum around heritage (ICH, TCH and Natural Heritage) and Education for sustainable Development (ESD)
- Increase public knowledge through art, community theater, practical demonstration, skills transfer projects

Slide 10

1st Case Study: Ha'apai, Tonga

Slide 11

Earth Method: Natural sub-soil, built w/ stabilised earth or sand

- Remote Communities**
 - Low cost materials
 - Materials Easy to transport
- Skills Transfer**
 - Minimal training required
 - Low Technology
 - Can use indigenous shapes

Slide 12

Perception and Earth Building Materials

POSITIVE

- Polypropylene bags (four sacks, etc.)
- Scraped site (to stabilize courses)
- Chicken wire (to hold plaster)
- Plaster (earth or cement)
- Foundation
- Timber/iron/thatch & roof



Slide 13

Cultural perceptions and Indigenous Context



Slide 14

Container Houses





Photo Credit: www.earthbagbuilding.com

Slide 15

Bamboo



Slide 16

Recycled Materials



Bamboo Wall



Bamboo Production

Slide 17



#1 Symbolic/Cultural, Language Inventory

- Archival, Ethnographic Interviews
- Oral traditions
- Gallery/Internet



#2 Sequencing

- Capacity building
- Construction project on sustainable building strategy for post-disaster
- Public Performances, artist-in-residence
- Theaterschools



#3 Creative Dissemination

- Curriculum website and teacher training
- Schools outreach
- Public performances, exhibits

Slide 18

Heritage Research Team

- USP
 - Oceania Centre for Arts, Culture and Pacific Studies (OCACPS)
 - Pacific Heritage Hub (PHH)
 - Pacific Centre for Sustainable Development (PACSD)
 - Institute of Education (IoE)
 - Regional Centres
- Partners:
 - Private Sector Arts & Education Organizations
 - National Ministries
 - Regional Organizations

Slide 19

Annex III

Presentations from International Experts

1. Akatsuki Takahashi – UNESCO (PowerPoint)

2. Zhang Xin-An – China (PowerPoint)

3. Anne Milbank – UNDP (PowerPoint and text)

4. Kazuhiko Nittoh – Japan (PowerPoint)

5. Zhao Di – China (Text)

1. Akatsuki Takahashi – UNESCO (PowerPoint)



Slide 1



Slide 2

	2004	2005	2006	2007	2008	2009	2010	2011	2012	2013
Australia										2013
Cook Islands									2009	
Fiji									2005	2005
Guatemala									2009	
Indonesia									2002	
Kenya									2002	2013
Malaysia									2002	
Norway									2002	2013
Philippines									2008	
Poland									2002	2011
PNL									2007	2008
Samoa									2007	2012
Solomon Islands									2002	
Tonga									2005	2005
Turkey									2002	
Vanuatu									2003	2003
Total	2	1	1	2	3	4	0	6	2	2

Slide 3



Slide 4



Slide 5



Slide 6



Slide 7



Slide 8



Slide 9



Slide 10



Slide 11



Slide 12



Slide 13



Slide 14



Slide 15



Slide 16



Slide 17



Slide 18



Slide 19



Slide 20



Slide 21



Slide 22



Slide 23



Slide 24



Slide 25



Slide 26



Slide 27



Slide 28



Slide 29



Slide 30



Slide 31

-
- A Way Forward**
- Strengthen ICH safeguarding at country level (by countries),
 - Strengthen information and networking targeted on Pacific civil society, including traditional authorities, Regional IGO, and NGO.
 - Increase ratifications of the ICH Convention by Pacific member states.
 - Enhance Pacific representation of the Pacific at the ICH Intergovernmental Committee.

Slide 32



Slide 33

2. Zhang Xin-An – Chinese National Academy of Arts (PowerPoint)



Slide 1

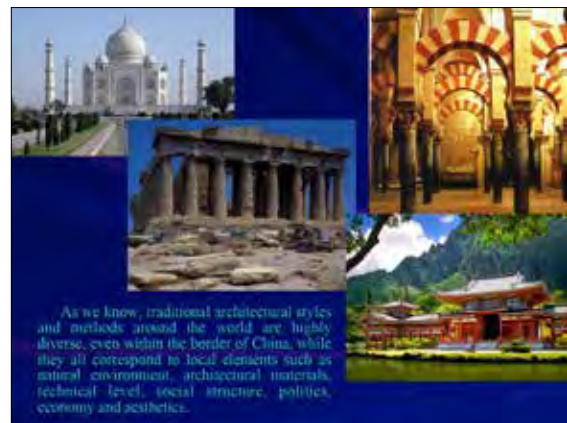

Slide 2



Slide 3



Slide 4

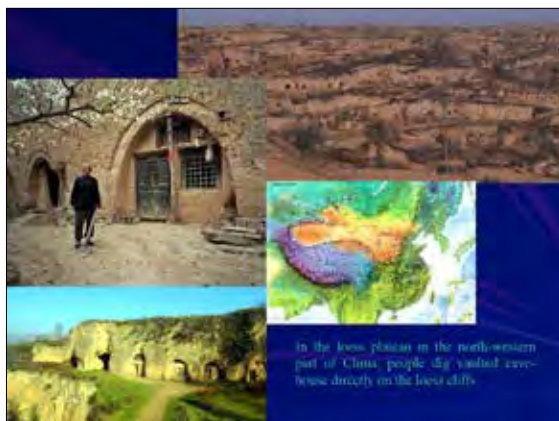

Slide 5



Slide 6



Slide 7

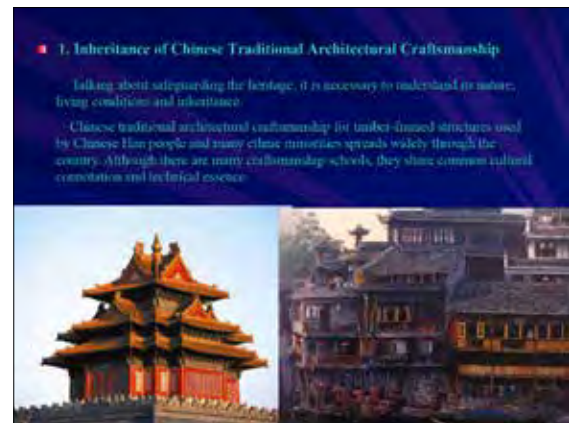

Slide 8



Slide 9



Slide 10



Slide 11



Slide 12



The social status of architectural craftsmen was not high in Chinese traditional society. Craftsmen usually worked for official or private workshops, while today most craftsmen work for the public or private companies specializing in the restoration of traditional architecture, or work for relevant museums or institutes.

However, these texts and manuals had little influence on common craftsmen. In the past, most craftsmen and artists were illiterate and they were not able to read manuals or blueprints. Even if there were blueprints, only exterior images and rough measures could be seen, while knowledge on components, the size of the modulus as well as the installation methods was all learnt from the practice and orally formula of craftsmen. The architectural craftsmanship has been handed down from masters to apprentices from generation to generation and it is still alive today.



Slide 13



Since the late 19th century, with the introduction of the construction methods of western architecture to China, the number of traditional architectures with timber-framed structure has been decreasing. Chinese traditional architectural craftsmanship for timber-framed structure has been impacted greatly by modern architecture. Its application scope is narrowing and the number of its practitioners is decreasing. Influenced by rapid development of globalization and urbanization, some of the architectural techniques are endangered or even failed to be passed down. Nowadays, the craftsmanship is mainly employed in the construction of traditional residential buildings, temples and palaces with traditional style and in repairing the ancient buildings.



Slide 14

2. Some Theories and Methods Applied in the Safeguarding Work

Here I would talk about two points: one is a concept of safeguarding, namely "Integrated Safeguarding", the other is some notes for interviewing craftsmen in the field work.



Integrated Safeguarding

"Integrated Safeguarding" has rich meanings. As to the safeguarding of Chinese traditional architectural craftsmanship for timber-framed structure, it emphasizes the relationship among the material elements of architectural craftsmanship and the relationship between the craftsmanship and its external factors.

From an internal view, the inheritance of architectural craftsmanship is collective. Bearers of the craftsmanship are craftsmen of many types who need to cooperate closely during the construction process. The architectural craftsmanship is not a personal free creation, but a kind of collective activity conducted in accordance with intentions, conventions and standards. Therefore, we should pay attention to the organization of craftsmen of different types in different procedures.

Slide 15

Except for the craftsmanship itself, other intangible cultural elements associated with the craftsmanship such as customs, including rituals and taboos related with the construction process, and knowledge on nature and society, including site selection, layout and design of architectures, etc. also need to be protected. All these elements are closely related to the craftsmanship and make up a coherent whole.

Slide 16



The tangible architecture and the intangible architectural craftsmanship substantially exist in unity. We could study the architectural craftsmanship through traditional buildings, especially when the craftsmanship has vanished and only the buildings or ruins remain. On the contrary, architectural craftsmanship is also useful for studying architectures.



Slide 17

When talking about the relationship between the architectural craftsmanship and its external factors, from an anthropological view, the architectonic and craftsmanship could give us a glimpse into the social conditions of the past, including institutions and interpersonal relationship. We could also discover cultural connotations of the craftsmanship. Since intangible cultural heritage never exists isolatedly, the safeguarding of architectural craftsmanship also includes the safeguarding of related construction customs, traditional buildings (which are carriers of the craftsmanship), and the natural and social environment on which the craftsmanship depends to live.

With the concept of "Integrated Safeguarding" and "Safeguarding original heritage", the Ministry of Culture of China has established 10 preservation areas of culture and ecology throughout the country and all the cultural elements within the areas would be safeguarded as a whole system.



Slide 18

Oral Narrative and Interview

As mentioned just now, Chinese traditional architectural craftsmanship is mainly handed down from masters to their apprentices through examples and verbal instructions without literature or blueprints. Therefore, the practices and oral narratives of craftsmanship are important resources to gain knowledge of craftsmanship, so it's necessary to interview craftsmen so as to record and study the craftsmanship. We summarized some lessons of oral narrative of craftsmen during the interview: first, the oral narratives of craftsmen are often scattered and short if systematic literature. Craftsmen usually answer the questions asked only on the interviewee needs to prepare the outline and questions beforehand, second, influenced by the local knowledge system, the concepts and vocabularies used by craftsmen might not be the one applied universally, therefore the interviewer need to make some explanation and transformation, so that the concepts and vocabularies could be accepted by the public; third, because of the different regions, schools, masters and individual practices, etc., the oral narrative of craftsmen might vary from person to person slightly or obviously, which reflects the original state-of-knowledge, in which diverse opinions co-exist before being summarized and normalized. It's possible for us to find out interesting issues by comparing different oral narratives.



Slide 19

3. Conservation Efforts

The Chinese Government has had emphasis on the significance of safeguarding traditional cultures of different ethnic groups in China by legal means at all levels. The first step of the safeguarding work is to determine the heritage lists. Traditional architectural craftsmanship for timber-framed structures has been inscribed on Chinese representative lists of intangible cultural heritage at various levels. 26 entries have been inscribed on the national list and nearly 100 on the provincial lists. Those entries inscribed on the representative lists are required to formulate detailed safeguarding plans which should be carried out on schedule.



Slide 20

Since the craftsmen are bearers of craftsmanship, they should be safeguarded and given special attention. The abundance of the architectural craftsmanship might be challenged by insufficient financial support. Some craftsmen of traditional architecture have to quit their jobs due to the low income. Some are reluctant to share their secretly handed-down crafts with outsiders. As few selection of apprentices is extremely strict, it is also hard to take on new apprentices. To solve the problems, Chinese government awards honors to representative bearers of the heritage, provides financial support and encourages them to take on apprentices and hand down the crafts.



Slide 21



Diverse of governmental and non-governmental research groups of architectural craftsmanship have been established. They have published many books on traditional architectural craftsmanship, founded Craftsmanship for Insect Architecture and Gardens, a magazine focusing on the safeguarding of architectural craftsmanship, and held some training activities to promote the inheritance of architectural craftsmanship.

Slide 22

Detailed investigation and documentation are fundamental for safeguarding the intangible cultural heritage. Especially for those endangered ethnic, it's necessary to record the heritage when the bearers are still alive. For example, it's a tradition for women of the Li people in Hainan province in China to tattoo their skins, but nowadays the young generation has abandoned the convention.



Slide 23



If the architectural craftsmanship had been well recorded, we could restore or rebuild the destroyed architectures.



Slide 24

Annex III Presentations from International Experts



Slide 25

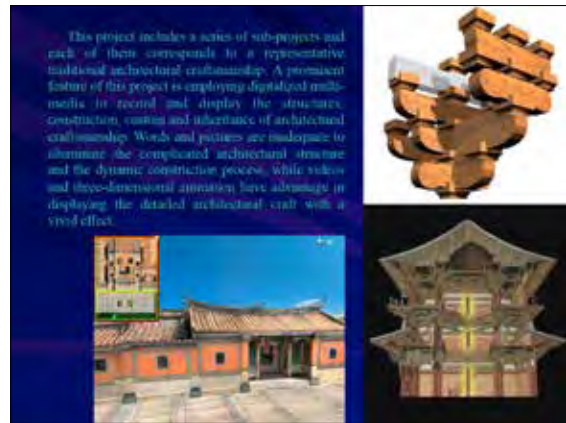

Slide 26

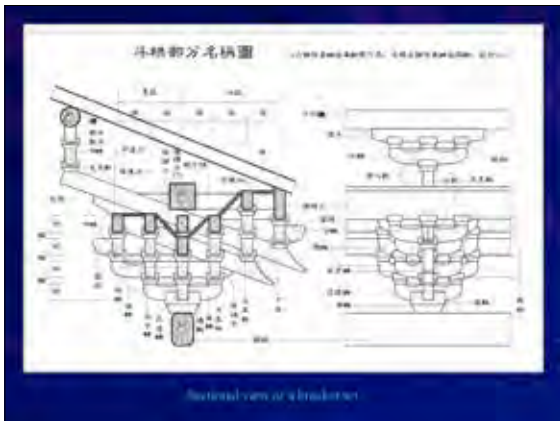

Slide 27



Slide 28



Slide 29



Slide 30



Slide 31



Slide 32



Slide 33



Slide 34



Slide 35



Slide 36



Slide 37



Slide 38

3. Anne Milbank – UNDP (PowerPoint and text)

The Samoan *fale* and Disaster Risk Reduction in the Contemporary Built Environment

Ladies and Gentlemen,

I come here today with a background in spatial design, architectural practice and architectural research. Most recently I have been the project manager/technical advisor for the Cyclone Evan Shelter Reconstruction Project being implemented by UNDP and the Adventist Development and Relief Agency. I will expand on the significance of this project presently.

The legendary *tufuga* guilds of Samoa form an unbroken line of artisans linking present day to the practices of ancient times. Generations of *tufuga* have passed on their skills to apprentices each time with small adjustments and improvements to technique and application, building on lessons learned from previous generations. The continuation of this ancient practice is now under threat as the influence of Western ideals and the introduction of manufactured goods inundate Samoan society. This workshop has been convened to identify and discuss these at risk industries and how they can survive and even prosper in the now globally influenced south pacific.

As a proponent of the technical merits of traditional architecture in climate resilient design, I will now begin this paper by briefly summarising the components of a Samoan *fale* and its functioning and location within the village. Along the way sharing an historical account of research focused on the architecture of Samoa, and how this research can potentially contribute to the employment of traditional knowledge in present day construction. As an example of this practice I will talk about the Cyclone Evan Shelter Reconstruction Project and the challenges and opportunities encountered while trying to integrate traditional architectural tectonics into contemporary climate resilient construction.

This paper will also outline the role of traditional building typologies in Samoa from a technical and economic perspective and whether the development of the *fale*, shown in the typologies mentioned in the 2011 census, which show a Westernisation of the *fale*, not a pragmatic evolution based on environmental and climatic changes, but rather on cultural and economic changes reflecting the increasing influence of the Western building typology, which has been supplanted from another part of the world. There are a myriad of cultural reasons why the Western architectural model does not facilitate Samoan living practices and now a more immediate complication has been added as Samoa suffers from the consequences of human induced climate change.

We can begin by gaining a brief understanding of the structure of the Samoan *fale* and the context in which it sits. This is just a basic overview, without the all the *fa'alavelave*. The intricacies of this craft will be further demonstrated by the actual practitioners, the many and cherished *tufuga* we have here with us today.

Unlike Western models where all functions are together under one roof, the Samoan domestic setting comprises several buildings that individually house various functions. Afakasi Maori Anthropologist Te Rangi Hiroa or Sir Peter Buck documented these various buildings and their construction styles in his seminal book *Samoan Material Culture*. We will begin by ranking these individual buildings from least to most formal.

Our first slide is blank as our taxonomy predates the latrine as building typology.

The carpenters' shed (*fale ta*) the smallest but also as the *tufugas* workshop, the most significant to the larger *fale tele*. This is a simple lean-to *fa'a se'e* structure, which is seen as a temporary building, purpose-built for the construction of guest and meeting houses. As an aside, during fieldwork I have seen many people living in structures similar to this as their primary dwelling in the aftermath of Cyclone Evan.

The canoe shed (*afolau*) used to house the long boats or *fautasi*

The canoe shed is constructed without posts supporting the ridge beam, instead relying on the rafters being embedded into the ground and tied in tension along the ridge beam for structural stability.

This first example of a pitched roof structure is instrumental in communicating the fundamental concept of structure in Samoan architecture, all buildings begin with a support for the roof, which is always the key architectural component, supplementary supports and timber floor or stone platform *paepae* are always installed later.

The cooking house (*fale umu* or *umu kuka*)

There are two versions the *umu kuka* depicted, the first has the ridge beam supported by pou that reach the ground, the second is built in *utupoto* style where the pou is curtailed and supported by a cross beam, this similar to the *fale afolau* style following.

Ordinary Dwelling house (*fale o'o*)

Still the most common dwelling style in Samoa the *fale o'o* is not built by *tufuga* but its form is heavily influenced by the *tufuga's* work. Like the *fale afolau*, the *fale o'o* roof is constructed in three sections the central *itu* or straight section and the two, curved *tala* ends. One of the more interesting improvisations is the use of chocks along the rafters to allow the purlins to form a curve along the roofline.

The meeting and guesthouses consisted of two types; the long house (*fale afolau*), and the round house (*fale tele*). It is these two house typologies that are the work of the *tufuga* that involves careful selection of timber and months of preparation on the village's part.

The (*fale afolau*) is constructed using the *utu poto* style roof structure this construction style allows for a larger girth and open plan in the mid section elimination the need for a central posts. However this does create the occurrence of double rows of posts and an elongated plan can make *fono* or meetings difficult in terms of seating hierarchy.

The *fale tele* is with its foreshortened mid section is the preferable meetinghouse with *pou* placed equidistant, more or less, from the centre of the *fale*. The trade-off being the inclusion of the centre post, or posts, which rise to the apex of the roof. This diagram shows the structure of the double curved *tala* ends.

This slide shows the scaffold structure used to construct the roof of a *fale tele* and the installation of the most architecturally unique component of a Samoan *fale* repeated nowhere else in the

Pacific – the double curvature round tala ends. The curve is created by placing the lower *lalopou* post in a semi circle, which the *tufuga* then uses timber strips to draw a curve for the apex of the roof to the ring beam atop the *lalopou*. Carefully crafting and jointing short pieces of timber form the breadfruit tree into a curved rafter that rises to approximately 45 degrees from the ring beam create the opposing curve. Once these two curves are in place, the remaining curved rafters are installed and are held vertically by the smaller purlins lashed together which will then accept the *lau* thatch panels.

In a village setting, the buildings are ranked from the least formal (profane) being the undocumented *fale le ta'ua*, to the most formal (sacred) being the *Fale Tele*.

These buildings are arranged in the village in a concentric manner radiating from the central open space, the *malae* outward to the bush and sea. Mirroring the hierarchy of formal to informal, highly visible, to obscured.

Now looking back, the first formal documentation of *fale* typologies, construction and cultural practice was by German Dr Augustin Kramer, who arrived in Samoa during the late nineteenth century. Dr Kramer was a ship's doctor and ethnographer and his account describes the rituals and formalities involved in the construction of Samoan *fale*. He provides the first documentation of the utilization of space within a *fale tele* through his use of diagrams, although the placing of the *fale tele* in a village context is yet to be addressed.

While Dr Kramer's work as an ethnologist has been invaluable to the Samoan people, and his recoding of the rituals surrounding the material culture an essential part of the Samoan architecture story, later works were even more descriptive of construction techniques.

In saying this, a proviso must be made that in all anthropological documentation, only the work of the *tufuga* being interviewed is shown and it is expected that there were many variations in technique across the islands that would indicate authorship for the *tufuga*.

The first Samoan to record the components of the Samoan *fale* was historian and public servant Teo Tuvale in "An Account of Samoan History up to 1918".¹ At the behest of the first New Zealand Administrator Colonel Robert Logan, Tuvale set about documenting the historical context, traditions and material culture from pre-European Samoa culminating in his critique of the New Zealand Administration who arrived at the onset of World War One. As part of this documented history Tuvale created a brief explanation of terms and several diagrammatics, labelling the parts of a Samoan *fale tele* and *fale afolau*.

In 1924, the American ethnologists, Edward and Willowdean Handy published "Samoan House Building Cooking and Tattooing",² an account of a short period of fieldwork in Samoa. Like Dr Kramer, the Handy's concentrated their efforts on documenting the *fale tele* and *fale afolau* and the involvement of the *tufuga* guild. Notably the Handy's detailed the construction of *fale* foundation showing the deep embedded posts and the building-up of the *paepae* (stone floor platform) the first drawings demonstrating the potential for the cantilevered effect of the posts to prevent lateral movement.

1 Tuvale, Te'o, *An Account of Samoan History up to 1918*. (Apia: 1918)

2 Handy E.S.C., and Handy W.C. *Samoan House Building, Cooking, and Tattooing*. (Honolulu, Hawaii: The Museum, 1924)

In the Samoan context, the most significant ethnologist publication was Te Rangi Hiroa's (Sir Peter Buck) 1930 book *Samoan Material Culture*, which remains the most comprehensive collection of Samoan construction details. Buck's primary concern was the recording of technique, as he saw technique as a more accurate method of tracing a material lineage than recording the artefact itself.³ He noted how the tracing of a technique "... indicates how different groups of people have sought to supply their material needs by adapting an old method to local material, by evolving improvements, or by inventing a new technique."⁴

Making reference to Buck's 1930 study, New Zealander Roger Neich's 1980 book *The Material Culture of Western Samoa: Persistence and Change*⁵ is a useful marker to assess the extent of architectural change across 50 years. Despite the study being brief (an account of only eight weeks fieldwork in Samoa) and addressing mainly building exteriors, Neich proposed a taxonomy based on the increasingly western forms and materialities used in Samoan domestic buildings. These buildings ranged from the *fale o'ó* to a western style constructed typology. Neich also noted social aspects such as location and monetary wealth as catalysts for change in housing typologies.

"Presently there are many Pacific island local and diaspora academics supporting the advancement of Polynesian architecture being an accepted typology in the contemporary context. Most significantly Albert Refiti's PhD thesis – "Spatial exposition of Samoa architecture" and Micah Van der Ryns anthropological Thesis "The Difference Walls Make", with many more young academics becoming committed to the recognition of Pacific island architecture."

As is clearly evident there is a very bright future in the area of research into the tradition of the Samoan *fale* and the *tufuga* guild. Presently what is needed is an acceptance that structurally and technicality the practice has much to offer in terms of sustainability and climate resilience two very significant concepts for Samoa as a member of the small island developing states. However, for these practices to survive and evolve into something that is relevant and thriving in Samoa now and into the future, significant steps must be made to preserve these ancient practices so, as Sir Peter Buck said, the continuation of the lineage of technique can occur to allow for further innovation as opposed to subjugation by another, less appropriate model.

This interruption/subjugation of lineage has often been attributed to the act of colonisation and the imposition of Western values. In her 1999 book *Decolonising Methodologies*,⁶ Maori academic Linda Tuhiwai Smith outlines the paradox of colonisation and space, in which the colonised perception of self becomes Westernised.

"For the indigenous world, Western conceptions of space, of arrangements and display, of the relationship between people and the landscape, of culture as an object of study, have meant that not only has the indigenous world been represented in particular ways back to the West, but the indigenous world view, the land and the people, have been radically transformed into the spatial image of the West"

3 Buck P.H. *Samoan Material Culture*. (Honolulu: Bishop Museum, 1930) <http://nzetc.victoria.ac.nz/tm/scholarly/tei-BucSamo-t1-body1-d1.html#n19> (accessed December 31, 2011).

4 Buck P.H. *Samoan Material Culture*. (Honolulu: Bishop Museum, 1930) <http://nzetc.victoria.ac.nz/tm/scholarly/tei-BucSamo-t1-body1-d1.html#n19> (accessed December 31, 2011).

5 Neich R. *Material Culture of Western Samoa*. (Wellington: National Museum of New Zealand, 1985)

6 Smith L.T. *Decolonizing Methodologies: Research and Indigenous Peoples*. (London: Zed Books, 1999)

Examples of this change in perception or values have become prolific in the Samoan built environment.

In a study conducted for the United Nations Development Programme, assessing the recovery of 50 households after a category three Tropical Cyclone Evan in December 2012, many rebuilt houses approximated western formalism and displayed a mixture of western and Samoan constructional techniques and spatial planning. I have observed that this approach has compromised the structural integrity of the buildings and is sometimes at odds with customary and contemporary modes of living. Of all the households surveyed there was no evidence of the lashed architecture recorded by Buck 85 years earlier. All dwellings comprised a mixture of Western and locally sourced materials. Connections were observed to be inadequately executed, predominantly using nails, and did not appear to have sufficient strength to resist forces typical of a tropical cyclone. An example being the use of stud wall connections, which rely on rigid planes for lateral stability, whilst still trying to achieve an open, Samoan style architecture. It seems there has been a disjuncture where Samoan architecture, stagnated, can no longer fulfil the needs of a modernizing culture yet modern architecture cannot fulfil the cultural and climatic needs of Samoa.

Reports into the status of housing from the Cyclone Evan Post Disaster Needs Assessment noted the higher occurrence of structural failure of western style dwellings and proposed the following as a possible solution.

Building practices and standards in Samoa need to take into consideration the country's traditional architecture, local building materials, and community-oriented life style. Samoa has a rich building tradition as embodied in different variations of *fale*. It is important to infuse its new construction of European-type houses with these building traditions. Reviving the traditional building skills, upgrading the skills of Samoan craftsmen, and strengthening indigenous architecture would be important steps in increasing disaster resilience. It must be remembered that Samoan houses were not much damaged in Cyclone Evan.⁷

It must also be remembered that Samoa has endured over 2,000 cyclone seasons to perfect their prototype, while Western architecture has been here for only 150 years.

There are several structural components that make the Samoan *fale* a unique typology for resisting cyclonic winds. The most obvious is the roof form steep pitched round roof is perfectly aerodynamic, resisting uplift. The deep cantilever post provides stability from lateral loads and finally the lashed connection allows the frame of the *fale* to flex under pressure preventing catastrophic structural failure. The lashing, in conjunction with timber joints, is able to resist forces along several axes unlike nails, which have most of its strength from adjacent forces.

The thatched *lau* roof is safe should some panels come loose during high winds pose little risk to the occupants unlike corrugated iron.

The Cyclone Evan Shelter Reconstruction Project was created at the request of the Samoan Government as it became apparent there were some families that were struggling to recover from a category three tropical Cyclone Evan that made landfall in December 2012.

⁷ Evan SAMOA Post-disaster Needs Assessment; Cyclone (Government of Samoa, March 2013)

Many families were having difficulty rebuilding their homes through lack of funds and skills and were now living in dangerous, overcrowded and inadequate structures.

The design of the Disaster Resilient House (DRH) is intended to be resilient to cyclonic winds, earthquake and high water. It is based on the design of the *fale o'ó* and *fale afolau* that is easily constructed without having to teach a plethora of new construction skills to local carpenters.

Starting from the foundation, the posts are [buried] one metre deep into the ground providing good cantilever from lateral forces as we saw earlier in Handy's diagram.

Like the *fale afolau* a ring beam is installed around the top of the posts, after which roof trusses are put in place. The up scaling of the rafters is one of the westernisations of this design to allow for metal fixings and faster construction, meaning the *fale* can be built in three days.

The roof is a steep pitched 45 degrees to resist wind uplift on the roof structure and cladding, while inside the roof space provides room for storage. The house is handed over to the beneficiaries at 80 per cent complete leaving the family to customise the house to meet their individual needs. Some have added an annex or *fa'a se'e* others have added railings and shelving or mezzanines for storage or sleeping. The open-ended gable allows for extension or even the addition of curved *tala* ends.

Certain concessions were made during the design phase of the *fale* to enable faster construction and allow for engineering modelling to be carried out. Due to the apparent lack of lashed connections noted during fieldwork, and time limitations all fixings for the house are metal.

The steep pitch of the roof design does allow for *lau* roofing if desired, however, in this project corrugated iron is used to allow for rainwater harvesting facilities and the possibility of solar panel installation.

Treated imported timber from New Zealand was used not only to allow for accurate engineering calculations to be carried out, but also to protect against termite attack and rot. The implications in using treated timber was that the timber had to be very carefully handled, and beneficiaries instructed to allow all scrap timber to be removed from site and not burned due to the chemical treatment of the timber.

This reconstruction project was implemented under very tight deadlines, however should subsequent construction projects be executed at a more measured pace, it would be preferable to employ the expertise of *tufuga* to re-educate beneficiaries in techniques of lashing and wood jointing as both of these techniques would go a long way in helping families with limited resources in strengthening their homes. However there are challenges in re-introducing this ancient technology.

Two of the most significant industries affecting the *tufuga* craft are the supply of suitable resilient timber and the production of *afa sennit*, which will be addressed during this workshop. The supply of suitable timber being affected by the lack of mature species which leads to younger trees being used, that are more susceptible to rot and termite attack; also, there is now a need to preserve what is left of our virgin native forests that are now considered unique in their biodiversity. While

these are industries are the most significance to the main structure of the *fale* there are other supporting industries at risk of being lost that are necessary components to the competition of the *fale tele* for example the production of *lau*, for the roofing, the fabrication of *pola* and weaving of the *fala papa*. Another issue is the scarcity of raw construction materials in the wake of an extreme weather event. These industries are reliant on cultivation, preparation and fabrication of a natural product, which while time consuming, require little financial outlay and have zero impact on the environment.

While the fabrication of buildings in Samoan is suffering a great loss in traditional skills it seems there have been some industries that are now thriving. Innovation is on the rise in the area of traditional boatbuilding as participation in *paopao* and *fautasi* racing as a recreational sport has lead to the revival and development of traditional boatbuilding skills.

Performing arts and *tatau* are two areas that have seen a huge revival due to the uptake of youth.

Most significantly to house building is the development of lashing techniques that have managed to keep their relevancy over time.

The following photos show the connections of outrigger floats to booms lashed together using various non-traditional materials, however the lashing technique is very similar to traditional examples. Finding new niches for traditional architecture is how it will become current and engaging in modern Samoa.

It is anticipated that throughout this workshop we will formulate innovative ways to preserve the existing knowledge of our *tufuga* and create new methods for integrating this knowledge into present day construction practices. I believe with the interagency cooperation that we are seeing here today and public awareness, there is great hope for the future of the Samoan *fale*.

3. Anne Milbank – UNDP (PowerPoint)



Slide 1



Slide 2



Slide 3



Slide 4

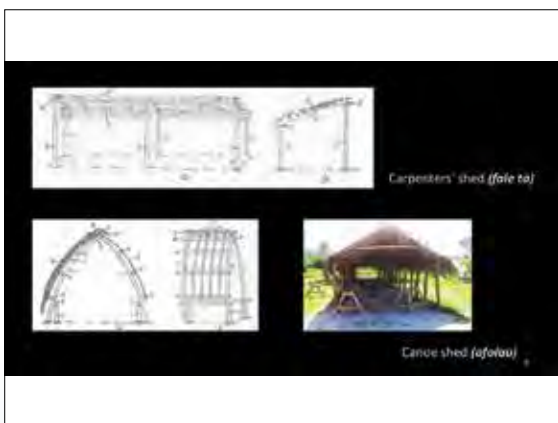

Slide 5



Slide 6



Slide 7

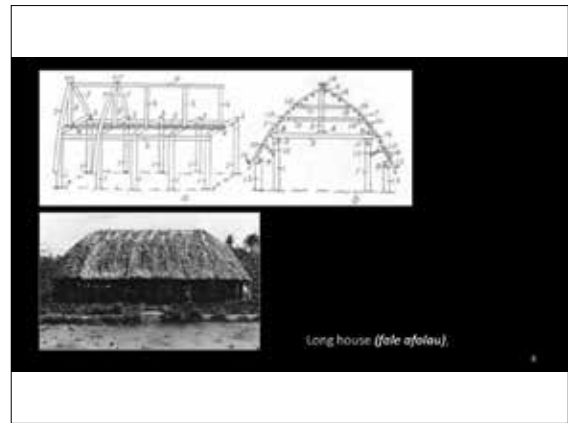

Slide 8

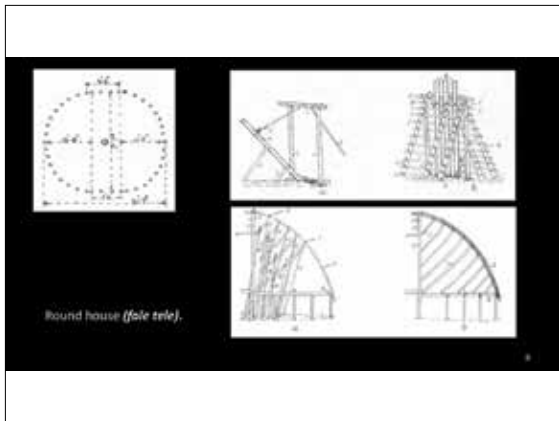

Slide 9



Slide 10

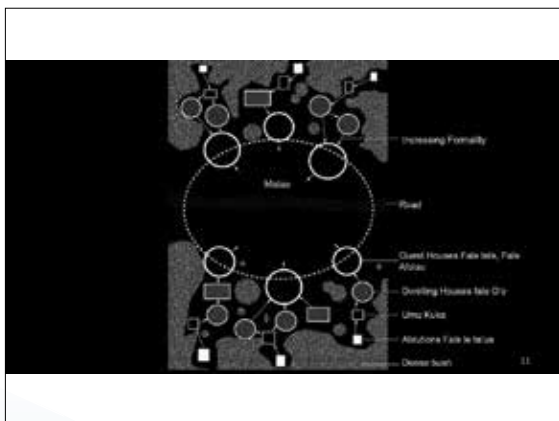

Slide 11

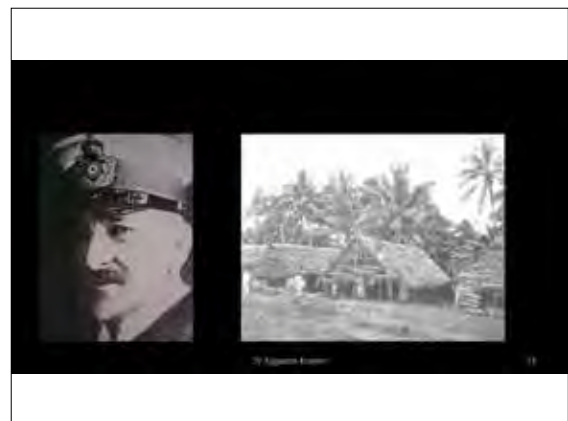

Slide 12

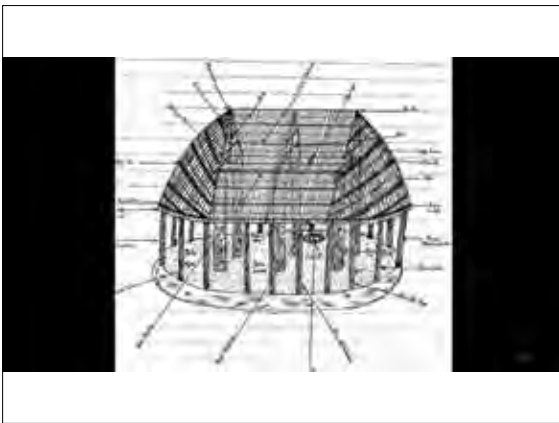

Slide 13

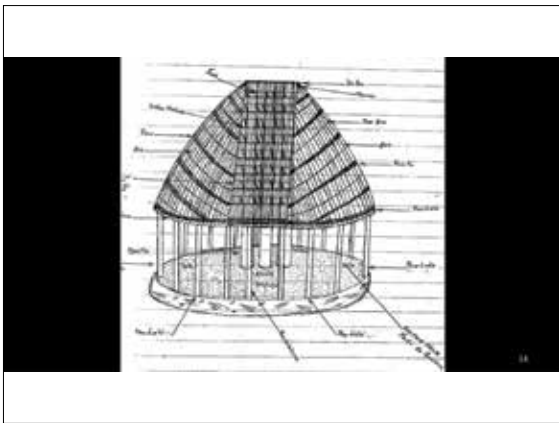

Slide 14

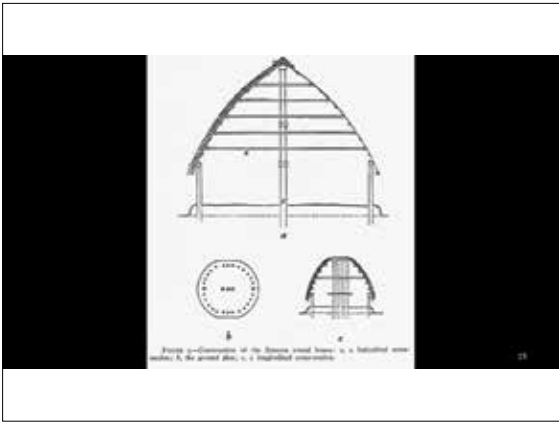

Slide 15



Slide 16



Slide 17



Slide 18



Slide 19



Slide 20



Slide 21

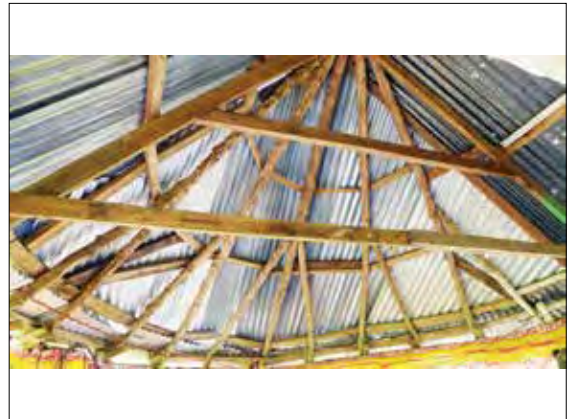

Slide 22

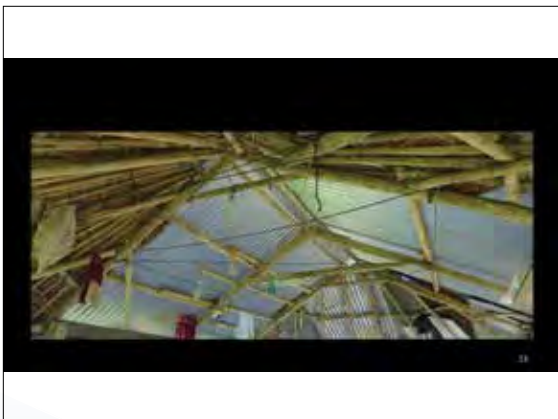

Slide 23



Slide 24



Slide 25



Slide 26

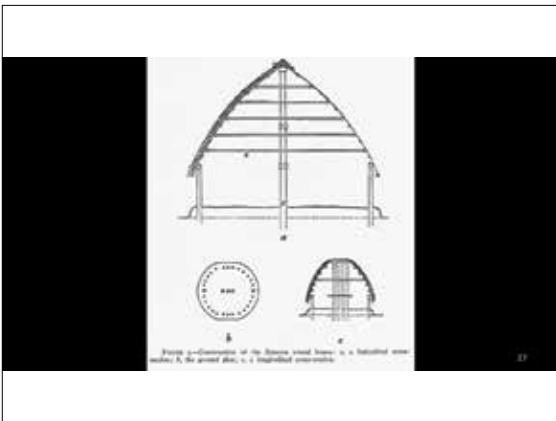

Slide 27



Slide 28

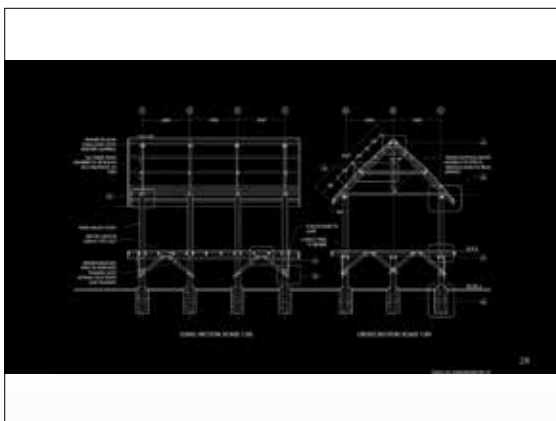

Slide 29

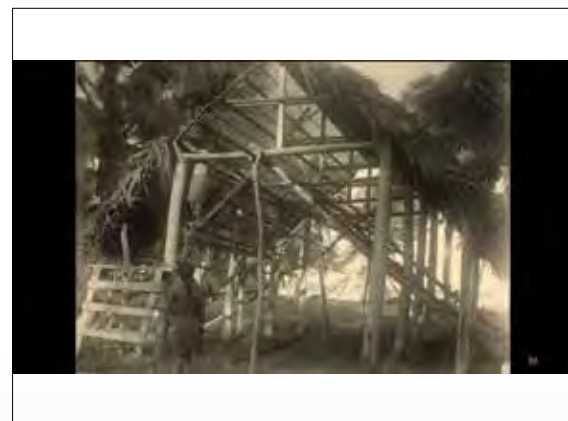

Slide 30



Slide 31



Slide 32

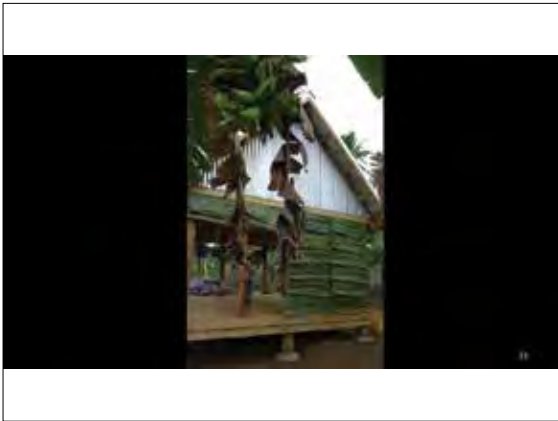

Slide 33



Slide 34



Slide 35



Slide 36



Slide 35



Slide 36



Slide 37



Slide 38



Slide 39

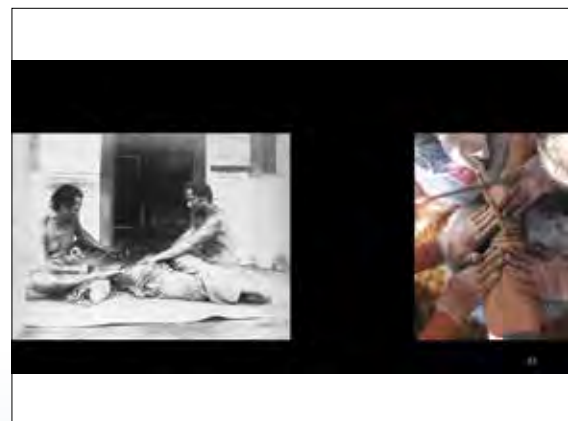

Slide 40



Slide 41

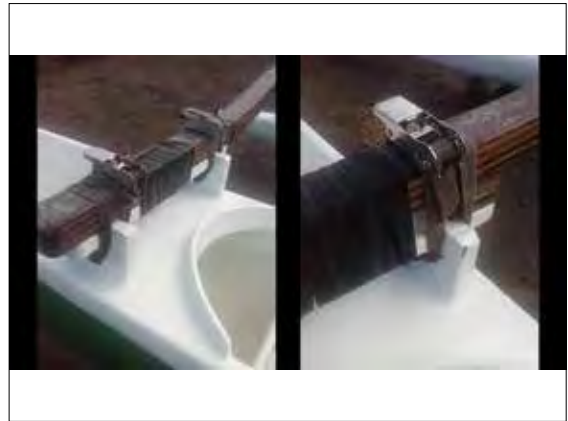

Slide 42



Slide 43



Slide 44

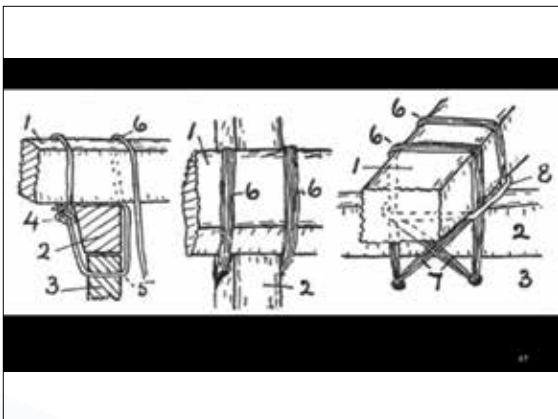

Slide 45



Slide 46

4. Kazuhiko Nittoh – Japan (Powerpoint)

日本の茅葺き技術 Thatch Technique of Japan

- | | |
|--|--|
| 1 日本の位置と気候 Location and climate of Japan | 11 茅葺き工程 社寺 Process of thatching – shrines and temples (福島 熊野神社長床 – Fukushima) |
| 2 古代の茅葺き Ancient model of thatched roof | 12 茅葺き工程 ヨシ葺き Process of thatching – Reed (東京 勝光院書院 – Tokyo) |
| 3 日本各地の茅葺き屋根形式 Roof patterns in various places 1 | 13 合掌造葺替え工程 Renewal of thatched roof (岐阜 白川郷 – Gifu) |
| 4 各地の茅葺き屋根形式 Roof patterns in various places 2 | 14 茅葺き屋根の維持 差茅 Maintenance of thatched roof – Plugging (山形 旧尾形家住宅 – Yamagata) |
| 5 棟形式の種類 Model patterns of ridges | 15 茅葺き道具 Thatching tools |
| 6 茅葺きの材料 Materials of thatching | 16 茅葺き屋根の防火対策 Antifire provision of thatched roof |
| 7 茅刈りと乾燥・集積 Thatch reaping and drying, accumulation | 17 茅葺き技術の保存 Preservation of thatch technique |
| 8 茅葺き屋根の野地 Framework of thatched roofs | |
| 9 茅葺き工程 民家 Process of thatching – Traditional house (栃木 旧羽石家住宅 Tochigi) | |
| 10 茅葺き工程 民家 Process of thatching – Traditional house (栃木 旧羽石家住宅 Tochigi) | |

著者撮影写真以外の図版・写真出典は次のとおりである/Photo Credits

栗山弘『雪の科学と生活』新潟日報事業社1984/『建築雑誌』1998年9月号 日本建築学会/川島宙次『滅び行く民家・屋根・外観』主婦と生活社 1973/三輪嘉六・宮本長二郎『日本の美術 家形はにわ』至文堂 1995/『日本発見 民家と民具』暁教育図書 1981/安藤邦廣『茅葺きの民俗学』はる書房 1983/『世界遺産 白川郷・五箇山の合掌造り集落』世界遺産記念事業実行委員会 1996/宮澤智士『INAX ALBUM19 南国の住まい』INAX 1993/吉澤政己『INAX ALBUM34 東海・中央高地の住まい』INAX 1996/後藤治『INAX ALBUM23 四国の住まい』INAX 1994/文化財建造物保存技術協会編『重要文化財旧三戸部家住宅保存修理工事報告書』伊達市 1997/巨理俊次『芝棟』八坂書房 1991/信州伝統的建造物保存技術研究会編『棟柱第2号』1999/安藤邦廣・乾尚彦・山下浩『住まいの伝統技術』建築資料研究社/相沢昭男『会津茅手』民具と生活・生活学論集1』ドメス出版 1976/下郷町教育委員会『大内宿伝統的建造物群保存地区防災設報告書』1994/木村和夫『楡皮・こけら葺屋根の燃焼実験に参加して』『文建協通信17号』文化財建造物保存技術協会

1 日本の位置と気候 Location and climate of Japan

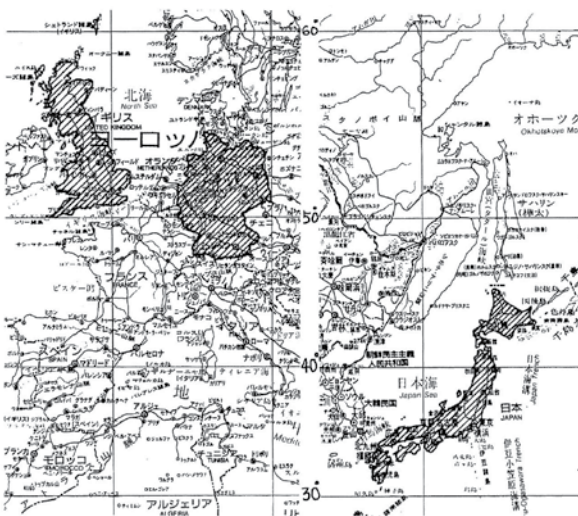

ヨーロッパと日本の位置 Location of Europe and Japan

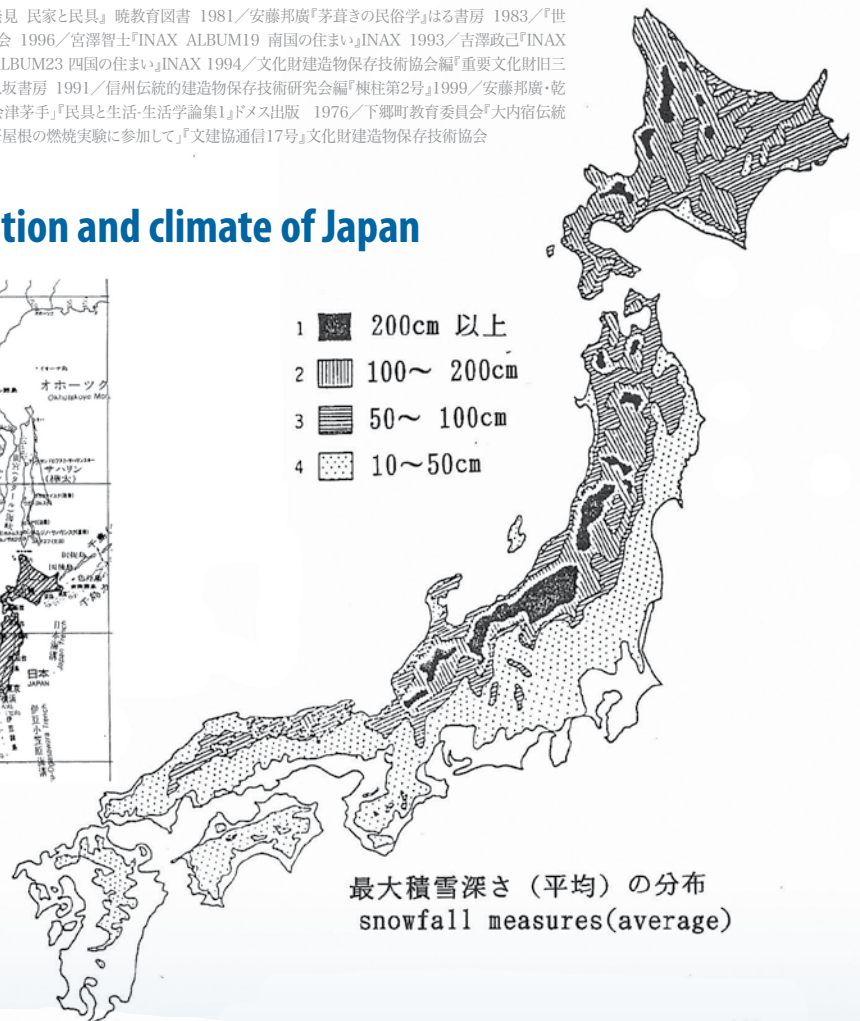

2 古代の茅葺き Ancient model of thatched roof

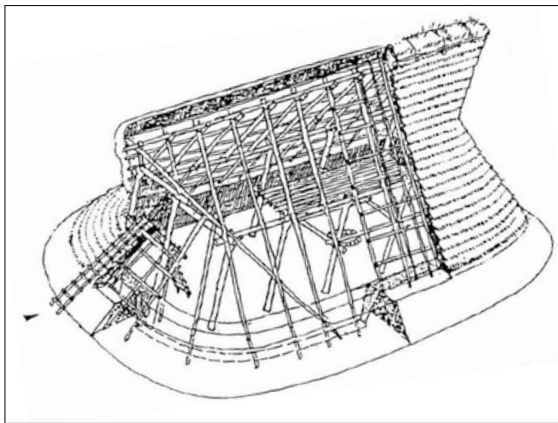

栃木 根古谷遺跡(縄文時代 B.C3C/Tochigi)

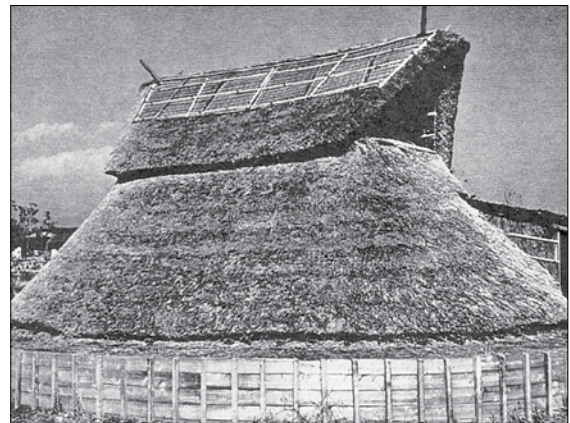

静岡 登呂遺跡(弥生時代 B.C1C)/Shizuoka

3 日本各地の茅葺き屋根形式 Roof patterns in various places

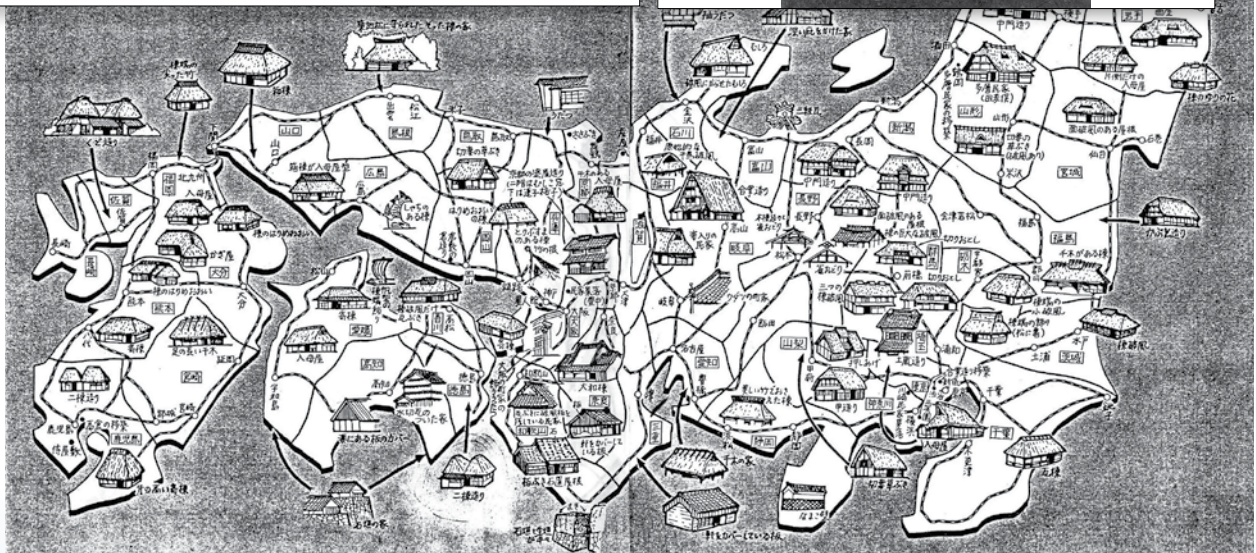
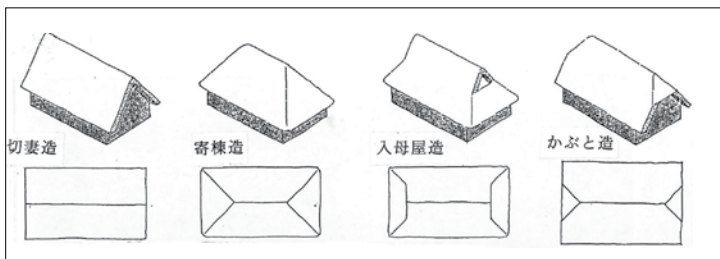

4 屋根型の基本形 Roof patterns

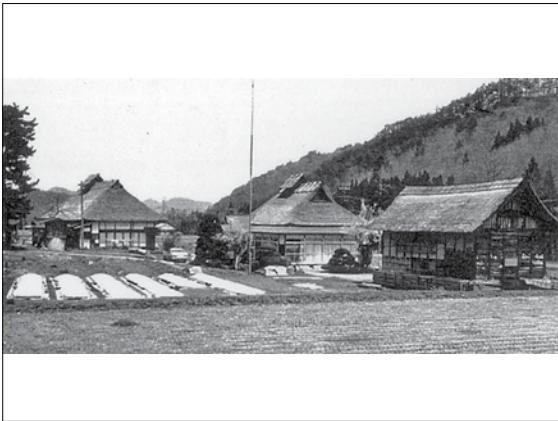

1 山形 高島町民家/Yamagata



2 新潟 目黒家住宅/Niigata



3 福井 坪川家住宅/Fukui



4 岐阜 白川村荻町/Gifu



5 福島 下郷町大内宿/Fukushima



6 新潟 旧長谷川住宅の積雪状況 / Niigata

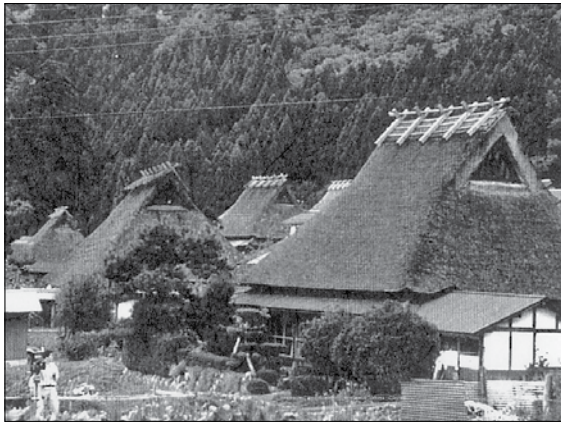

7 京都 美山町北集落/Kyoto



8 福島 熊野神社長床/Fukushima

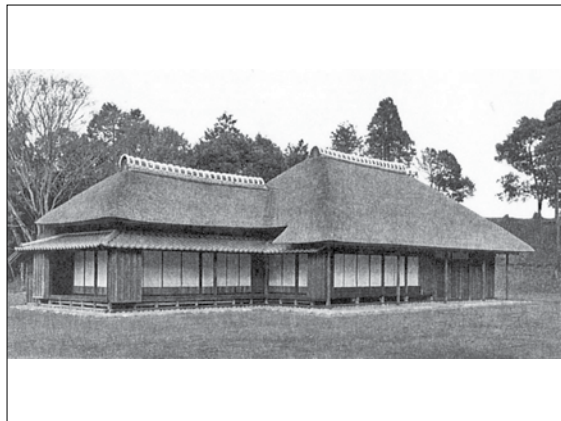

9 千葉 旧林家住宅/Chiba



10 秋田 鈴木家住宅/Akita

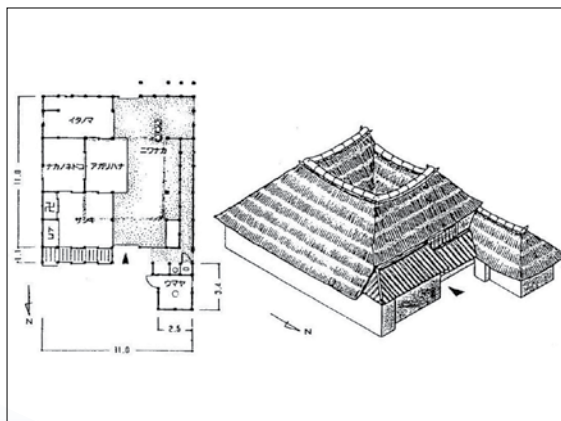

11 佐賀 山口家住宅/Saga



12 大分 神尾家住宅/Ohita



13 愛知 望月家住宅/Aichi



14 愛媛 真鍋家住宅/Ehime



15 北海道 旧三戸部家住宅/Hokkaido



16 三重 伊勢神宮/Mie

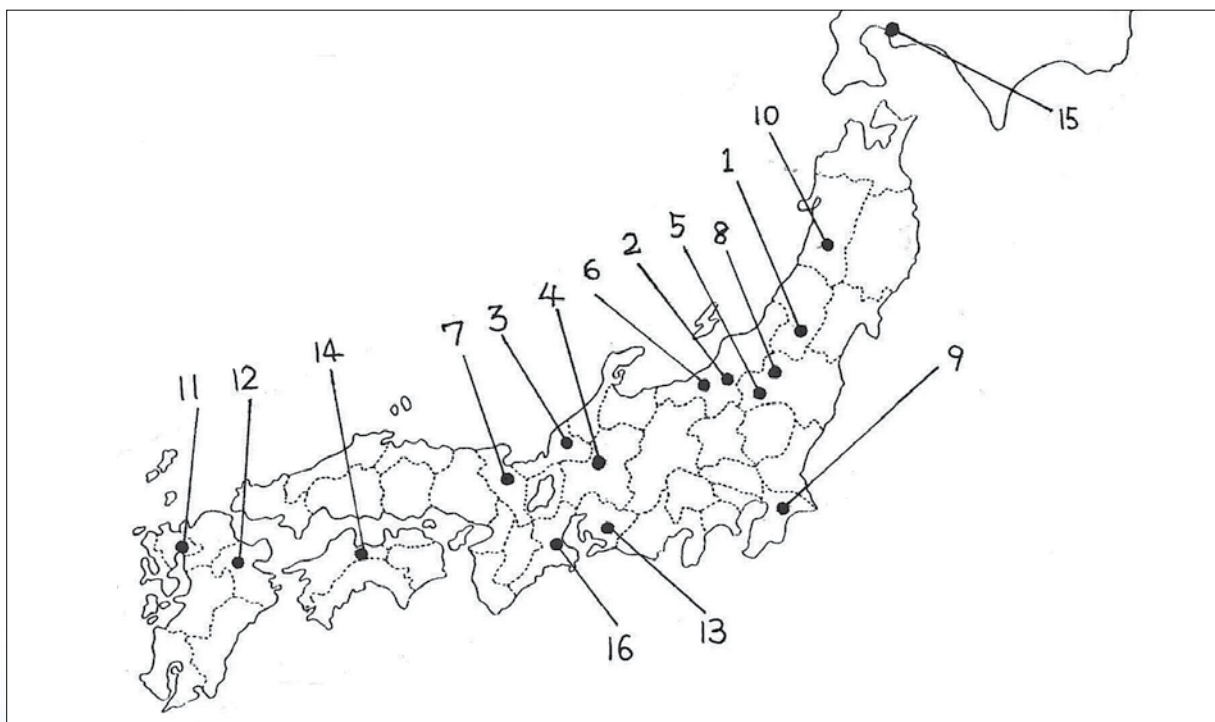

5 棟形式の種類 Model patterns of ridges

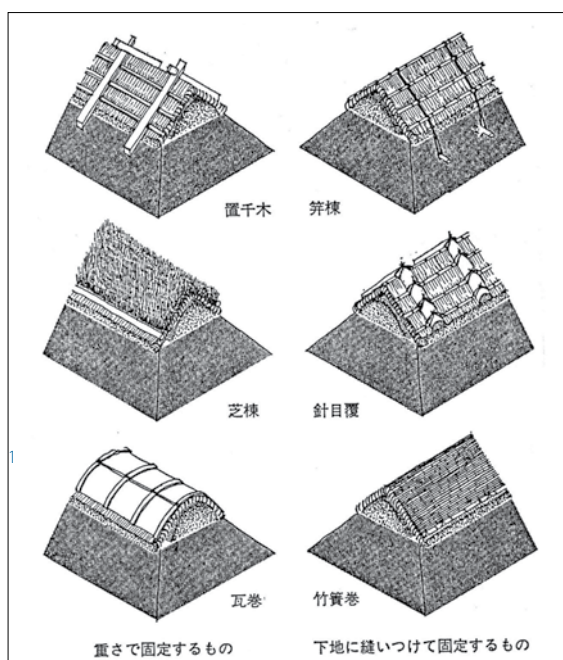

芝棟(イチハツ) 群馬 月夜野町/Gunma

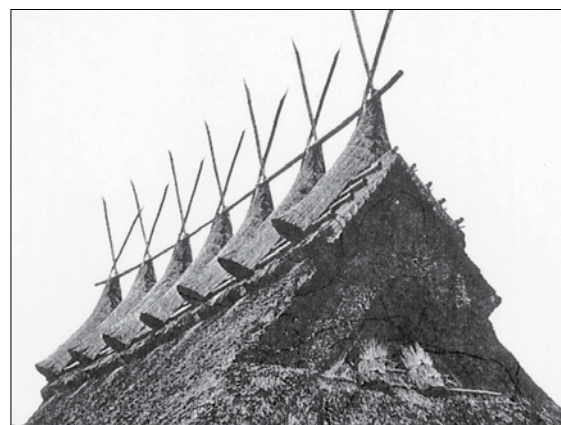

針目覆 兵庫 上月町/Hyogo

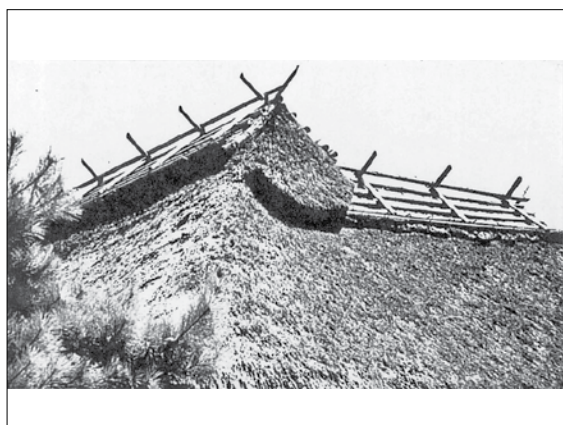

千木棟 山形 朝日村/Yamagata



千木棟 福島 喜多方市/Fukushima



針簀卷 栃木 益子町/Tochigi

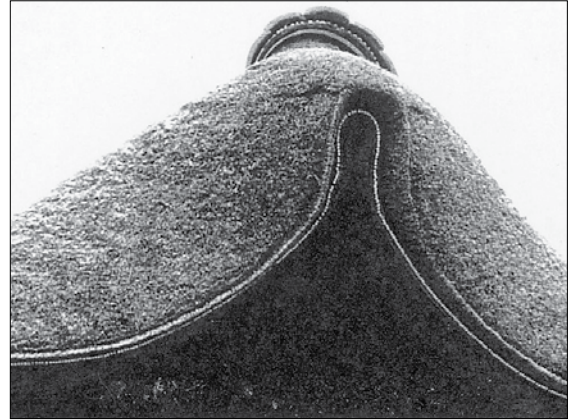

切妻破風 千葉 市川市/Chiba

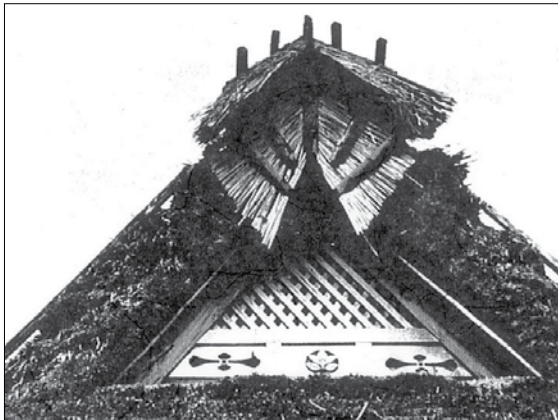

前垂れ飾り 滋賀 余呉村/Shiga

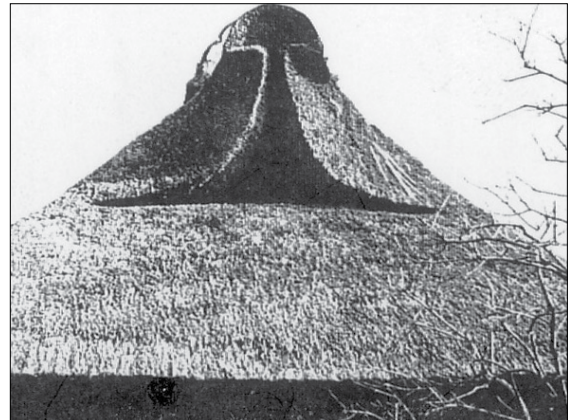

瓦巻棟 神奈川 横須賀市/Kanagawa

6 茅葺きの材料 Materials of thatching

(科)	(類)	(属)		
イネ	ササ	—————	ササ(笹) <i>Sasa veitchii</i>	
	イネ	—————	イネ(稲) <i>Oryza sativa</i>	
	ダンチク	ヨシ	—————	
	ウシクサ		—————	
		ウシクサ	オギ(荻) <i>Miscanthus sacchariflorus</i>	
		オカルガヤ		—————
		ススキ		—————
		ススキ(薄) <i>Miscanthus sinensis</i> (Pampas Grass)		
		カリヤス(刈安) <i>Miscanthus tinctorius</i>		
	チガヤ	—————	チガヤ(茅) <i>Imparata cylindrica</i>	

その他の材料 Other materials

竹 (真竹) *Phyllostachy bambusoides* / 小麦 (麦藁) Weet, Corn / 大豆 (豆藪) Soybean, Soyabean / 麻藪(オガラ) Jute,hemp

7 茅刈りと乾燥・集積 Thatch reaping and drying, accumulation



ススキMiscanthus sinensis 福島 大内宿茅場/Fukushima



ススキMiscanthus sinensis 福島 喜多方市/Fukushima



ススキの刈取りThatch reaping 長野 小谷村/Nagano



ススキの刈取りThatch reaping 茨城 河内町/Ibaragi



茅干しThatch drying 長野 小谷村/Nagano



茅の集積(にゅう) accumulation 長野 小谷村/Nagano

8 茅葺き屋根の野地 Framework of Thatched Houses

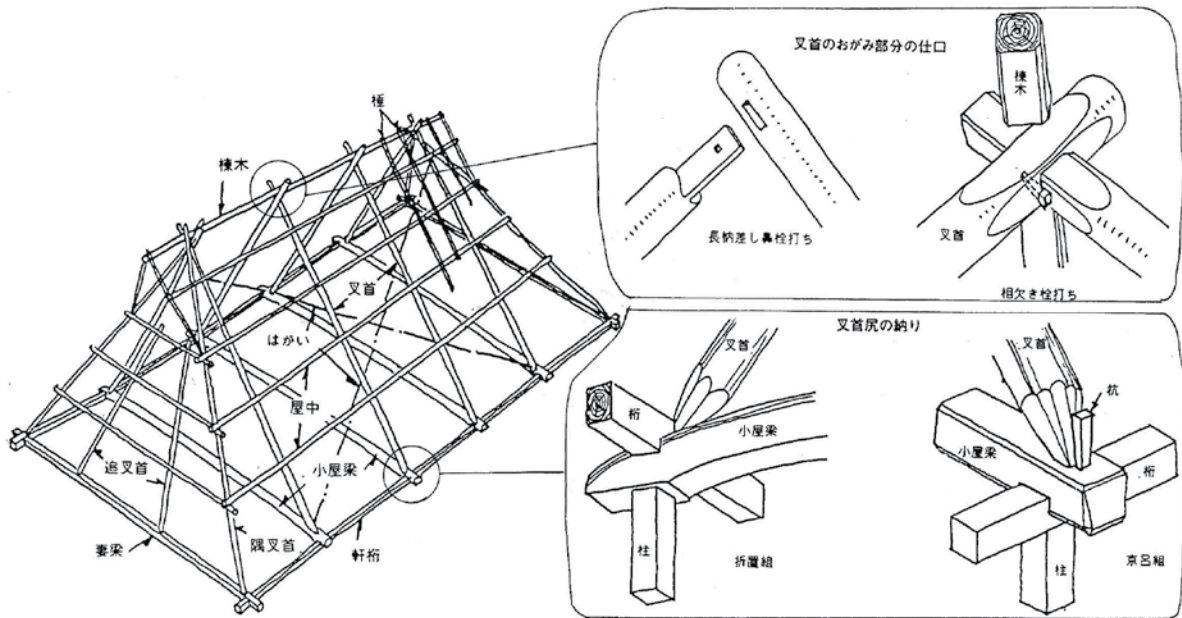

構造図(入母屋造)

仕口詳細図

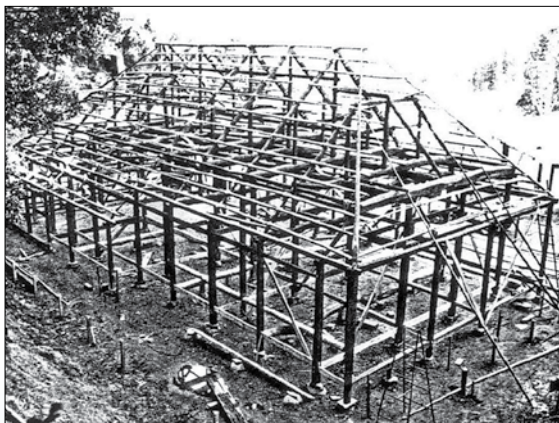
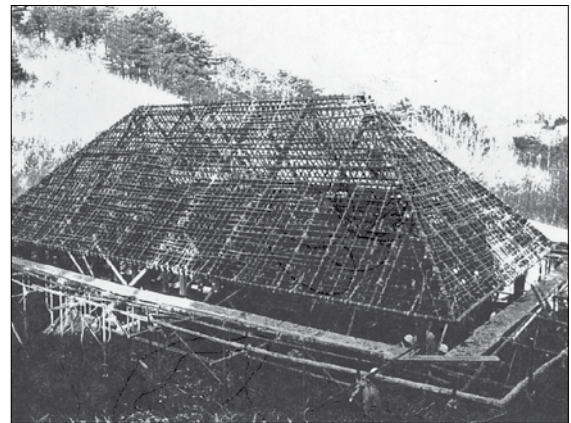
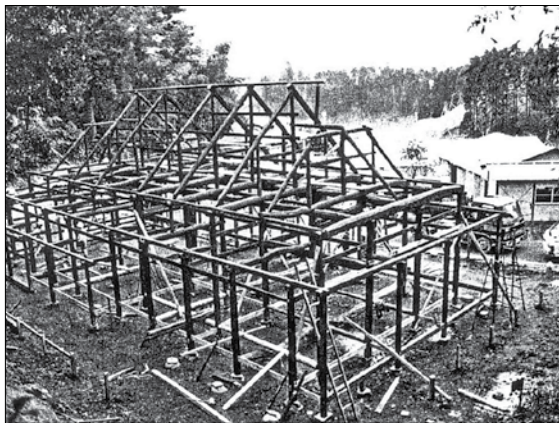

2 屋中取付け 千葉 旧藪家住宅/Chiba

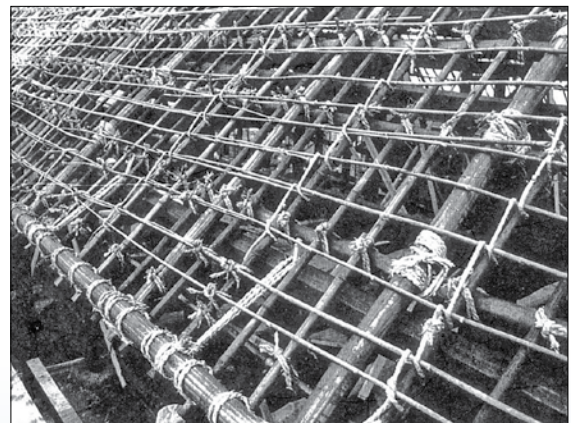

4 野地詳細 栃木 旧羽石家住宅/Tochigi

9 茅葺き工程 Process of thatching – Traditional house 1

(栃木 重要文化財旧羽石家住宅/Tochigi)

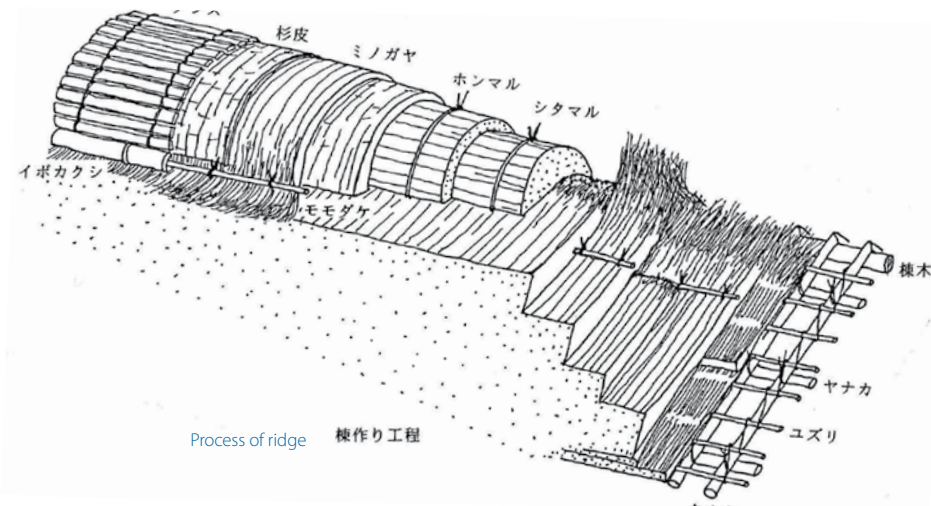

棟 竹簀巻き



棟 小口飾り(とびくち)

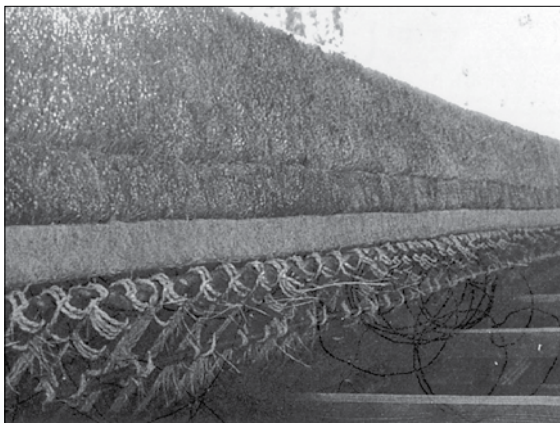

軒仕上げ(しまがけ)

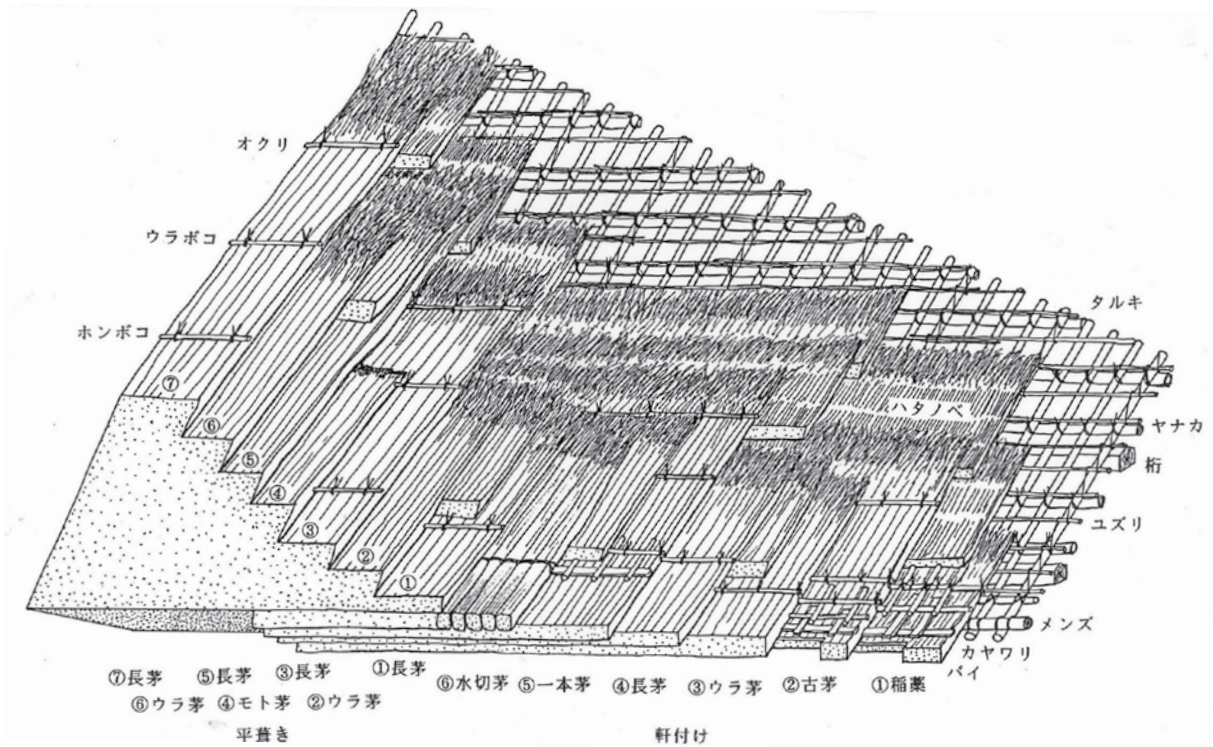

軒付・平葺き工程 Process of eaves and field

10 茅葺き工程 民家 Process of thatching – Traditional house 2

(栃木 重要文化財旧羽石家住宅/Tochigi)

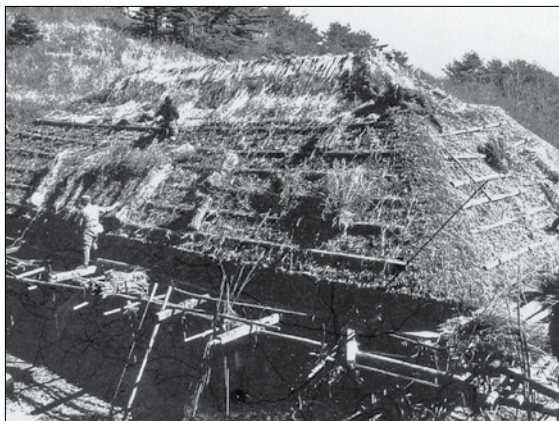

1 茅葺き上げ中 Thatching of field



2 軒付け工程(古茅・パイ・カヤワリ) Thatching of eaves



3 軒付け工程(水切り茅 Thatching of eaves



4 平葺き Thatching of field



5 棟造り(シタマル Thatching of ridge



6 刈り上げ Cutting of the surface



7 茅葺き工事完成 Thatching completion

11 茅葺き工程 社寺 Process of thatching – shrines and temples

(福島 重要文化財熊野神社長床/Fukushima)



1 茅下拵え Preparations of reed



2 軒付け(山茅) Thatching of eaves

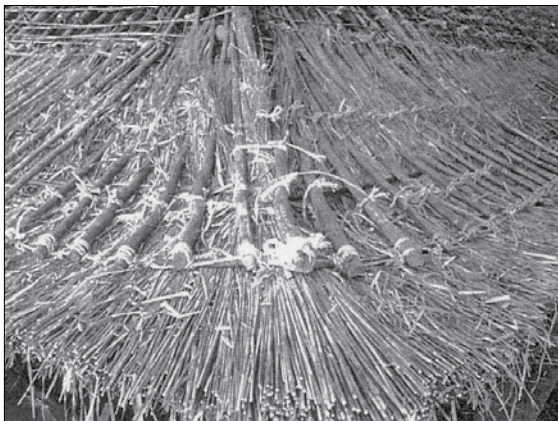

3 隅部軒付け(尺八) Corner of eaves

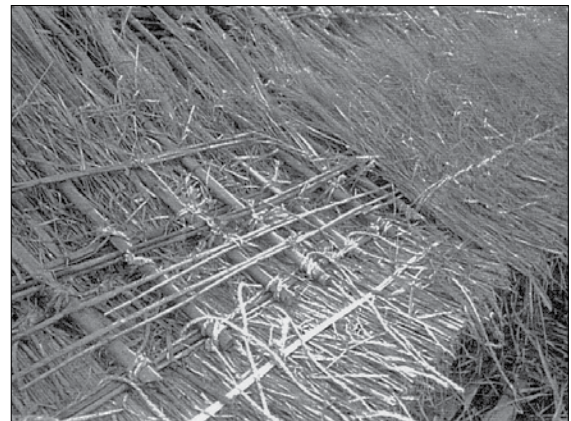

4 軒付け(尺八) Thatching of eaves



5 軒付け(水切茅) Thatching of eaves



6 隅部軒付け(水切茅) Corner of eaves



7 軒付け完了 Completion of eaves



8 葺き上げ完了 Thatched completion



9 屋根面整形(かんぎ) Regulation of roof side



10 屋根面刈込み(ハサミ) Cutting of roof

12 茅葺き工程 ヨシ葺き Process of thatching – Reed

(東京 都指定勝光院書院/Tokyo)



1 材料(ヨシ) Reed



2 軒付け(ヨシ) Thatching of eaves

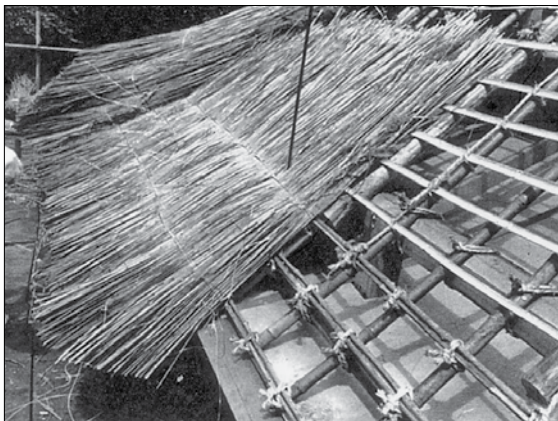

3 軒付け(ヨシ) Thatching of eaves



4 軒付け(水切りヨシ) Thatching of eaves



5 平葺き Thatching of field



6 平葺き Thatching of field



7 茅葺き上げ中 Thatching of field

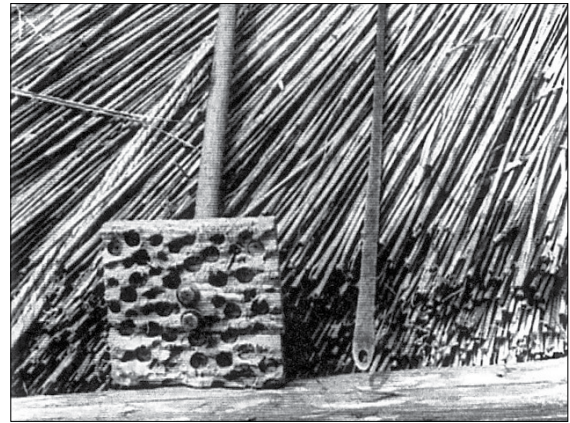

8 屋根葺き道具(ガンギ・ハリ) Thatching tools

13 合掌造葺替え工程 Renewal of thatched roof

(岐阜 世界遺産 白川郷/Gifu)



1 屋根剥き Removal of old straw

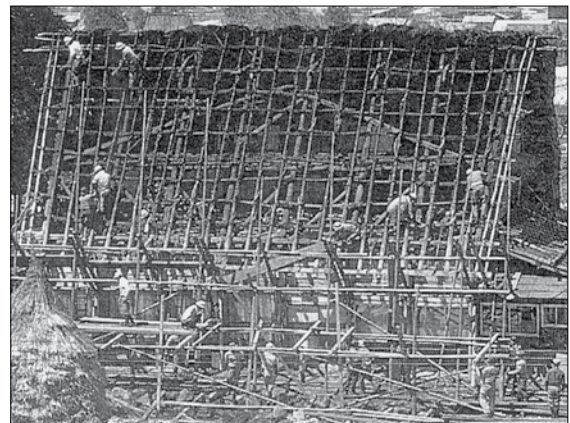

2 足場作り Scaffolding

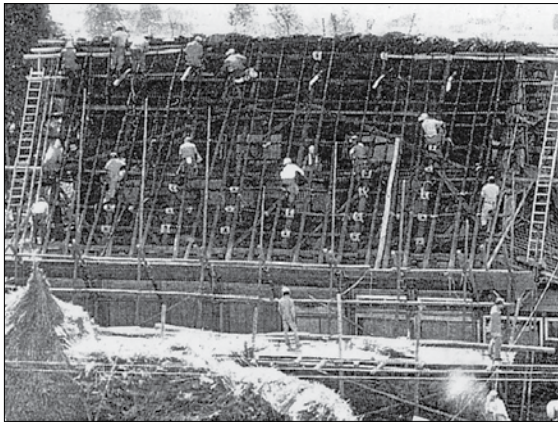

3 野地繕い Repairing framework

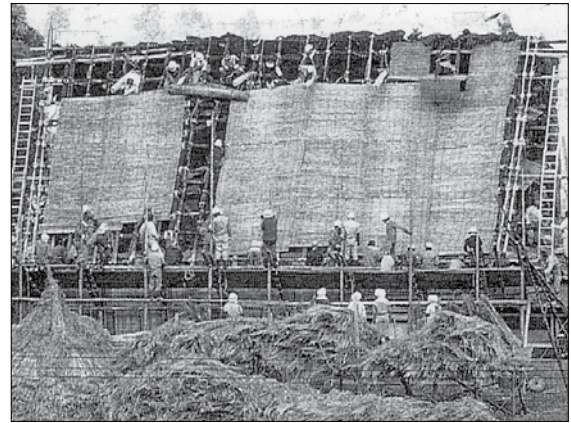

4 簀子取付け Fixing of rush mats



5 軒付け Thatching of eaves



6 平葺き Thatching of field



7 棟包み Thatching of ridge



8 仕上げ完成 Complete

14 茅葺き屋根の維持 差し茅 Maintenance of thatched roof – Plugging

(山形 旧尾形家住宅/Yamagata)



1 差木を入れて屋根面を持ち上げ、古茅を引き出す



2 屋根の隙間に短い新茅を差し込む



3 差木を外して屋根面を馴染らす



4 差し茅の完了 (山形 高島町)

15 茅葺き道具 Thatching tools

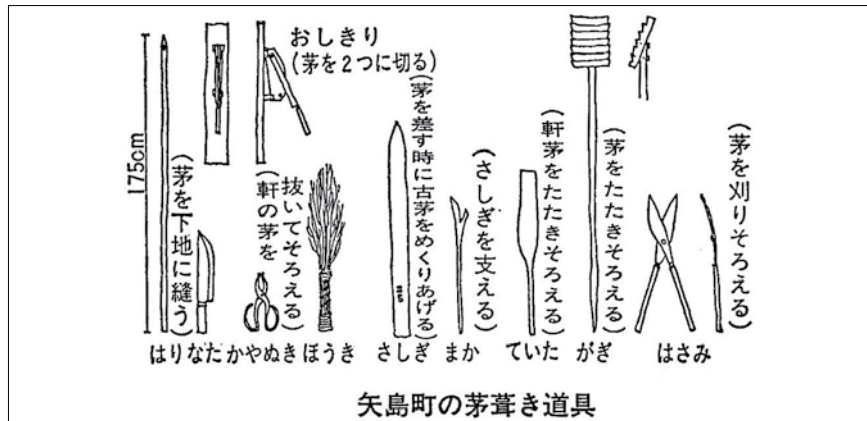
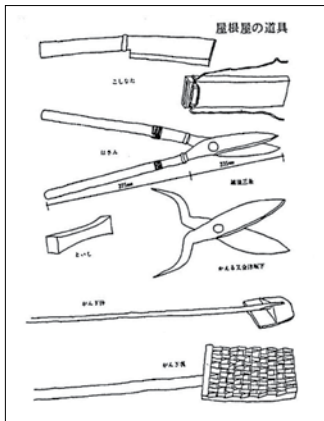

オシキリの使い方



茅葺き道具 (福島 熊野神社長床)/Fukushima

16 茅葺き屋根の防火対策 Anti-fire provision of thatched roof



1 放水訓練 (岐阜 白川村荻町) Hosing drill

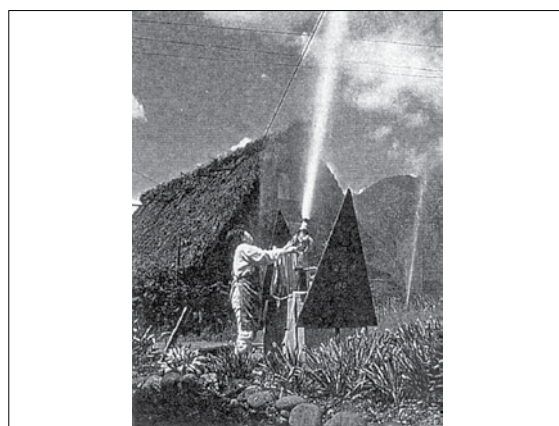

2 放水銃 Water Gun



3 屋内消火栓 Hydrant (inhouse)



4 界面活性剤の茅屋根面浸透実験 Surfactant spraying experiment



5 放水訓練 (福島 大内宿) Hosing drill



6 消防研究所での茅屋根燃焼実験 Burning experiment

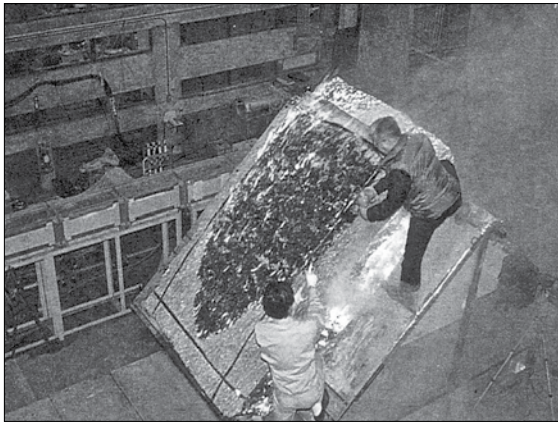

7 茅屋根燃焼実験詳細 Angle from burning experiment

17 茅葺き技術の保存 Preservation of thatch technique



1 茅葺師全国研修大会 Thatcher study session



2 若手茅葺師の紹介 (1977.11) Young thatcher

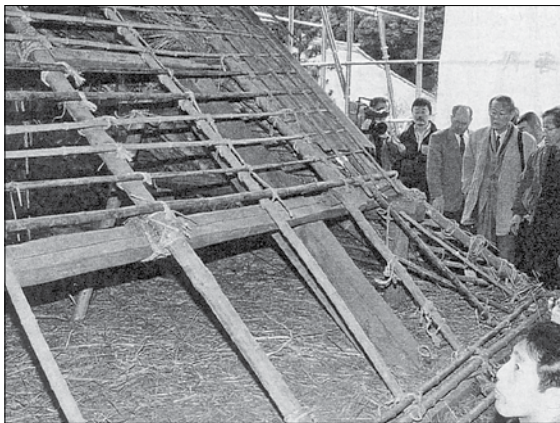

3 茅葺師全国研修大会での現場見学 Excursion (大阪 金剛寺)



4 茅葺師全国研修大会での討論 Discussion



5 国庫補助事業による茅保存庫の建設 Storage warehouse

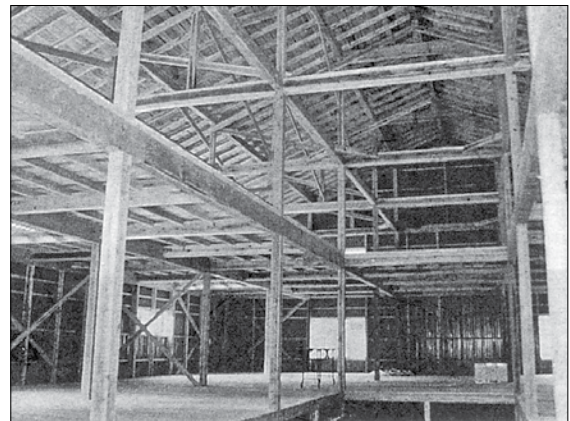

6 茅保存庫の内部 (福島 大内宿) Inside of storage warehouse



7 実物大模型による茅葺き訓練 Thatch training

Thatch Technique of Japan
 10 Nov 1998
 Author & Editor
 NITTO Kazuhiko
 (Japanese Association for Conservation for
 Architectural Monument, JACAM)

5. Zhao Di – Chinese National Academy of Arts

An Introduction to Chinese Traditional Architecture

Ladies and gentlemen,

I am very glad to have the opportunity to attend such an important international exchange. Before my lecture, I would like to introduce myself. My name is Zhao Di. I work at Chinese National Academy of Arts and I am engaged in the research of architecture history and theory.

My lecture will be divided into three parts: firstly, I'll make a brief introduction to some basic features of Chinese traditional architecture; secondly, I would like to explain two basic structures of Chinese timber-frame architecture with examples; finally, I would like to share some ideas on the protection of traditional craftsmanship.

Part 1

I come from China, a country with a long history, large population and vast territory. As for the long history, China's history with written records dates back to over 4,000 years ago; as for the large population, China has 56 nationalities, and a 1.3 billion population; as for the vast territory, the total area of China is about 9.6 million sq-km. Such an ancient nation with extensive area is destined to enjoy prosperous culture and arts with distinctive oriental features, and the culture and arts have a profound influence on the whole of East-Asia.



Pic 1: A painting from the 12th century depicts the traditional architecture style of this era.

The history of Chinese architecture can be traced back to several thousand years ago. China's architecture has reached brilliant achievements and has gradually developed its unique style. To be honest, it is impossible to show you a whole picture of Chinese traditional architecture within one hour. Therefore, I'd like to share with you the most distinctive parts. (pic1)

The main features of Chinese traditional architecture can be summarized in the following four parts:

1. Timber-frame dominated structure

In terms of building structure, we have earthwork construction, timber-frame architecture, brick masonry construction, bamboo-frame construction, etc. Wherein, timber-frame architecture is the most widely built.

For Chinese timber-frame architecture, the timber frame was made to bear the load, while the walls act only as enclosures. Connected with mortise and tenon joints, various architectural elements form an elastic unified whole. Mortise and tenon joints are an extremely brilliant invention.

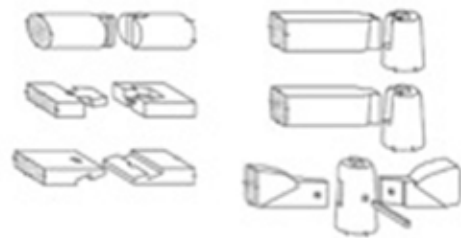

Pic 2: Examples of mortise and tenon joints

Tenon is the protruding part of the wood, and mortise is the sinkhole in the wood; When the tenon and mortise occlude with each other, the architectural elements are connected and fixed. Before starting construction, craftsmen would prepare architectural elements with mortise and tenon beforehand. When the on-site construction starts, various architectural structures can be connected by mortise and tenon joints, without using nails or ropes. The “Prefabrication and On-site Assembly Method” greatly improve the engineering efficiency. (pic 2)

The construction of the famous Forbidden City is a good example. The Forbidden City is the palace of the emperors of Ming (1368–1644) and Qing (1616–1911) dynasties, it occupies an area of 720,000 sq-m and it contains about 1,000 houses. The construction of this palace started from 1407, and was completed in 1420, taking only 13 years. Among these 13 years, most time was spent on the preparation of building materials while the on-site construction took less than five years. (pic 3)



Pic 3: The overall view of the Forbidden City

Timber-frame architecture has good seismic performance. China is an earthquake-prone country. In some earthquake-stricken areas, we frequently saw such a scene: some concrete constructions collapsed while some old dwellings, though the wall suffered serious damage, their timber frames were still there. That’s because in timber-frame architecture, it is the timber

frame that bears the load, and the wood itself is elastic. What’s more, the mortise and tenon joints enable all the architectural elements to connect tightly but not rigidly. Therefore, when exposed to huge pressure, the whole frame of the construction is elastic, so the architectural elements are not easily broken.

Every coin has two sides. The timber-frame also has disadvantages. First, it is hard to get tall and thick wood with good quality. To solve this problem, Chinese craftsmen developed the “piecing material method”. This method is to combine small wood together, then fix the combination with an iron hoop to get relatively big architectural elements. Such a method was applied in dwellings, temples, and even in the palace.

The second disadvantage of wood is it is easy to be rotten and is subject to insects. To solve this problem, many repair methods were developed so that craftsmen were able to repair architectural elements with different methods, including patching, bezel setting, partial replacement and complete replacement.



Pic 4: A typical fire-sealing wall

As you know, the greatest threat to timber-frame architecture is a fire disaster. Therefore, in some Chinese traditional architecture, vats filled with water were always put in the middle of the courtyard. But the actual effect of such emergency measures is not significant. Compared with vats filled with water, fire-sealing walls proved to be more effective. This kind of wall is very common in south China. The wall is higher than the roof of the house so that it can prevent the fire spreading.

A fire-sealing wall is beautiful and unique in appearance and although built for practical purposes, it has also become a distinctive part of the local dwellings. (pic 4)

Except for timber-frame architecture, earthwork construction and masonry construction also reached great achievements. The famous Great Wall is a good example of rammed earth construction. Anji Bridge in Zhaoxian County, built at the early beginning of the 6th century, is a significant example of stone arch construction. However, no matter in terms of the influence, or technological level, timber-frame architecture can represent the crowning achievement of Chinese traditional architecture.

2. Three-segment Composition and Modular Design

Chinese traditional architecture is normally of three segments in appearance; namely platform, body and roof. We call this kind of composition "Three-segment Composition". (pic 5)

The platform is made of brick and stone for bearing the load of the whole house. It's not only able to protect the wooden column from erosions due to rainwater and moisture, but also makes the architecture look more stable.

The body of Chinese traditional architecture consists of wooden columns, beams, tie-beams, purlin, tou-kung and so forth, with the bay as its fundamental unit. In its stereogram, the so-called "bay" can be simply defined as the part between two columns. The quantity and layout of the "bay" is various due to different scales of architectures. Building bays, generally, shall comply with four principles: first, the width of the house shall be greater than (or same to) its depth; second, the number of the bays of one house is usually singular, such as three bays, five bays, etc; third, the width of the bay in the middle of the house shall be the greatest; fourth, bays on both sides of the construction shall be completely symmetrical along its central axis. As the architectural elements of each bay are nearly the same in both type and quantity, it's able to produce these elements massively, thus the engineering efficiency has been improved.



Pic 5: An example of a three-segment composition



Pic 6: A Tou-kung

The roof in Chinese traditional architecture is quite unique. It is extremely towering. Even though it is big in size, the roof of the house doesn't make us feel repressed. That's attributed to its curved design in both a horizontal and vertical direction.

For some important constructions, there'll be a wood architectural element called a tou-kung, bracket set between the body and roof of the building. This is a distinctive part of Chinese architecture. The so-called tou-kung is a cantilever structure composed of short wood blocks and wood beams. It is used for bearing the load of the protruding roof and for decreasing the span of beams. In early times, the tou-kung was large in size, combined with the beam and tie-beam. With a role similar to a lever, the tou-kung is able to lift the eave of the roof. During the Ming and Qing dynasties, the structural role of the

tou-kung became less important and it gradually became an element for decoration. (pic 6)

There is a modular relation among architectural elements of Chinese traditional architecture, which is called the "modular system". I tried many ways to explain this system simply, and I finally found that using a maths formula is the best way. For instance, if we set x equal to the height of an adult, then the length of his head is about $1/7x$, shoulder width is about $1/4x$, the width of fully extended arms is about x

Similar to the human body, a proportional relation also exists among building architectural elements. Chinese craftsmen set x equal to the width of the particular part of tou-kung, then we get the following data:

The diameter of eave column equals to $6x$, and the height equals to $70x$;

The height of eave lintel equals to $6x$, and the thickness equals to $4.8x$;

The diameter of purlin equals to $4x$;

The diameter of rafter equals to $1.5x$

In Qing dynasty, the value of " x " was divided into 11 grades (3.2-19.2cm). Craftsmen decide the specific size of x due to the importance of the architecture.

In Chinese traditional architecture, tou-kung is an architectural element with a symbolic meaning of hierarchy. It can only be used in religious architecture, the houses of nobility, and in some public buildings. Common people were found guilty if using tou-kung in their house. For those houses without tou-kung, the diameter of the eave column will be set as " x ". For experienced craftsmen, once the value of " x " has been decided, the size of other architectural elements can be calculated. This is a symbol of the highly developed techniques of Chinese traditional architecture.

3. Plan layout of courtyard style

Compared with buildings in Western countries, the individual building of Chinese traditional architecture is relatively simple and regular. The complexity of Chinese traditional architecture lies in various combinations of individual buildings. Generally, the courtyard is the fundamental unit of a building group. The so called "courtyard" is an enclosed space created by multiple individual buildings, among which the most important ones will be located along the central axis and other buildings will be built along the sides. (pic 7)

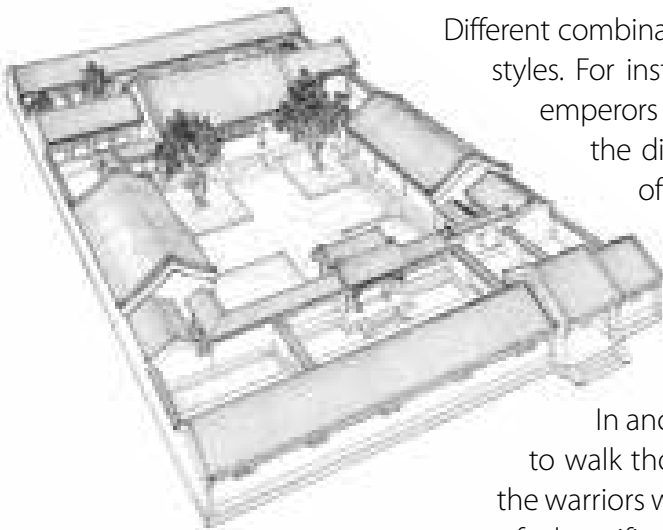

Pic 7: A traditional Beijing courtyard

Different combinations of courtyards will create different artistic styles. For instance, the Forbidden City, the palace for the emperors of the Ming and Qing dynasties, represents the dignity of imperial power. Therefore, in an area of 720,000 sq-m, courtyards in different sizes are arranged orderly. Among these courtyards, the most important ones are built along the 1 km central axis, thus creating a strong sense of ceremony.

In ancient times, anyone meeting the emperor had to walk through these huge courtyards. Along this way, the warriors with swords in their hands made the passersby feel terrified. What's more, the high wall of the palace and the enclosed courtyard make the fear and sense of repression worse. In such an environment, most of the people may feel humble and helpless and then they become compliant. That's exactly what the emperor wanted!

Chinese garden architecture, especially in private gardens, creates an easy and quiet environment as the layout of the courtyard is completely different from the Forbidden City. Chinese people long for a dwelling with a beautiful natural environment. Therefore, they spare no efforts to emulate natural landscapes by building artificial hills, water pools and planting trees in their courtyards.



Pic 8: A private garden

This kind of garden is normally of a small size. To make it look bigger, each garden is designed carefully. A water pool is usually built in the centre of the garden and other buildings are arranged around the pool. All kinds of pavilions, partitions and plants are set in the garden to block the sight of human beings. Then you have to go around the barriers in front of your eyes to see other views. Attributing to the delicate layout, the garden looks bigger than its actual size. (pic 8)



Pic 9: A decorative painting on lintel with gold leaf



Pic 10: Beasts on the eaves of the roof

4. Rich Architectural Ornaments

Most Chinese traditional architectures are decorated with rich architectural ornaments, among which decorative painting and carving are two of the most common ones. Here I'd like to talk about decorative painting, as it can not only beautify the architecture, but prevents wood architectural elements from erosion.

Chinese craftsmen cover the building surfaces with decorative painting. Such paintings have very strong covering capacity which can isolate the wood from rainwater. As some kinds of paint are toxic, the painting is able to prevent the wood from insects. (pic 9)

Architectural ornaments of Chinese traditional architecture represent hierarchy. For instance, decorative painting can only be used on buildings of the emperor's family, nobilities and important public buildings. These forms were forbidden to be used by the common people. Even for specific patterns and themes of decorative painting, there were strict rules. For instance, the painting with the dragon and phoenix image could only be used by the emperor's family. If a minister used the image without permission, he might

be killed by the emperor. There were also strict rules for using other architectural decorations, including tou-kung, style and colour of the roof, and the numbers of beasts on the eaves of the roof, etc. In brief, Chinese architectural ornaments were not only used to beautify architectures, but as a way to strengthen the concept of hierarchy. (pic 10)

Part 2

Next, I will introduce two major structures of Chinese timber-frame architectures; namely post-and-lintel structures and column-and-tie-beam structures.

This picture shows a typical post-and-lintel structure which consists of a column, beam, purlin, rafter and a transverse tie-beam, etc. The most distinctive feature of this kind of structure is to build beams on columns, short columns on beams, and shorter beams on short columns, up to the top of the roof in this way, thus getting a set of timber frames. Between two parallel frames, a transverse tie-beam is used for connection. Several purlins are built at the end of beams to connect architectural elements and to bear the load of the roofing. In this structural system, it is the beam that bears the load of the roof and transmits the load to columns. Therefore, the architectural elements of post-and-lintel structure are bulky. The span of beam can reach to 4-6 metres. The greatest advantage of the post-and-lintel structure is that a large inner space can be saved as not many indoor columns are used. What is more, the bulky architectural elements make

the architecture solemn and gorgeous. That is why nearly all Chinese traditional government buildings and dwellings in northern part of China are built with this structure. (pic 11)

This picture shows a typical column-and-tie-beam structure. It is hard to find the difference between this structure and the post-and-lintel structure at first glance. The major difference between the two structures lies in the position of the purlins. In the column-and-tie-beam structure, it is the column that carries the purlin directly, without using beams. Therefore, architectural buildings with column-and-tie-beam structures are built with small and thin architectural elements, even without big wood. As many columns are used to bear load, the inner space of this kind of architecture is comparatively small. This type of structure is popular in the southern part of China. (pic 12)

This structure is also called a “standing-up frame”. When building a house, the workers will set groups of timber frame first, then pull the timber frame up and connect them with the tie-beam. (pic 13)

Part 3

Now, I'd like share with you some ideas on safeguarding traditional craftsmanship based on some projects that I was involved in.

The first case is the restoration of Xiangyun Pavilion in the Forbidden City. As I've mentioned, the Forbidden City is a royal palace composed by courtyards in different sizes. Xiangyun Pavilion is built in a small courtyard located in the west of the palace. It was burnt in a big fire in 1924. While its restoration didn't start immediately, since the foundation of the Peoj57

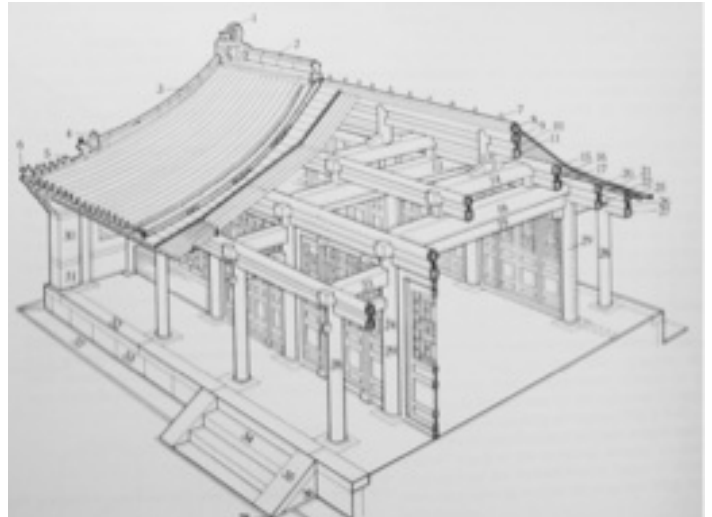

Pic 11: Post-and-lintel structure
14-three-purlin beam;15-purlin;17-lintel/tie-beam; 18-five-purlin beam; 28-eaves column; 29-external principal column



Pic 12: Column-and-tie-beam structure



Pic 13: Pull the timber frame up

le's Republic of China in 1949, the Chinese government attached more attention to heritage conservation – so the restoration of Xiangyun Pavilion was put forward for several times. However, as the original appearance of the pavilion was not able to be confirmed because of the limited records, the restoration was put aside.



Pic 14: The restoration of Xiangyun Pavilion

At the beginning of this century, records on the pavilion were found out of expectation. This discovery led to the start of the restoration of the pavilion. The whole restoration project started around the year of 2008 when awareness about the safeguarding of intangible cultural heritage was widely recognized. Therefore, the whole restoration project was completed by traditional craftsmanship and with traditional materials. In addition, the whole process of restoration was recorded uninterruptedly on video. It's seldom to see traditional craftsmanship attract so much attention in heritage restoration such as in this instance. I was honoured to join in the project to see the nearly lost traditional techniques recurred in this experimental restoration. (pic 14)

will certainly create a win-win situation. This is also the enlightenment that Xiangyun Pavilion restoration project brings us.

In fact, the protection of traditional craftsmanship is facing great challenges due to three major reasons; namely no job, no earning and no apprentice. So the combination of traditional craft protection and cultural relic protection

The second example, I'd like to talk about the safeguarding of building techniques of ancient drama stage in Leping in Jiangxi Province.



Pic 15: Jiangxi Leping traditional stage

Leping is a small city in the south of China. Like many other cities, traditional culture of Leping is well preserved. As local people are particularly interested in Jiangxi drama, more than 400 traditional stages have been built in the city. (pic 15)

However, in recent years, there are some problems in building these stages. For instance, some stages are built with reinforced concrete structure and some stages are decorated with Western featured elements. Though people here are very passionate about building drama stages, some of their actions are reasonless. Therefore,

as our suggestion, local government formulated a series of work plans, including strengthening publicity about traditional culture, academic research and technical training. This year, Leping traditional stage construction technology was inscribed on the Representative List of National Intangible Cultural Heritage. The great attention attached by the local government is an important attribution to this achievement.

By introducing this case, I want to say that whatever the preservation condition of a traditional craftsmanship, the government shall pay attention to its development and provide guidance if necessary. Of course, the guidance does not mean mandatory intervention. It shall be provided by means like publicity, education and training, etc.



Pic16: A Lele cart

The third example, I would like to talk about is the making of a Lele cart (a kind of Mongolian-style ox cart). Lele cart is a kind of traditional vehicle in Mongolia. Mongolians are mainly resident on the grassland in

the northern part of China and a nomadic lifestyle is their traditional way of living. In the past, Mongolians moved periodically according to the changing seasons and the growth of pasture. The Lele cart is their main vehicle for moving around. (pic 16)

Nowadays, a large number of herdsmen have begun to settle. Moreover, the Lele cart is gradually being replaced by modern cars. Influenced by these two factors, it is quite difficult to protect and inherit the building techniques of the Lele cart.

To protect endangered craftsmanship, we have to take rescue measures. To make a comprehensive record of the intangible cultural heritage in words, pictures and videos is the most simple and efficient way. We shall then have a sense of urgency to protect them. The earlier we take moves, the more precious cultural heritage we can save. In the safeguarding of ICH, the Chinese National Academy of Arts has made great efforts. For instance, we have set up files for a dozen of the best representatives of traditional building skills; published relevant research books; and made a plenty of animations to assist our studies.

From the three examples above, we know that the inheritance situation of intangible cultural heritages is various. Therefore, we cannot treat different situations in the same manner. We need to make specific and targeted strategies. Now, my lecture is coming to an end. I hope that my experience may be helpful to you.

Thanks!

Annex IV

Outcomes Statement

Preamble

We, the participants of the regional Workshop on Revitalizing Indigenous Architecture and Traditional Buildings Skills in the Pacific, have convened to share our unique perspectives and collaborate on a vision for the future. We recognize that our traditional buildings and associated building skills are declining in prevalence due to many factors – both environmental and social. We agree that our indigenous architecture is central to the preservation of our unique cultures and in urgent need of safeguarding due to climate change and an increasingly globalized Pacific.

Our indigenous architecture is rich with opportunities, both to utilize the resilient, climate-appropriate design of our traditional buildings and to preserve our cultural identity and traditions. In order to achieve integrated safeguarding we must establish training, research and networking that is both multidisciplinary and intergenerational. By taking this approach, we can greatly enhance the revival of indigenous architecture and traditional building skills of our Pacific people.

Summary of Agreed Actions

In light of the vulnerable state of traditional architecture and building skills in the Pacific, and as a result of the presentations and discussions that have occurred during this workshop, we present the following formal recommendations:

To National Governments

1. Strengthen qualification/accreditation and TVET programmes for the recognition and advancement of Master Builder skills.
2. Provide land for environmental initiatives to revive replanting of raw materials needed in traditional house building.
3. Support the establishment of a “*Tufuga Association*”
4. Provide *tufuga* with subsidies and other incentives to continue traditional building and transmission of their knowledge to young people.
5. Ensure efficient coordination through the establishment of inter-ministerial committee.
6. Nominate traditional house building skills for international recognition by the ICH Convention.
7. Establish a learning centre for traditional arts and crafts skills, inclusive of indigenous architecture.
8. Support awareness raising activities, such as festivals, media campaigns, exhibitions and village consultations.
9. Develop culture policy related to ICH safeguarding.
10. Expand national building code frameworks and regulations to include varied and evolving traditional buildings.

11. Create an integrated safeguarding model inclusive of language, materials, technical skills and the transmission of knowledge to ensure the long term sustainability of Pacific building traditions.
12. Support traditional architecture by highlighting its disaster-resilient nature and linkage to national development plans.
13. Involve communities and districts by instituting local committees to establish model *fale* (s) in each village and ensure frequent community-supported maintenance.
14. Continue and strengthen mapping and community-based inventory making programmes of *tufuga* and remaining traditional architectures.
15. Continue development of understanding and of policies related to intellectual property of traditional designs and knowledge

To the Private Sector

1. Provide sponsorship for awareness raising programmes on ICH, inclusive of indigenous architecture.
2. Establish partnership with the tourism sector to increase employment opportunities for builders.

To Regional Agencies

1. PIF to recognize a "Tufuga Association" inclusive of master builders of traditional homes.
2. PIF to provide support for environmental programmes, such as the replanting of native trees and grasses.
3. PIF to promote traditional building practices to enhance community well-being within the framework of social and educational development programmes.
4. SPREP to support replanting and safeguarding of natural resources necessary for traditional house building.
5. SPC to provide technical cooperation for the revitalization of traditional house building skills through training, policy development, implementation and monitoring, as part of a culture industry development portfolio.
6. SPC to continue to monitor development of international treaties on traditional knowledge and expression of culture by World Intellectual Property Organization.
7. USP to promote research, documentation/archives, and tertiary curriculum development relevant to ICH safeguarding, inclusive of indigenous architecture.

To CRIHAP

1. Provide assistance in organizing training workshops in other sub-regions of the Pacific.
2. Provide fellowship for young people to build capacity for ICH safeguarding.
3. Training of government officials in cultural policy development.
4. Training of *tufuga* in facilitating knowledge transmission of their building knowledge and skills.
5. Provide travel grant for a regional delegation of *tufuga* to the Festival of Pacific Arts.

To UNESCO

1. Provide support for the organization of a multi-stakeholder workshop on the ICH convention in non-state-parties.
2. Provide financial assistance under ICH Fund in the preparatory works to inscribe indigenous house building skills in the Pacific, including inventory making.
3. Promote best practice of safeguarding ICH through an integrated approach that encompasses language, materials, technical skills and the transmission of knowledge.
4. Establish roster of specialists/consultants in indigenous architecture and traditional house building skills.

Annex V

Web Article

A promising future for traditional buildings and skills in the Pacific region

The five-day Pacific regional workshop to discuss and share ideas on best ways to revitalize indigenous architecture and sustainable building skills concluded on 7th November.

The workshop was closed with a presentation of the Outcomes Statement in a media conference and the awarding of certificates to participants by UNESCO Director Etienne Clement and Deputy Director-General from CRIHAP Zhang Jing.

Held at the Samoa Tradition Resort in Apia, the workshop enabled the sharing of perspectives from representatives of Fiji, Tonga, Niue, Samoa, Cook Islands and New Zealand, as well as from experts from China and Japan, on their respective traditional buildings and skills. They discussed the functions of different indigenous architecture, the role these buildings have in society, and the present state of their safeguarding.

These Pacific island countries came together because of a concern that these traditional skills and knowledge are slowly disappearing, despite their great cultural significance, due to globalization, natural hazards including climate change, and a lack of effort to protect these skills and structures.

This workshop has established a common ground for the Pacific Islands to share their unique perspectives and collaborate on a vision for the future, as expressed in their Outcomes Statement:

“Our indigenous architecture is rich with opportunities, both to utilize the resilient, climate-appropriate design of our traditional buildings and to preserve our cultural identity and traditions.”

Bearing in mind the concern over the disappearance of the building skills and knowledge, the Outcomes Statement also recommended an integrated approach to safeguarding that includes the raw materials, structures, language, and traditions associated with indigenous architecture. This will be accomplished through informal and formal trainings, policy-making, awareness-raising, research and networking.

Loli Tuisavalalo, a *tufuga fau fale* or master builder of the Samoan *Fale*, told the conference that during his school days, one day was dedicated to traditional arts and crafts. It was that programme that instilled in him the passion, knowledge and skills that has made him a *tufuga* until today. He believes it is important we provide the same opportunities for young people.

The Outcomes Statement also presents a collective call for support from national governments, regional agencies, and the private sector, as well as to the UNESCO and CRIHAP (Centre for Intangible Cultural Heritage in the Asia-Pacific Region under the auspices of UNESCO) who have a mandate to safeguard cultural heritage.

This workshop is being conducted by the Ministry of Education, Sports and Culture with funding from the CRIHAP and the technical assistance of the UNESCO Office for the Pacific States.

Annex VI

General Information



Workshop on the Revitalization of Indigenous Architecture and Sustainable Building Skills in the Pacific

APIA, SAMOA 3rd – 7th November, 2014

GENERAL INFORMATION

PURPOSE

In consideration of the South Pacific region's specific needs, to help the region strengthen its capacity for safeguarding intangible cultural heritage and realizing sustainable development of its intangible cultural heritage, the *Workshop on the Revitalization of Indigenous Architecture and Sustainable Building Skills in the Pacific* (hereinafter referred to as "the Workshop") was organized between November 3 to November 7, 2014 in Apia, Samoa.

By focusing on the issues including present situation of safeguarding and transmission of indigenous architecture and sustainable building skills in the South Pacific region, challenges encountered in preserving these skills, and feasible ways for the revitalization and sustainable development of the skills, the Workshop strives to establish a platform for enhancing communication and cooperation among practitioners, inheritors, and researchers concerned.

Furthermore, the Workshop is expected to be a driver for better safeguarding and transmission of indigenous architecture and building skills in the South Pacific region.

WORKSHOP ORGANISER

The workshop has been organized by CRIHAP and the Ministry of Education, Sports and Culture and will be held in Apia at the Traditional Hotel and the Samoa Culture Centre.

Please find below the contact details for the individuals in charge of the workshop for any major issues:

For any information queries regarding the workshop, please contact the coordination committee at the following email address: www.mesc.gov.ws

Coordinators

Contact person:

Mrs Peone F. Solomona

Office phone: 64609

Mobile: 7779566

Email: p.solomona@mesc.gov.ws

Person in charge of content:

Ms Lumepa Apelu

Office phone: 685 26036

Mobile: 7284945

Email: l.apelu@mesc.gov.ws

Person in charge of logistics:

Mr Nanai Saolotoga R Fasavalu

Office phone: 685 64628

Mobile: 7626029

Email: s.fasavalu@mesc.gov.ws

PARTICIPANTS AND REGISTRATION

Participants

The main participants of the workshop are the 10th Regional Pacific countries as approved and discussed by the CRIHAP and the Ministry of Education, Sports and Culture i.e. ; Niue, Cook Islands, Tahiti, Tokelau, Wallis and Futuna, Tuvalu, Tonga, American Samoa, New Zealand and Fiji.

Nomination is open to one participant per country with a formal approval letter from the employer to be sent to the coordinators prior to the closing registration date.

Registrations

Please note that all requests to participate in the workshop must be submitted to the COORDINATORS emails or contacts given no later than 11th Oct, 2014

Protocol

Samoa is known for its hospitality, hosting and will be in charge of all matters relating to protocol and the treatment of participants travelling within.

Security

Culture Division under the responsibility of the Ministry of Education, Sports and Culture will ensure the safety of all participants of the workshop.

Accommodation

All participants travelling will be staying in the hotel where the venue of the workshop is located and convenient for accessing.

Transportation

The Ministry will provide transport from hotels to pick up from arriving and departing i.e.; Confirmation time depends on air tickets submitted by the workshop organizers.

PASSPORT, VISA AND OTHER TRAVEL INFORMATION

Passport Requirements

International visitors must have a passport that is valid for at least six months before entry into Samoa and can travel inter island on a valid ID card.

Visa Requirements

For all enquiries visas and other formalities required to enter the Samoa, participants are requested to contact directly the Consulate of Samoa within their country.

Flight Tickets

Your tickets are fully funded by the CRIHAP and followed up by the Workshop Organizer.

Medical Insurance

A first-aid service and an ambulance shall be available to participants in case in need but no other medical service shall be provided. Participants are expected to cover the costs of any medical expenses incurred in Samoa.

Therefore, it is strongly recommended that participants take out medical insurance in their home country in order to be covered in Samoa and elsewhere during travelling.

VENUE

You can access the venues for the workshop on site for more details: www.traditionresort.com

INFORMATION ON SAMOA

Samoa is an island country lying in the South West area of the Pacific and it was the first Pacific country to become independent in 1962. The total population is over 200,000 with its economy primarily based on exports, i.e. agriculture, fisheries, forestry and tourism.

Samoa lies between latitude 13o and 15o south; and longitude 168o and 173o west and it consists of two main islands and eight smaller islands. The capital of Apia is on the second largest island where 70 per cent of the population and infrastructure are located in low-lying coastal areas. This population concentration on the second largest island reflects rising sea levels, subsequent coastal erosion, loss of land and properties, and the enforced removal of inhabitants in certain coastal areas.

Samoa, like many other Pacific countries, has unique traditional architectural styles and building skills. These range from traditional houses, canoe construction and even handcrafts to performing arts. A traditional knowledge bill has passed its third reading in the Parliament of Samoa in order to protect and nurture *fa'asamoa* (culture).

Although the country has seen contemporary changes and how its people adapt to the natural changes of climatic evolution, the people's traditional skills have sculptured a path for today and a future for following generations.

RELATED EVENTS

Refer to the workshop programme – FIELD TRIPS.

Annex VII

List of Participants

NAMES	TITLES	COUNTRY
International Experts		
1 ZHANG Xin-An	Chinese architecture expert	China
2 ZHAO Di	Chinese architecture expert	China
3 Kazuhiko NITTO	Senior conservator	Japan
4 Anne Milbank	UNDP Samoa	Samoa/NZ
CRIHAP		
5 ZHANG Jing	Deputy Director-General	CRIHAP China
6 GE Yuqing	Director of the Division of Training	CRIHAP China
7 TANG Haijiao	Training Program Coordinator of the Division of Training	CRIHAP China
Regional Participants		
8 Ngametua Pokino	Executive Officer – Mangaia Island Government	Cook Island
9 Mere Velavela Dalituicama	Senior Officer – Institute of iTaukei Language and Culture	Fiji
10 Tapukitea Rokoletuku	Candidate in the Master of Arts in the Pacific Studies	Tonga
11 Ellen Huggins	Team Member – Heritage New Zealand	New Zealand
12 Lea Lani Kauvaka	USP Lecturer – Faculty of Arts in the Pacific Studies	Fiji
Samoan Participants		
13 Lafoga Kaisala	Vailele	Samoa
14 Michael Faamoana	Vailele	Samoa
15 Sua Falealii Asi	Vailele	Samoa
16 Falesa Sila	Vailele	Samoa
17 Fofoga Tofele	Vailele	Samoa
18 Mema Vaiaso	Vaitele Uta	Samoa
19 Koreti Uesiliana	Vaitele uta	Samoa
20 Saleilua Faauiga	Vaitele Uta	Samoa
21 Ken Talitonu	Vaitele Uta	Samoa
22 Tuli Samoa	Vaitele Uta	Samoa
23 Sale Filipo	Saanapu	Samoa
24 Maulupe Faatali	Savaii	Samoa

Annex VII List of Participants

25	Aso Lemoe	Saanapu	Samoa
26	Ken Young	Saanapu	Samoa
27	Loli Tuisavalalo	Savaii	Samoa
28	Auvele Ioapo	Saanapu	Samoa
28	Luailepou Moni	Saanapu	Samoa
30	Faanu Laufale	Saanapu	Samoa
31	Saili Faasuaga	Saanapu	Samoa
32	Vaaelua Nofo Vaaelua	CEO - MWTI	Samoa
33	Sua Poumulinuku Onesemo	ACEO - PUMA	Samoa
34	John Sitagata	Senior Inspector Officer - PUMA	Samoa
36	Leota Valma Galuvao	A/CEO CMAD - MESC	Samoa
36	Suluimalo Amataga Petaia	CEO - MNRE	Samoa
37	Leituala Kuiniselani Toelupe - Tago	CEO - MWCSO	Samoa
38	Auelua Samuelu Enari	CEO - MCIL	Samoa
39	Leisiolagi Dr Malama Meleisea	NUS	Samoa
40	Prof Leapai Ilaoa Asofou So'o	NUS	Samoa
41	Samoa Utuva	CMAD	Samoa
42	Leilua Likisone Leilua	Modern Samoan <i>Fale</i> Builder	Samoa
43	Fepuleai Sinapi Moli	CEO - SQA	Samoa
44	Tautai Neemia SailiFagalao	Craftsman	Samoa
45	Malama Taaloga Faasalaina	A/CEO Community Services	Samoa
46	Teo Eteuati Sagala	Faleula	Samoa
47	Fanuaea Amela Silipa	A/CEO NARA	Samoa
48	Maulolo Tavita Amosa	Local Samoan Expert / Consultant	Samoa
Samoaan MESC			
49	Peone F. Solomona	ACEO Culture Samoa	
50	Nanai S. Fasavalu	Principal Audio Visual Officer	Samoa
51	Delphina Lee	Principal Culture Officer	Samoa
52	Mainifo Viliamu	Senior Museum Officer	Samoa
53	Keti Tupai	Audio Visual Officer	Samoa
54	Lefau Boris	Senior Culture Officer	Samoa
55	Malologa Fonofaavae	Secretariat	Samoa
56	Ailini Ah Ken Eteuati	Museum Officer	Samoa
UNESCO Office for the Pacific States			
57	Etienne Clement	Director of the UNESCO Office for the Pacific States	Samoa
58	Akatsuki Takahashi	Programme Specialist for Culture	Samoa
59	Mikia Weidenbac	Intern	Samoa
60	Yusuke NiiUN	Volunteer	Samoa

Annex VIII

Workshop Programme

Workshop on the Revitalization of Indigenous Architecture and Sustainable Building Skills in the Pacific

Samoa Tradition Resort, Siusega and Samoan Culture Centre, Falelauniu, Samoa, 3–7 November 2014

PROGRAMME

Time	Day 1 – Monday Nov. 3rd, 2014	Day 2 – Tuesday Nov. 4th, 2014	Day 3 – Wednesday Nov. 5th, 2014	Day 4 – Thursday Nov. 6th, 2014	Day 5 – Friday Nov. 7th, 2014
8:00	Bus leaves MESC Office				
8:30	Traditional Welcome – Ava Ceremony A simple touch of Samoan welcome Registration	Registration	Registration	Registration	Registration
9:00	Prayer: Moseniolo Etuale Etuale – Siusega Catholic Church	Day 1 Recap and Day 2 Agenda Facilitator Delphina Le	Day 2 Recap and Day 3 Agenda Facilitator Lumepa Apelu	Day 3 Recap and Day 4 Agenda Facilitator Lefau Polani Pita	Day 4 Recap and Final Day Agenda Facilitator Peone Fuimaono
	Remarks H.E Li Yanduan <i>Chinese Ambassador</i> Remarks Mr. Etienne Clement <i>Director UNESCO Office of Pacific States, Apia</i>	Presentation 1 Maulolo Tavita <i>Director Samoa Culture Centre</i> The focus of Maulolo's presentation is on the traditional usage of the Samoa fale.	Presentation Ministry of Works – Representative 1 Kazuhiko Nittoh <i>Senior Expert from Japan</i> Traditional Architecture in Japan	Presentation MNRE/PUMA Su'a P. Onosemo <i>Assistant CEO</i>	Presentation 2 USP – Participants <i>Research Outline and Outcome</i> Discussion on Proposal for the Way Forward

Annex VIII Workshop Programme

Time	Day 1 – Monday Nov. 3rd, 2014	Day 2 – Tuesday Nov. 4th, 2014	Day 3 – Wednesday Nov. 5th, 2014	Day 4 – Thursday Nov. 6th, 2014	Day 5 – Friday Nov. 7th, 2014
	<p>Keynote Address</p> <hr/> <p>Matafeo Falanaipupu T. Aiafi Chief Executive Officer – MESC</p>	<p>Presentation</p> <hr/> <p>2 Anne Milbank Project Manager – UNDP</p> <p>The Samoan fale – architectural history including modern variations</p> <p>The focus of Anne’s session will be on the historical development of the <i>fale</i> Samoa and resilience.</p>	<p>Presentation</p> <hr/> <p>2 Akatsuki Takahashi UNESCO Office for the Pacific States</p> <p>Overview of the ICH Convention MNRE/ PUMA</p>	<p>Presentation</p> <hr/> <p>Mr Zhang Xin-An Promoting Indigenous Architecture – a case study from China</p>	<p>Presentation</p> <hr/> <p><i>continued</i></p> <p>2 USP – Participants <i>Research Outline and Outcome</i></p> <p>Discussion on Proposal for the Way Forward</p>
10:00-10:30	Morning Tea & Photo Session	Morning Tea Samoa Tradition Resort	Morning Tea Samoa Tradition Resort	Morning Tea Samoa Tradition Resort	Morning Tea Samoa Tradition Resort
10:30	<p>Country Report</p> <hr/> <p>The participants from the region were invited to speak with the objectives to mention challenges and current development of traditional building in their countries</p> <ul style="list-style-type: none"> • Cook Islands – Mr Ngametua Pokino • Fiji – Mere Velavela Dalituicama • New Zealand – Ellen Higgins • Samoa – Mata’afa Elia Autagavaia 	<p>Panel Discussion</p> <hr/> <p>Panellists Loli Tuisavalalo Tufuga Seloti Maulupe Faatali Taii Tulei Luaipou Mani</p>	<p>Presentation</p> <hr/> <p>Discussion 1 Facilitated by NanaiSa’olotoga <i>Dis/Advantages of Traditional Houses and House Building Skills</i></p>	<p>Presentation</p> <hr/> <p>MNRE – MET Division Sani seuseu</p> <p>Discussion 2</p> <hr/> <p>Facilitated by Delphina Lee Traditional v Modern? Traditional Building Skills for a Modern Living</p>	<p>Group Presentations – Of Group session Achievements</p> <hr/> <p>Press Conference</p> <hr/> <p>MESC CRIHAP UNESCO</p>

Time	Day 1 – Monday Nov. 3rd, 2014	Day 2 – Tuesday Nov. 4th, 2014	Day 3 – Wednesday Nov. 5th, 2014	Day 4 – Thursday Nov. 6th, 2014	Day 5 – Friday Nov. 7th, 2014
		Video Presentation Q & A	Groups Session 2 Why revitalize Traditional Building Skills? Presentation of Results	Presentation Mr. Zhao Di Chinese Expert Groups Session 3 How to revitalize Traditional Building Skills?	Practical session 4 <u>Master builder/ trainer</u> Thatched Roof
12:30	LUNCH BREAK Samoa Tradition hotel	LUNCH BREAK Samoa Culture Centre	LUNCH BREAK Samoa Culture Centre	LUNCH BREAK Samoa Culture Centre	CLOSING CEREMONY
1:30	Continue Country Reports • Tonga – Mrs Tapukitea Lolomana'ia • Niue - Chad Q & A	Practical session 1 <u>Master builder/ trainer</u> Materials and Tools for Traditional House building – including the production of sennet	Practical session 2 <u>Master builder/trainer</u> Foundations of a House	Practical session 3 <u>Master builder/ trainer</u> Wooden constructions	Closing Prayer Closing Remarks: CRIHAP, UNESCO Presentation of Certificates to Participants
2:00- 2:30	AFTERNOON BREAK	AFTERNOON BREAK	AFTERNOON BREAK	AFTERNOON BREAK	
2:30	Orientation Guided tour This tour aims to look at the existing structures of Samoan <i>fale</i> -inspired architecture and to equip participants with an overview of Samoa's traditional/ modernized structures and their use. Excursion • Museum Exhibition • Government House Mulinu'u • Matai'a's residence Vaimoso • Samoa Tourism <i>Fale</i> • Visit to view traditionally built <i>Fale</i> in Samoa (at the Tiapapata Art Centre, Apia)	Group Session 1 What elements of house building need to be safeguarded?	Group Session 3 How to revitalize traditional building skills?	Group Session 4 Proposal of <i>"Asia-Pacific recommendations on sustainable building skills"</i>	<i>continued</i> Presentation of Certificates to Participants
	Recap & Wrap-up Day 1	Recap & Wrap-up / Day 2	Recap & Wrap-up / Day 3	Recap & Wrap-up/ Day 4	FAREWELL COCKTAIL
6:30	Welcome Dinner				

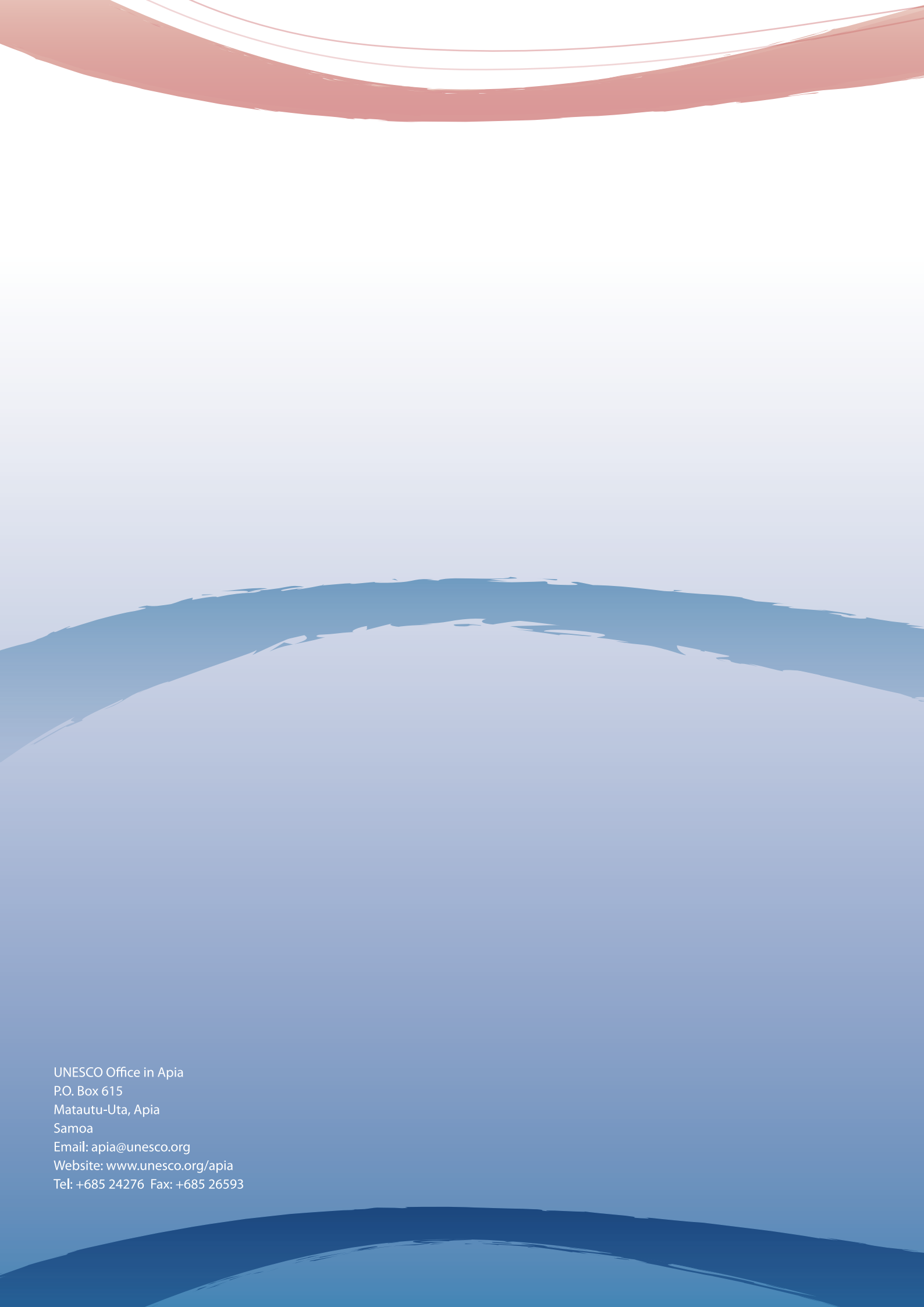

UNESCO Office in Apia
P.O. Box 615
Matautu-Uta, Apia
Samoa
Email: apia@unesco.org
Website: www.unesco.org/apia
Tel: +685 24276 Fax: +685 26593