

# Skills for Life +

Appropriate Technology for Children and Youth  
in Emergencies

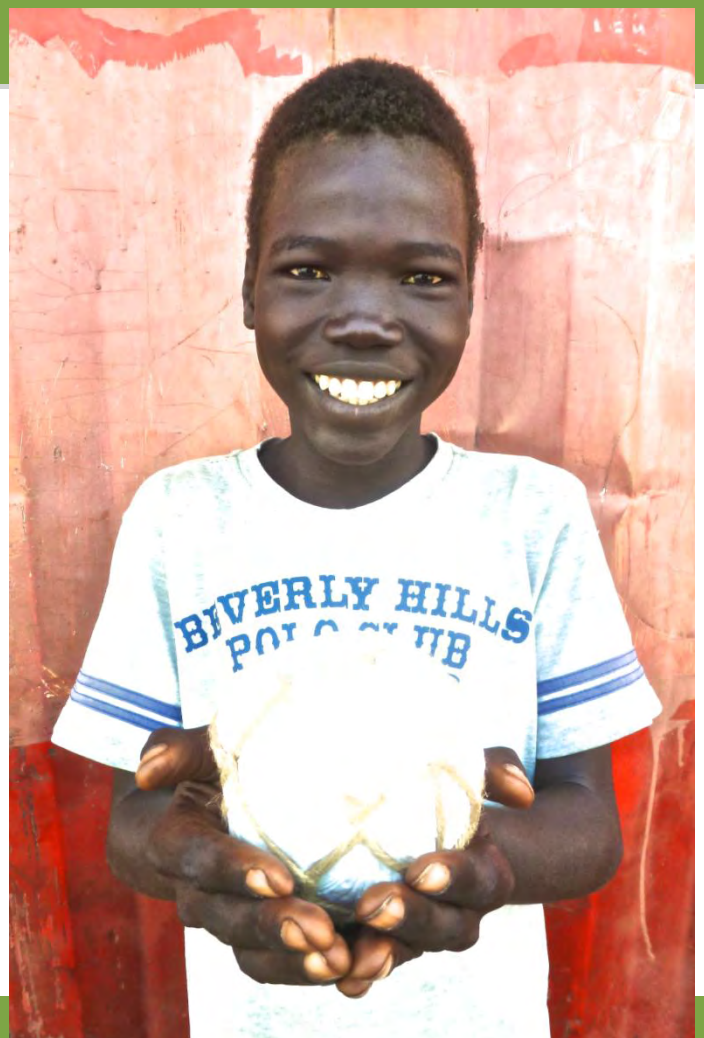

## Teacher Guide



South Sudan  
Education Cluster



United Nations  
Educational, Scientific and  
Cultural Organization

# Acknowledgements

The Ministry of Education, Science and Technology (MoEST), the South Sudan Education Cluster and UNESCO would like to acknowledge all those who assisted in the design, development and piloting of the Skills for Life + Toolkit, including the Education Cluster and all contributing partners. UNESCO also extends appreciation to Sue Nicholson, Hannah Snowden, Renee Christensen, and Rena Deitz for developing, managing and producing the Skills for Life+ materials and project.

In addition to input from field-based project staff, the ideas presented in the Skills for Life + sessions are adapted from a variety of sources, including:

- Send a Cow Lessons from Africa [sendacow.org.uk](http://sendacow.org.uk)
- Swiss Federal Institute for Aquatic Science and Technology (Eawag)
- Jong Chool Do [www.youtube.com/watch?v=QDgAuVK1Br0](http://www.youtube.com/watch?v=QDgAuVK1Br0)

Any misrepresentations of these sources are attributable solely to the authors of this guide.

*Cover photo Gisma and Okello, students at Mahad IDP school, Juba supported by IBIS.*

# CONTENTS

INTRODUCTION	4
How to Use the Toolkit	6
Methods in the Toolkit	8
Group Management	9
Session 1: Safety and Materials	11
Session 2: Funnel, Scoop and Pot	22
Session 3: Container Stool	34
Session 4: Plastic Bag Ball	43
Session 5: Jump Rope	58
Session 6: Water Bottle Light	70
Session 7: Healthy Water	91
Session 8: Tip-Tap	110
Session 9: Toy car	128
Session 10: Water Bottle Mouse Trap	150
Skills for Life + Learner Evaluation	163
ANNEX: South Sudan Teachers' Code of Conduct for Emergency Situations	165

# Introduction

The Skills for Life + Toolkit helps teachers give children and youth information and skills to make things using appropriate technology that will help them during emergencies. The Skills for Life + Toolkit contains:

1. Skills for Life + Teacher's Guide to instruct the teacher
2. Picture charts
3. Picture stories
4. Skills for Life story book

The Skills for Life Toolkit + was developed for teachers with limited English skills who may have to translate into mother tongue or Arabic. The language has been kept simple.

## Important words

- life skills: the skills and knowledge we need to live healthy lives
- psychosocial support: the help we need to live happy and healthy lives
- emergency: when something serious, dangerous and unexpected happens
- appropriate technology:  
technology that is suitable for the place in which it will be used, usually involving skills or materials that are easily available in the local area
- recycle: using discarded items for a new purpose

## What is appropriate technology?

Appropriate technology is a technology that is simple to use, is suitable for the place in which it will be used and culturally sensitive. It involves using skills and materials that are easily available in the local areas so that it is cost effective. In Skills for Life +, the items constructed are simple and use materials that are no longer useful like discarded bottles and plastic bags. These items are reused or recycled to make things that are needed. The tools required and materials are low cost and the things made can make a significant difference in the lives of people.

## What are Skills for Life?

Skills for Life are the skills and knowledge we need to live healthy lives. This means being physically healthy, emotionally healthy and mentally healthy. Everyone needs help to live happy and healthy lives. This is called psychosocial support. It is especially important during an emergency. An emergency is when something serious, dangerous and unexpected happens like armed conflict or a natural disaster like flooding. During emergencies, children, youth and adults feel more vulnerable than normal and need help.

The Skills for Life + Toolkit shows teachers how to conduct lessons using appropriate technology to make items that can support learners to live a healthy and happy life.

## **How do we educate young people during emergencies?**

Children and youth who have experienced conflict or natural disasters have a right to education and protection. Education gives a sense of stability during emergencies. Education can save lives by providing physical protection from dangers and exploitation during emergencies. Education also provides hope for the future. By teaching key survival messages and ways of self-protection, children and youth will cope better in an emergency and stay healthy and safe.

This guide includes a series of activities that help young people to gain new skills quickly. They are teaching materials that can help schools to continue functioning during and after an emergency.

## **Why is the role of teachers important during emergencies?**

Teachers play an important role in children's lives. They can listen to children's problems, help them to make good choices and develop their communication skills. Teachers can help children learn through fun activities. These activities reduce the stress children feel during and after emergencies. Teachers can also be good role models for their learners during a difficult time in their lives.

## **Teacher Support**

In an emergency, even experienced teachers have difficulty coping with new challenges. Remember that there are ways to address stress that help you to teach and support your learners. Also remember that when the learners are participating in an activity and learning, they are much easier to teach.

# How to Use the Toolkit

This Teacher's Guide is written for teachers with limited or no experience of appropriate technology or vocational education. The teacher does not need to be an expert on the topics to teach children useful skills to make things. This guide has sessions on how to make the following items:

1. Safety
2. Scoop, funnel and pot
3. Stool
4. Plastic bag ball
5. Jump rope
6. Water bottle light
7. Healthy water
8. Tip-Tap
9. Toy car
10. Mouse trap

This guide focuses on developing technical skills in learners using recycled or waste items. It also teaches relevant science, mathematical and literacy skills. It is good to use the learners' first language, or mother tongue, to introduce ideas and give directions when teaching this material. This will help them understand what you are saying and make the connection between their language and new English words.

In the first session, ask the class which language is best to speak: English, Juba Arabic or a tribal language.

## Before the Session

Being well organised and prepared is very important. It helps you feel confident and ready to teach. Before the lesson, read the pages you want to teach in the Teacher Guide. Check that you understand what to do.

As you review the sessions you will notice that you need to collect and prepare some teaching materials for the activities. These include word and number cards, materials for science experiments and the recycled materials. Look at the activities carefully and practice making the item. It is very important that you collect the recycled materials you need and organise them before you begin teaching the lesson.

The boxes at the side of the page of the Teacher Guide list and explain the words and materials used in the session. The teaching ideas provide you with extra tips to teach the step or activity.

To teach the Skills for Life + session you will need the Skills for Life + toolkit, some of the Skills for Life for Children picture charts, paper, marker pens and the specific recycled items for that session.

## **Beginning the Session**

Greet the learners and ask questions about the last session. For example, you can ask:

- What did we learn in the last session?
- What did you tell and show your family?
- Can you tell the class about it?

## **Follow the instructions in the Teacher's Guide for teaching the session.**

## **During the Session**

Remember to speak slowly, be clear and stop and allow time for the group to ask you questions. If learners are not able to see the items or your hands clearly when you are making something, repeat the actions again and explain what you are doing.

## **Ending the Session**

Check what the class learned using the questions in the assessment activity.

- What 2 things did you learn today?
- What did you like doing best?
- What will you tell and show your family about today?

Ask some groups to share their answer with the class and thank learners for participating. Remind learners that they can ask you questions if they do not understand anything.

Teachers also need to think about the session and what went well. After each session, ask yourself the following questions:

- What went well in the session? Why?
- What would I do differently next time? Why?
- Which part of the session did the learners seem most interested in? Why?
- Which part of the session did the learners seem least interested in? Why?

Reflecting on each session will help you make changes to improve later sessions.

## **Flexibility in the Session**

Each session contains 7-15 activities. Some activities take longer than others. As the teacher, you manage the time for the activities based on the abilities of the learners. Different learners and different classes learn at different speeds. If you go too quickly, learners may be angry that they cannot finish. If you go too slowly, learners may become bored or disruptive. This Teacher Guide does not give timings for each session, as it is up to you. If you do not have enough time in one lesson to finish all the activities, continue in the next lesson. Remember to repeat the introduction and message.

## Tips for Managing Time

- Begin on time and finish on time. If the learners think they will miss something, they will make the effort to arrive on time.
- Make sure you have the learners' attention before you start. Ask questions and tell stories only when everyone is quiet.
- If learners like an activity, repeat it in later sessions.
- Keep the classroom tidy and put any materials back in their correct place so you can easily begin activities.
- Tell learners the instructions before making groups.

# Methods in the Toolkit

## Key Messages

Each session has a key message – this is a summary of the most important information for learners. It is important that the learners understand this message. It will remind them of the skills they have learned and the behaviour they should practice. Repeat the message as much as possible. Put the key message into a song to help learners remember it. You can also say the message in a low voice followed by a high voice or a quiet voice followed by a loud voice.

## Picture Charts

A picture chart is used in most sessions. Hold the picture chart so all the learners can see it. Ask the questions in the Teacher's Guide. Give learners time to look carefully at the picture and answer each question. If the learners do not know the name of something in the picture, teach them how to say it.

## Picture Story Chart

Stories are used to explain ideas and bring the session to life. Practice reading the stories aloud before you use them in the session. Make sure the learners are quiet before you begin telling the story. Show the first picture so that all learners can see. Follow the directions in the Teacher's Guide when telling the story.

## Working Together

We use pair and group work so that learners practice talking about their ideas before they are discussed in a large group. We also use group work when we make items. Each group needs to share the tools and make the item step by step so each person has a turn. It helps learners become more confident using tools and making things.



## **Role Plays**

We let learners role play so they can act out stories using their own words. This helps them relate the topic they are learning to their own lives. Most learners enjoy role plays. Make sure there is enough space to perform the role play or go outside.

## **Demonstration**

When we show learners how to do something, it is called a demonstration. When demonstrating, you are talking at the same time as showing what to do. Ask the learners what you are doing and listen to their answers. Make sure learners can clearly see your hands and the items you are working with.

## **Games**

Games are a fun way for learners to use the items they have made. The instructions for the games are given in the Teacher's Guide.

## **Assessment**

The assessment activity at the end of each session checks what the class has learned. You can use it to make sure they have not misunderstood any of the information during the session.

# **Group Management**

## **Pair work**

Ask learners to turn to the person next to them. This person is their partner.

## **Forming Groups**

Several activities in each session use small groups. Small groups of 4-6 learners are best because they give everyone a chance to talk and practice making the item.

For groups containing 6 learners, choose 6 learners sitting next to each other. If you have desks in your class, ask 3 learners to turn around and work with the 3 learners behind them.

## **How to Ask Questions**

- Ask short, clear questions. (Most questions are provided for you in the instructions, but you can also ask your own!)
- Use language and vocabulary the learners can understand.

- Ask questions to the entire class. Pause for a few seconds before you choose a learner to answer. In this way, the whole class thinks about the answer in case they are chosen by the teacher.
- Ask several different learners the question to get different ideas.
- Use learners' names when asking them to answer questions.

## **Tips for Managing Discussions**

- Praise learners for good ideas and behaviour.
- Help guide wrong ideas by asking questions.
- Make sure learners raise their hands to answer a question instead of shouting out.

## **Tips for Managing Conflict**

When learners disagree, some conflicts may arise. As a teacher, it is important to make learners feel you are fair.

- Set group rules together.
- Do not make fun of learners' comments.
- Do not tell learners their comments are wrong. Say, "I understand your opinion. Have you thought about...?"
- Use a game to reduce tension and build group harmony.
- Do not put learners who have conflicts in the same group.
- If you notice a learner who tries to disrupt the session, talk to them alone about the problem at the end of the session.
- Ask any learners that continue to disrupt the session to leave the room. As Skills for Life + uses tools, all learners need to pay attention so there are no accidents.

## **Important Learning Principles and Practice**

- Know and use learners' names.
- Create a safe learning environment.
- Be friendly and encourage the learners to speak.
- Encourage all the learners to speak, ask questions and share ideas.
- Comment positively on what the learners say and listen carefully.
- Praise learners for their efforts.
- Do not stop a learner from speaking if they say something incorrect. Allow them to continue and thank them for sharing.
- Encourage all learners to give an answer and take part in the discussion.
- Remember that learners may not have experience with a topic. Role plays or stories can substitute for real-life experience.
- Encourage humour and use games so that sessions are participatory and fun!

# Session 1: Safety and Materials

**Message:** Safe space, safe body, safe tools

## Important words:

**Recycle:** using discarded items for a new purpose

## English

### Vocabulary:

- bottle
- jerry can
- plastic bag
- carton
- milk tin
- bottle top
- paper
- string
- Inner tube
- knife
- nail
- scissors
- razor blade
- marker
- toolbox

### English Phrases:

This is a \_\_\_\_\_  
Find the \_\_\_\_\_

## Activity 1: Introduction

1. Say:

- Today we are going to learn about the Skills for Life Plus programme.
- We will also prepare for the next lessons in Skills for Life Plus when we make useful items to help us become healthier and learn better in class.

## Activity 2: About Skills for Life Plus

1. Say:

- Skills for Life Plus has lessons on making useful items to help us in our daily life. The items will help us lead healthy lives and support us in school.
- Skills for Life Plus will use materials we can easily find around us to make simple machines or other items that we can use at home and in class.

2. Ask:

- What items can we find around us to make things with?
- What do we use to make a tukul? Can we find these around us?

3. Say:

- In Skills for Life Plus we will make things from discarded materials we can find around us.
- Using discarded items will prevent them spoiling our environment.
- These things will help us in our daily lives to feel healthy both in mind and body.
- We will learn how to make a:
  - Scoop, funnel and pot
  - Stool
  - Ball
  - Skipping rope
  - Light
  - Tip-Tap machine to pour water on our hands
  - Healthy water
  - Toy car
  - Mouse trap

**Materials for activity 3:**

Plastic bags

Plastic water bottles

Old paper

Milk tins

Large and small jerry cans

Cardboard cartons

Bottle tops

Pieces of string

Inner tube

## Activity 3: **Materials**

1. Put the learners into a circle.
2. Show the following materials:
  - Selection of plastic bottles
  - Small and large jerry cans
  - Newspaper/old paper
  - Plastic bags
  - Cardboard cartons,
  - Milk tins
  - Sticks
  - Bottle tops
  - Pieces of string
  - Inner tube
3. Ask:
  - What are these?
  - Where can we find them?
4. Say:
  - These materials have been used and thrown away.
  - We can use these materials.
  - When we use them again we say we are recycling the materials.
5. Say:
  - Let's learn the English words.
6. Point to each item in turn and say:
  - This is a **bottle**.
  - This is a **jerry can**.
  - This is a **plastic bag**.
  - This is a **carton**.
  - This is a **milk tin**.
  - This is a **bottle top**.
  - This is **paper**.
  - This is **string**.
  - This is an **inner tube**.
7. Point to the item and ask:
  - What is this?
  - Learners should respond in English: This is a \_\_\_\_\_ .
8. Repeat with 5-10 learners.
9. Select a learner. Say:
  - Find the **bottle**.
  - Find the **jerry can**.
  - Find the **plastic bag**.

- Find the **carton**.
- Find the **milk tin**.
- Find the **bottle top**.
- Find the **paper**.
- Find the **string**.
- Find the **inner tube**.

10. Repeat with 5-10 learners.

## Activity 4: Beat the Words

1. Say the first vocabulary word. Ask the learners to repeat it after you.

2. Say:

- Listen while I clap the syllables in this word.

### Teaching Syllables:

#### Syllables in Vocabulary Words

- **string**: 1 syllable = 1 clap
- **bot / tle**: 2 syllables = 2 claps
- **car / ton**: 2 syllables = 2 claps
- **pa / per**: 2 syllables = 2 claps
- **milk / tin**: 2 syllables = 2 claps
- **jer / ry / can**: 3 syllables = 3 claps
- **plas / tic / bag**: 3 syllables = 3 claps
- **bot / tle / top**: 3 syllables = 3 claps
- **in / ner / tube**: 3 syllables = 3 claps

### Materials for activity 5:

Make large word cards for each of the following words: string, bottle, carton, paper, milk tin, jerry can, plastic bag, bottle top, inner tube

3. Say the word again while clapping the syllables.

4. Repeat with learners.

5. Ask learners to identify the number of syllables in the word.

6. Use your fingers to count the number of syllables together with the class.

7. Repeat with the other vocabulary words.

## Activity 5: Learn the Words

1. Show the word card for **string**.

2. Read the word card and put it by the string.

3. Read the word card **string** again

4. Ask learners to read the word card with you.
5. Repeat for all the word cards.
6. Collect the word cards
7. Show the word card **string** and read the word.
8. Ask a learner to put the word card **string** by the item it describes.
9. Repeat for all the word cards.
10. Collect the word cards again.
11. Show the word card **string**.
12. Ask a learner to read the word card **string** and put it by the item it describes.
13. Repeat for all the word cards.

**Materials for activity 6:**

Collect water, sand, soil, stones and sticks

## Activity 6: Environmental materials

1. Show the following materials:

- Water
- Sand or soil
- Stones
- Sunlight (point to sunlight on the floor or out the window)
- Sticks

2. Ask:

- What are these?
- Where can we find them?

3. Say:

- These materials are around us.
- They are materials we can find.
- We must ask for permission to take these materials before we use them.

## Activity 7: Toolkit

1. Show the materials in the toolkit.

2. Ask:

- What are these?

3. Say:

- These are the tools we will use in the Skills for Life Plus programme.

4. Ask:

- What do we use the scissors for?

**Materials for activity 7:**

Toolkit items:  
scissors, craft knife, nails and marker pen

razor blade

Toolbox:

Small strong cardboard carton,

small milk tin, scissors made from cardboard

knife made from cardboard

- What do we use the knife for?
- What do we use the nail for?
- What do we use the marker for?
- What do we use the razor blade for?

5. Ask:

- What happens if I touch the edge of the scissors?
- What happens if I touch the edge of the knife?
- What happens if I touch the edge of the razor blade?
- What happens if I touch the pointed end of the nail?
- What happens if I touch the end of the marker?

6. Say:

- The edge of the scissors, knife, razor blade and nail are sharp.
- We must take care or we may cut ourselves or someone else.
- It is better to use a scissors and knife. A razor blade is more dangerous to use as it is so small.
- We must keep the tools in a safe place or container.

7. Ask:

- What can we use to keep the tools safe in the classroom?

8. Say and demonstrate:

- We can put the tools flat in a strong cardboard carton.
- We can put the tools in a tin with the blade pointing down.
- We can mark a place to put the tools.

9. Let's learn the English words.

10. Point to each item in turn and say:

- This is a **toolbox**
- This is a **knife**.
- This is a **nail**.
- This is a **razor blade**.
- This is a **marker pen**.
- These are **scissors**.

11. Point to the item and ask:

- What is this?
- Learners should respond in English: This is a \_\_\_\_\_ .

12. Repeat with 5-10 learners.

13. Select a learner. Say:

- Find the **knife**.

- Find the **nail**.
- Find the **razor blade**.
- Find the **marker pen**.
- Find the **scissors**.
- Find the **toolbox**.

14. Repeat with 5-10 learners.

15. Say:

- Listen while I clap the syllables in this word.

### Teaching Syllables:

#### Syllables in Vocabulary Words

- **knife**: 1 syllable = 1 clap
- **nail**: 1 syllable = 1 clap
- **scis / sors** : 2 syllables = 2 claps
- **tool / box** : 2 syllables = 2 claps
- **mar /ker / pen**: 3 syllables = 3 claps
- **raz /or / blade**: 3 syllables = 3 claps

16. Say the word again while clapping the syllables.

17. Repeat with learners.

18. Ask learners to identify the number of syllables in the word.

19. Use your fingers to count the number of syllables together with the class.

20. Repeat with the other vocabulary words.



#### Materials for activity 8:

Make a large scissors from cardboard.

## Activity 8: Classroom Rules

1. Say:

- Before we make anything we must prepare a good space to work in.
- It must be safe.

2. Hold up the chart: **Classroom safety**

3. Ask:

- What can you see in this picture?
- What are the learners doing?
- What are the dangerous things happening in the picture?
- What are the good things happening in the picture?



- Is this a safe classroom space?

4. Say:

- It is dangerous to sleep near tools.
- It is dangerous to hold scissors that are open.
- Leaving bags on the floor is dangerous as we can trip over them.
- Leaning over to collect something is dangerous.
- Small children can distract us.

5. Ask some learners to come to the front. Give them the model scissors made from cardboard.

6. Ask the learners to role play the situations in step 4.

7. After each role play ask:

- Why is this dangerous?

8. Ask:

- What can we do to make the space safe to work in?
- How can we prevent accidents and injuries?

9. Say:

- A safe space has rules that must be followed by everyone.

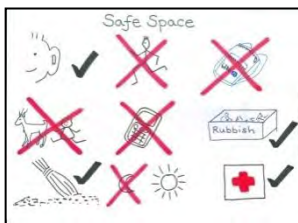

10. Show the chart: **Safe space**

11. Point to each picture in turn.

12. Ask:

- What does this picture mean?

13. Say the rules clearly after each picture:

- Listen carefully and follow instructions.
- Do not run. You could cause an accident.
- Bags stay outside or against the wall so no one trips over them.
- No small children or animals so no distraction.
- No mobile phones so no distraction.
- Use a rubbish bin. A messy space is dangerous.
- Sweep the space clean to avoid slipping.
- Work in good light so you can see well.
- Have a first aid kit nearby.
- Do not use tools when you are tired. Losing attention can cause an accident.
- Make sure windows are secured so they do not stick out into the classroom space. We can hit our head on the window if it is not secured.

14. Ask:

- How will we make our classroom space safe?

- Which place will we use as the work shop space?
- What will we do to make this space safe?

15. Organise the space to make it safe.

16. Read out the key message:

**Safe space, safe body, safe tools.**

17. Repeat with learners.

18. Say the key message to a music beat.

19. Repeat with learners.

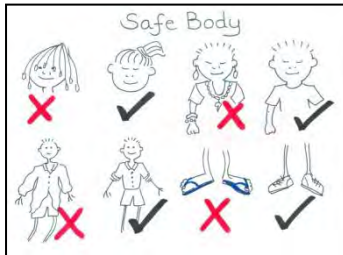

## Activity 9: Learner Rules

1. Say:

- Before we make anything we must prepare ourselves.
- We must be safe.

2. Ask:

- What can we do to make ourselves safe when we use tools?
- How can we prevent accidents and injuries?

3. Say:

- There are rules that must be followed by everyone to make sure we are safe.

4. Show the chart: **Safe body.**

5. Point to each picture in turn.

6. Ask:

- What does this picture mean?
- Why is it dangerous?

7. Say:

- Loose hair, jewellery and clothes can get caught in tools.
- Sandals do not protect our feet if we drop a tool on them. We can trip wearing loose sandals or shoes.
- Loose hair or a scarf will stop us from seeing well. We may push hair or a scarf back when we have a tool in our hand which is dangerous.

8. Ask some learners to come to the front. Give them the cardboard scissors.

9. Ask the learners to role play the situations in step 7.

10. After each role play ask:

- Why is this dangerous?

11. Point to each picture in turn again and Say the rules clearly after each picture:
  - Keep long braids tied back so you can see well.
  - No jewellery. Long earrings, necklaces, bracelets and big rings can catch in tools.
  - No loose clothing. Tuck in shirts and roll up sleeves.
  - Protect your feet – wear strong shoes.
  - Don't wear loose shoes as you may trip over.
12. Say:
  - Let's make ourselves safe.
  - What can we do to make ourselves safe?
13. Move around the learners. Check that they have done everything they can to make themselves safe.
14. Read out the key message:
 

**Safe space, safe body, safe tools.**
15. Repeat with learners.
16. Say the key message to a music beat.
17. Repeat with learners.

**Materials for activity 10:**

Toolkit items: scissors, craft knife, nails and marker pen,

## Activity 10: Skills for Life Plus toolkit

1. Put the learners into a circle.
2. Show the items in the tool kit.
3. Ask:
  - What is this?
  - What do we use it for?
4. Say:
  - We also have rules for using tools.
  - This tool kit only has a few tools but they can still cause injuries.
  - There are rules that must be followed by everyone to make sure we are safe.
5. Show the chart: **Safe tools**
7. Point to each picture in turn.
8. Ask:
  - What does this picture mean?
9. Say the rules clearly after each picture:
  - Close the scissors and the knife. Put in the toolbox when you are not using it.
  - Carry tools with blades pointing down and away from the body.



- Keep hands at the side or behind the tool. Cut away from your body.
  - Pass scissors by holding the closed blades.
  - Move your feet – don't reach.
  - Don't drink from an unknown bottle or one with poison markings.
5. Demonstrate the following:
    - Carry a scissors and knife with the blades pointing down.
    - Closing scissors and a knife and putting in the tool box.
    - Passing scissors.
  6. Ask some learner to show you how to:
    - Carry scissors and a knife.
    - Pass scissors.
    - Put scissors and a knife away.
  7. Pass the scissors safely around the learners in the circle.
  8. Read out the key message:
 

**Safe space, safe body, safe tools**
  9. Repeat with learners.
  10. Say the key message to a music beat.
  11. Repeat with learners.

## Activity 11: Key Message

1. Ask learners if they remember the key message.
2. Write the key message on the blackboard.
 

**Safe space, safe body, safe tools.**
3. Read the message. Move your finger under each word as you read it.
4. Ask learners to say the message with you. Point to each word as you read it together.
5. Ask different learners to read the message.
6. Ask learners to come to the front and underline a word in the message such as: safe, tools.
7. Ask learners to copy the message and draw a picture to go with it.

### Materials for activity 12:

Stones or sticks  
3 pots made from water bottles with a happy, normal and sad face

## Activity 12: Assessment

1. Put learners into groups of 2.

2. Ask each group of 2 learners to talk about the following questions:

- What 2 things did you learn today?
- What did you like doing the best?
- What will you tell your family about today?

3. Ask some groups to share their answers with the class.

4. Say:

- In the next session we will make a funnel, a pot and a scoop.
- We will make them from used plastic bottles.
- Each learner should try to bring 1 or 2 used plastic bottles to the next class.



5. Find three places on the floor or use 3 pots and mark them: happy face, normal face and sad face.

6. Ask each learner to put a stone or stick next to the place that shows how they felt about the session.

7. Write down how many learners put a stone next to each face in order to keep track of which lessons work well and which lessons could be improved.

# Session 2: Funnel, Scoop and Pot

**Message:** Carry tools blade down.

## Important words:

**Scoop:** A tool for picking up rice and flour

**Funnel:** A tool to pour liquid into a small opening

## English

### Vocabulary:

- pot
- half
- quarter
- whole
- three quarters
- plastic bottles
- marker pen
- scissors
- knife
- nail
- rubbish bin

### English Phrases:

This is a \_\_\_\_\_

Find the \_\_\_\_\_

## Materials for activity 2:

Pieces of paper

Scissors

Marker pen

## Activity 1: Introduction

1. Ask

- What did you learn in the last session?
- Can you tell the class about it?

2. Say:

- Today we learn how to use a recycled bottle to make some useful items.
- We will make a funnel, pot and scoop.
- We will also look at how we can divide objects.

3. Ask:

- Who has a bottle?
- What is it made of?

## Activity 2: Maths

1. Ask 2 learners to come to the front.

2. Say:

- I have one piece of paper. I want to share the paper equally between each learner.

3. Ask: How can I share the paper equally?

4. Say:

- I can fold and cut the paper into 2 equal parts.
- We call each part a half.
- Half the paper plus half the paper makes a whole paper.

5. Write on each half of paper  $\frac{1}{2}$ . Say:

- This is how we write a half.

6. Point to  $\frac{1}{2}$  and ask:

- What is this?
- Learners should respond in English: This is a half.

7. Repeat with 5-10 learners.

8. Ask 4 learners to come to the front.

9. Say:

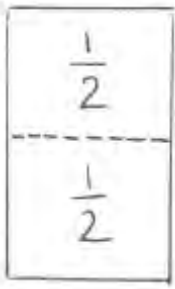

- I have one piece of paper. I want to share the paper equally between each learner.

10. Ask:

- How can I share the paper equally?

11. Say:

- I can fold and cut the paper into 4 equal parts.
- We call each part one quarter.
- 1 quarter plus 1 quarter makes a half.
- 1 quarter plus 1 quarter plus 1 quarter makes 3 quarters.
- 1 quarter plus 1 quarter plus 1 quarter plus 1 quarter makes a whole.

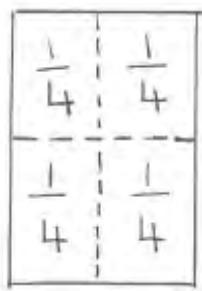

12. Point to a quarter and ask:

- What is this?
- Learners should respond in English: This is a quarter.

13. Repeat for 2 quarters, 3 quarters and 4 quarters.

14. Repeat with 5-10 learners.

15. Write on each quarter of paper  $\frac{1}{4}$ . Say:

- This is how we write a quarter.

16. Ask learners to find the following:

$\frac{1}{4}$ ,  $\frac{1}{2}$ ,  $\frac{3}{4}$ , whole

17. Point to  $\frac{1}{4}$  and ask: What is this?

Learners should respond in English: This is a quarter.

18. Repeat for  $\frac{1}{2}$ ,  $\frac{3}{4}$  and whole.

19. Hold up a plastic bottle.

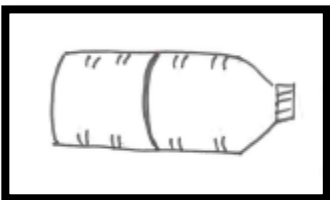

20. Say:

- I want to cut the bottle in half.

21. Draw a line with the marker pen to divide the bottle in half.

22. Show the learners.

23. Ask a learner to come to the front and draw a line marking half on another bottle with a marker pen.

24. Say:

- I want to cut the bottle into 4 quarters.

25. Draw lines with the marker pen to divide the bottle into 4 quarters.

26. Show the learners.

27. Ask a learner to come to the front and draw a line marking another bottle into quarters with a marker pen.

28. Repeat with 5-10 learners.

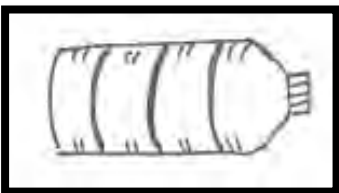

## Activity 3: **Beat the Words**

1. Say the first vocabulary word. Ask the learners to repeat it after you.

2. Say:

- Listen while I clap the syllables in this word.

### **Teaching Syllables:**

#### **Syllables in Vocabulary Words**

- **half:** 1 syllable = 1 clap
- **quar / ter:** 2 syllables = 2 claps
- **whole:** 1 syllable = 1 claps
- **three / quar / ters:** 3 syllables = 3 claps
- **fun / nel:** 2 syllables = 2 claps
- **pot:** 1 syllable = 1 clap
- **scoop:** 1 syllable = 1 clap

3. Say the word again while clapping the syllables.

4. Repeat with learners.

5. Ask learners to identify the number of syllables in the word.

6. Use your fingers to count the number of syllables together with the class.

7. Repeat with the other vocabulary words.

### **Materials for activity 4:**

Plastic bottles

Marker

Scissors

Knife

Nail

Rubbish bin

## Activity 4: **Preparation**

1. Put the learners into a large circle.

2. Say:

- We are going to prepare to make a funnel, a pot and a scoop.

3. Show the items needed to make a funnel, pot and scoop.

- Plastic bottle
- Marker pen
- Scissors
- Knife
- Nail
- Rubbish bin

4. Point to each item in turn and ask:

- What is this?



- Learners should respond in English: This is a \_\_\_\_\_
5. Repeat with 5-10 learners.
  6. Ask:
    - Is the space safe?
    - Is your body safe? Are you dressed correctly?
  7. Remind the learners of the Skills for Life Plus rules.
  8. Ask the learners to make their body and the space safe
  9. Say:
    - We will be sharing tools.
  10. Read out the key message:
 

**Carry tools blade down.**
  12. Repeat with learners
  13. Say the key message to the music beat.
  14. Repeat with learners.

**Materials for activity 5:**

Make large word cards for each of the following words: plastic bottles, marker pen, scissors, knife, nail, rubbish bin

## Activity 5: Learn the Words

1. Show a word card.
2. Read the word card and put it by the item.
3. Read the word card again.
4. Ask learners to read the word card with you.
5. Repeat for all the word cards.
6. Collect the word cards.
7. Show a word card and read the word.
8. Ask a learner to put the word card by the item it describes.
9. Repeat for all the word cards.

**Materials for activity 6:**

Plastic bottles  
Marker  
Scissors  
Knife  
Nail  
Rubbish bin

## Activity 6: Demonstration

1. Say:
  - I am going to show you how to make a funnel, a pot and a scoop.
  - Look carefully at what I do.
2. Say:
  - It is important to put all the waste pieces we don't want in the rubbish bin.
  - Remember: Use a rubbish bin. A messy space is dangerous.
3. Follow the instructions.

4. When you have finished put all the waste pieces in the rubbish bin.
5. Say:
  - Let's learn the English words.
6. Point to each item in turn and say:
  - This is a **funnel**.
  - This is a **pot**.
  - This is a **scoop**.
7. Point to the item and ask:
  - What is this?
  - Learners should respond in English: This is a \_\_\_\_\_ .
8. Repeat with 5-10 learners.
9. Select a learner. Say:
  - Find the **funnel**.
  - Find the **pot**.
  - Find the **scoop**.
10. Repeat with 5-10 learners.
11. Show the word cards. Read the word card aloud and put it by the item.
12. Read the word card again.
13. Ask learners to read the word card with you.
14. Repeat for all the word cards.
15. Collect the word cards.
16. Show a word card and read the word.
17. Ask a learner to put the word card by the item.
18. Repeat for all the word cards.
20. Pass each item around the circle.
21. Say
  - The scoop can also be used as a funnel if you take the top off.
  - If you don't make a good scoop, you can cut it into a funnel.
22. Ask:
  - What can we use the funnel for?
  - What can we use the pot for?
  - What can we use the scoop for?
23. Say:
  - We can use the funnel to direct water from the tap into a jerry can.

**Materials for activity 6:**

Make large word cards for each of the following words: funnel, pot, scoop

- We can use the pot for holding water to drink, or as a soap holder in the place we wash our hands.
- We can use the pot to grow plants.
- We can use the pot to keep marker pens in.
- We can use a pot to keep stones in for assessment.
- We can use a scoop to transfer foodstuffs like flour, rice and beans from a large sack into a small bag.
- We can use a scoop as a measurement when we sell foodstuffs.

24. Pick up each marker pen in turn. Check the top if on correctly and put in the pot.

25. Say:

- We must put the top on the marker pen correctly.
- Don't leave a marker pen without a top on as it will dry out.
- A dry marker pen will not work.

# Water bottle funnel and cup



## Materials:

Water bottle  
Scissors / craft knife  
Marker pen

1. Remove the label from the water bottle. Make sure you use a scissors or knife pointing away from you. Keep your hands away from the scissors or knife.
2. Draw a line with the marker pen around the middle of the bottle. Divide the bottle into 2 equal parts.
3. Hold one end of the bottle.
4. Use a knife to cut into the plastic bottle along the line. Keep the hand holding the bottle away from the knife.
5. When you have made the cut into the bottle, replace the knife in the tool box.
6. Take the scissors and cut carefully along the line. Cut the bottle in half.
7. Now the bottle is cut in half. One half is a funnel. One half is a pot.

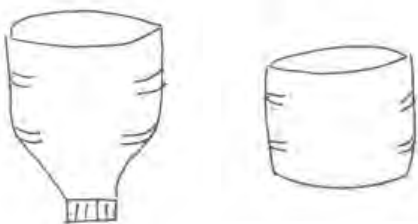
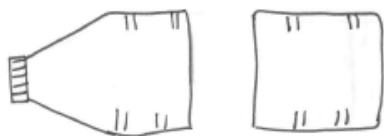
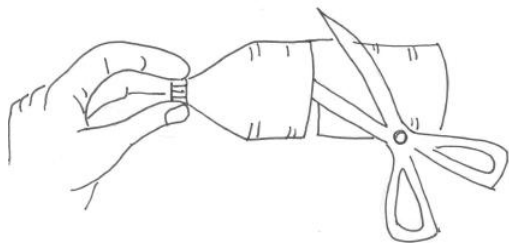
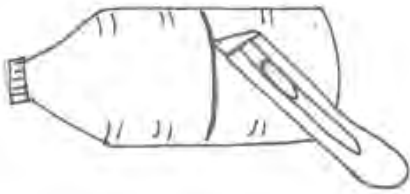
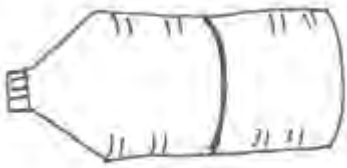

# Water bottle scoop

## Materials:

Water bottle

Scissors

Marker

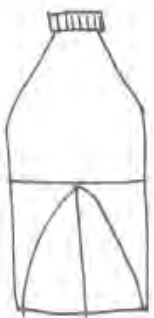
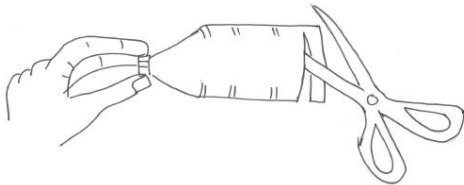
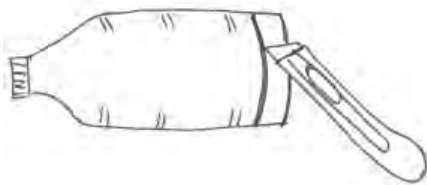
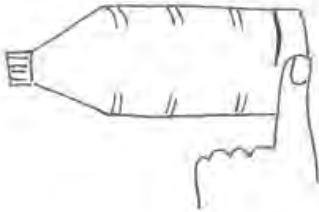

1. Check the lid is on bottle.
2. Remove the label from the water bottle. Make sure you use a scissors or knife pointing away from you. Keep your hands away from the scissors or knife.
3. Draw a line with the marker pen around the bottle one finger width from the bottom.
4. Hold the top of the bottle. Use a knife to cut into the plastic bottle along the line. Keep the hand holding the bottle away from the knife.
5. When you have made the cut into the bottle, replace the knife in the tool box.
6. Take the scissors and cut carefully along the line. Cut the bottom off the bottle.
7. Put the bottom of the bottle in the rubbish bin.
8. Draw a line with the marker pen around the middle of the bottle. Divide the bottle into 2 equal parts.
9. Draw a line from the bottom to the middle of the bottle.
10. Draw the shape of the scoop each side of the line.
11. Use the scissors, cut along the middle line first.
12. Then cut along the scoop shape lines.
13. Now you can have a scoop.



# Water bottle plant pot

## Materials:

Water bottle cup

Nail

Soil



1. Make a pot from a water bottle.
2. Take a nail.
3. Put the pot on some soft earth.  
Hold the nail in your hand inside the pot.  
Push the nail gently through the bottom of the pot.
4. Make 3 or 4 holes.
5. Go outside. Use the scoop to fill the pot 3 quarters full.
6. Plant some seeds or a seedling in the pot.



**Materials for activity 7:**

Plastic bottles  
Marker  
Scissors  
Knife  
Nail  
Rubbish bin

## Activity 7: Demonstration with Learners

1. Say:
  - We will make a funnel, pot and scoop together.
2. Select learners to take it in turns to do one step in the process of making the items.
3. Say:
  - Each learner will do one step of the process.

Monitor the learners carefully.

Check learners keep their hands safe and away from the knife and scissors blade.

Check learner close the knife and scissors when they have finished with them.

Put the tools back in the toolbox.

4. When the learners have finished pass each item around the circle.
5. Thank the learners for using the scissors and knife correctly and safely.
6. Thank the learners for being careful making the items.
7. Read out the key message:  
**Carry tools blade down.**
8. Repeat with learners.
9. Say the key message to the music beat.
10. Repeat with learners.

**Materials for activity 8:**

Tool kit  
Rubbish bin

## Activity 8: Making a Funnel, Scoop and Pot

1. Put the learners into 5 groups.
2. Ask learners to put the bottles they brought on the floor.
3. Say:
  - If your group has a lot of bottles then you can make one item each.
  - If your group only has a few bottles, the group will work together to make one item. Take it in turns to do each step.

4. Give a scissors, knife, nail and marker pen to each group.
5. Say:
  - Each group can make their items now.
6. Monitor the groups and provide help when needed. Make comments to the group:
  - I like the way you are helping each other.
  - I like the way that you are making a good shape.
  - I like the way you are being careful with the scissors.
7. When everyone has finished collect the tools.
8. Ask each group to show their items in turn.
9. Ask:
  - How will you use these items?

## Activity 9: **Key Message**

1. Ask learners if they remember the key message.
2. Write the key message on the blackboard.
 

**Carry tools blade down.**
3. Read the message. Move your finger under each word as you read it.
4. Ask learners to say the message with you. Point to each word as you read it together.
5. Ask different learners to read the message.
6. Ask learners to come to the front and underline a word in the message such as: tools, down
7. Ask learners to copy the message and draw a picture to go with it.

### **Materials for activity 10:**

Stones or sticks  
3 pots made from water bottles with a happy, normal and sad face

## Activity 10: **Assessment**

1. Put learners into groups of 2.
2. Ask each group of 2 learners to talk about the following questions:
  - What 2 things did you learn today?
  - What did you like doing the best?
  - What will you tell your family about today?
3. Ask some groups to share their answers with the class.
4. Say:
  - In the next session we will learn how to make a stool from recycled materials.



- We will need milk tins, large jerry cans and plastic bottles.
- Each learner should try to bring these items to the next class.



5. Find three places on the floor or use 3 pots and mark them: happy face, normal face and sad face.
6. Ask each learner to put a stone or stick next to the place that shows how they felt about the session.
7. Write down how many learners put a stone next to each face in order to keep track of which lessons work well and which lessons could be improved.

# Session 3: Container Stool

**Message:** Plan your work before you start.

## Important words:

**Stool:** A simple seat with 1, 3 or 4 legs.

## English Vocabulary:

- stool
- chair
- bench
- rock
- mat
- wheelchair
- leg

## English Phrases:

This is a \_\_\_\_\_  
Find the \_\_\_\_\_

## Materials for activity 2:

Skills for Life for Children chart set

## Activity 1: Introduction

1. Ask

- What did you learn in the last session?
- What did we make in the last session?
- What did we use to make it?
- What did you do with the items you made in the last session?
- Can you tell the class about it?

2. Say:

- Today we learn how to make a stool from materials we can find around us.

3. Ask:

- Who has a stool at home?
- What is it made of?

## Activity 2: How Many Legs?

1. Hold up the Skills for Life for Children charts.

2. Say:

- We will look at each chart to find what children and adults sit on.

3. Turn to the first chart.

4. Ask:

- Who is sitting?
- What are they sitting on?
- What is it called?
- How many legs does it have?

5. Ask one learner to draw the seat on the board or A4 paper.

6. Repeat for each chart.

7. Say:

- Let's learn the English words.

8. Point to each picture on the board or A4 paper in turn and say:

- This is a **stool**.

- This is a **chair**.
- This is a **bench**.
- This is a **rock**.
- This is a **mat**.
- This is a **wheel chair**.

9. Point to the item and ask:

- What is this?
- Learners should respond in English: This is a \_\_\_\_\_ .

10. Repeat with 5-10 learners.

11. Select a learner. Say:

- Find the **stool**.
- Find the **chair**.
- Find the **bench**.
- Find the **rock**.
- Find the **mat**.
- Find the **wheel chair**.

12. Repeat with 5-10 learners.

13. Use the drawings and ask:

- How many legs on this stool?

14. Ask:

- How many legs make a safe stool?

15. Say:

- When we make a stool, 1, 3 or 4 legs can make a safe stool.
- It takes skill to make a safe stool from wood.
- We can make simple and safe stools from recycled items.

16. Ask:

- Has anyone make a stool from an item they found or was recycled?

17. If a learner has made a stool from recycled items, ask them to describe it.

## Activity 3: **Beat the Words**

1. Say the first vocabulary word. Ask the learners to repeat it after you.

2. Say:

- Listen while I clap the syllables in this word.

## Teaching Syllables:

### Syllables in Vocabulary Words

- **stool:** 1 syllable = 1 clap
- **rock:** 1 syllable = 1 claps
- **bench:** 1 syllable = 1 clap
- **leg:** 1 syllable = 1 clap
- **chair:** 1 syllable = 1 clap
- **mat:** 1 syllable = 1 clap
- **wheel / chair:** 2 syllables = 2 claps

3. Say the word again while clapping the syllables.
4. Repeat with learners.
5. Ask learners to identify the number of syllables in the word.
6. Use your fingers to count the number of syllables together with the class.
7. Repeat with the other vocabulary words.

## Activity 4: Preparation

1. Put the learners into a large circle.
2. Say:
  - We are going to prepare to make a stool.
3. Show the materials needed to make a stool.
  - Large milk tin
  - Large jerry can
  - Soil or sand
4. Point to each item in turn and ask:
  - What is this?
  - Learners should respond in English: This is a \_\_\_\_\_ .
5. Repeat with 5-10 learners.
6. Say:
  - Containers are very useful for storing water and food. They can keep insects and dust out.
  - If a jerry can has a hole it will not be good for water. We can use it to make a stool.
  - Before you use a container, check you have permission from the owner to take it.
7. Ask:

### Materials for activity 4:

Milk tin

Large jerry can

Container of soil or sand

Paper or plastic to cover the floor

- Is the space safe?
- Is your body safe? Are you dressed correctly?

8. Remind the learners of the Skills for Life Plus rules.

9. Ask the learners to make their body and the space safe.

## Activity 5: **Demonstration: Milk Tin**

### **Materials for activity 5:**

Milk tin

Large jerry can

Container of soil or sand

Paper or plastic to cover the floor

Toolkit

Plastic bottles

1. Say:

- I am going to show you how to make a stool from a milk tin.
- Look carefully at what I do.

2. Take the milk tin. Check it has no holes in it.

3. Cover the floor with paper or plastic.

4. Ask a learner to fill the milk tin with soil.

5. Stop the learner if they use their hands to fill the milk tin after a few handfuls of soil.

6. Ask:

- Is this a good way to fill the milk tin with soil?
- What can we use to help us put the soil into the milk tin?

7. Say:

- We can use a scoop to put the soil into the milk tin. We will not get our hands dirty.

8. Ask 3 learners to come to the front. Say:

- One learner will mark and cut the bottom off a plastic bottle.
- The second learner will draw around the middle of the bottle and the shape of the scoop.
- The third learner will cut the shape of the scoop.

9. Thank the learners for making the scoop.

10. Ask another learner to fill the milk tin using the scoop.

11. Ask the learners to count how many scoops are needed to fill the milk tin.

12. When the container is full, put the lid on tightly

13. Say:

- Now you have a stool to sit on in the classroom.
- Remember, the container stool will not be as strong as a wooden stool and may not last as long.
- Remember the container stool is small so it is best for smaller children.

14. Show the learners the filled milk tin, an empty milk tin and a large jerry can.

15. Ask:

- Which container is heavy?

- Which container is light?

16. Ask some learners to pick up the different containers.

17. Ask:

- Which container is heavy?
- Is it easy to move?

18. Say:

- When we make a stool by filling a container with sand or soil we need to plan where we will do this.
- If we fill the container far from the classroom, it will be difficult to carry. It will be heavy. If we drop the container it will get damaged.
- We need to fill the container in the classroom. This means we must bring sand or soil to the classroom.
- To keep the classroom clean we must cover the floor to collect soil or sand that is spilled.

19. Say:

- It is important to keep the floor clean.
- Remember: Sweep the space clean to avoid slipping.

20. Read out the key message:

**Plan your work before you start.**

21. Repeat with learners.

22. Say the key message to the music beat.

23. Repeat with learners.

**Materials for activity 6:**

Large jerry can

Container of soil or sand

Paper or plastic to cover the floor

Toolkit

Plastic bottles

## Activity 6: Demonstration: Jerry Can

1. Say:

- I am going to show you how to make a stool from a jerry can.
- Look carefully at what I do.

2. Take the jerry can. Check it has no holes in it.

3. Say:

- I need to plan where I will fill my jerry can with soil.

4. Ask:

- Where will I use the stool?
- Will the jerry can stool be easy to move when I have filled it?
- Where shall I fill the jerry can?
- How will I bring the soil to the jerry can?

5. Say:

**Teaching tip for activity 6:**

Learners may need to make a scoop, and pots.

- I will fill the jerry can in the classroom.
  - I will bring soil in other containers to use in the classroom.
6. Ask the learners to take the pot they made outside and fill it with soil.
  7. Put all the pots near the jerry can.
  8. Ask a learner to fill the jerry can with soil using a scoop.
  9. Ask the learners to count how many scoops are needed to fill the jerry can.
  10. After a few scoops ask:
    - Is it easy to put soil through the small hole at the top?
    - What can we use to help us put the soil into the jerry can?
  11. Say:
    - We can use a funnel to put the sand or soil into the container.
  12. Ask a learner to come to the front to make a funnel from a plastic bottle.
  13. Thank the learner for making the funnel.
  14. Ask 2 learners to fill the jerry can with soil. Count the number of scoops.
  15. Say:
    - It is important to put all the waste pieces we don't want in the rubbish bin.
    - Remember: Use a rubbish bin. A messy space is dangerous.
    - Remember: Sweep the space clean to avoid slipping.
  16. When the jerry can is full, thank the learners and sit on it.
  17. Read out the key message:

**Plan your work before you start.**
  18. Repeat with learners.
  19. Say the key message to the music beat.
  20. Repeat with learners.

**Materials for activity 7:**

Tool kit  
Rubbish bin

## Activity 7: Making a Stool

1. Put the learners into 5 groups.
2. Ask learners to put the containers they brought on the floor.
3. Say:
  - If your group has a lot of container then you can make one stool each.

- If your group only has one or two containers, the group will work together to make one stool. Take it in turns to do each step.
4. Give a toolkit to each group.
  5. Say:
    - Each group can make their stools now.
    - When you have finished write your names on in marker pen.
    - Remember: Use a rubbish bin. A messy space is dangerous.
    - Remember: Sweep the space clean to avoid slipping.
  6. Monitor the groups and provide help when needed. Make comments to the group:
    - I like the way you are helping each other.
    - I like the way you are being careful not to spill soil.
  7. When everyone has finished collect the tools.
  8. Ask each group to show their items in turn.
  9. Ask:
    - How will you use these items?
  10. Ask the learners to sit on their stools.

## Activity 8: Key Message

1. Ask learners if they remember the key message.
2. Write the key message on the blackboard.
 

**Plan your work before you start.**
3. Read the message. Move your finger under each word as you read it.
4. Ask learners to say the message with you. Point to each word as you read it together.
5. Ask different learners to read the message.
6. Ask learners to come to the front and underline a word in the message such as: plan, work, start.
7. Ask learners to copy the message and draw a picture to go with it.

### Materials for activity 9:

Stones or sticks  
3 pots made from water bottles with a happy, normal and sad face

## Activity 9: Assessment

1. Put learners into groups of 2.
2. Ask each group of 2 learners to talk about the following questions:



- What 2 things did you learn today?
- What did you like doing the best?
- What will you tell and show your family about today?

3. Ask some groups to share their answers with the class.

4. Say:

- In the next session we will learn how to make a ball from recycled materials.
- We will need some paper, string and plastic bags.
- Each learner should try to bring these items to the next class.



5. Find three places on the floor or use 3 pots and mark them: happy face, normal face and sad face.

6. Ask each learner to put a stone or stick next to the place that shows how they felt about the session.

7. Write down how many learners put a stone next to each face in order to keep track of which lessons work well and which lessons could be improved.





# Session 4: Plastic Bag Ball

**Message:** Girls and boys can play ball games

## English Vocabulary:

- ball
- cuboid
- sphere
- cylinder
- point
- surface
- edge
- twist
- turn
- tie

## English Phrases:

This is a \_\_\_\_\_  
Find the \_\_\_\_\_

## Materials for activity 2:

Plastic bag ball

Cuboid shape –  
e.g. a carton,  
thick book,  
board eraser

Cylinder shape:  
stick, bottle,  
pencil, marker  
pen

## Activity 1: Introduction

1. Ask

- What did you learn in the last session?
- What did we make in the last session?
- What did we use to make it?
- What did you do with the things you made in the last session?
- Can you tell the class about it?

2. Say:

- Today we learn how to make a ball from materials we can find around us.
- We will learn some games that both boys and girls can play.
- We will also look shapes and what they can do.

3. Ask:

- Who has a ball?
- What is it made of?

## Activity 2: Maths

1. Hold up a plastic bag ball, then a box and a bottle or pencil.

2. Ask:

- What shape is this?

3. Say:

- The shape of a ball is called a sphere.
- The shape of a box is a cuboid.
- The shape of a stick/pencil/bottle is a cylinder.

### Using Local Language to Describe Words:

If learners have trouble using English to describe the picture, allow them to name what they see using their local language. Use these local language words to introduce the English words in this step.

6. Say:

- Let's learn the English words.

7. Point to each item in turn and say:

- This is a **sphere**.
- This is a **cuboid**.
- This is a **cylinder**.

8. Point to the item and ask:

- What is this?
- Learners should respond in English: This is a \_\_\_\_\_ .

9. Repeat with 5-10 learners.

10. Select a learner. Say:

- Find the **sphere**.
- Find the **cuboid**.
- Find the **cylinder**.

11. Repeat with 5-10 learners.

12. Hold up a cuboid. Show and say:

- This is a point.
- This is an edge.
- This is a surface.

13. Show a shape and ask:

- How many points?
- How many edges?
- How many surfaces?

14. Say:

- A cuboid has 8 points, 12 edges and 6 surfaces.
- A cylinder has no points, 2 edges and 3 surfaces.
- A sphere has a surface but no points or edges.

## Activity 3: **Beat the Words**

1. Say the first vocabulary word. Ask the learners to repeat it after you.

2. Say:

- Listen while I clap the syllables in this word.

### **Teaching Syllables:**

#### **Syllables in Vocabulary Words**

- **sphere:** 1 syllable = 1 clap

- **cu / boid:** 2 syllables = 2 claps
- **cy / lin / der:** 3 syllables = 3 claps
- **point:** 1 syllable = 1 claps
- **sur / face:** 2 syllables = 2 claps
- **edge:** 1 syllable = 1 clap
- **ball:** 1 syllable = 1 clap

3. Say the word again while clapping the syllables.
4. Repeat with learners.
5. Ask learners to identify the number of syllables in the word.
6. Use your fingers to count the number of syllables together with the class.
7. Repeat with the other vocabulary words.

**Materials for  
activity 4:**

Plastic bag ball  
Cuboid shape  
Cylinder shape  
Book

## Activity 4: Science

1. Make a steep slope using a book.
2. Say:
  - I am going to put the cuboid at the top of the slope. What will happen when I let it go?
3. Discuss what the learners think will happen.
4. Put the cuboid at the top of the slope and let go.
5. Repeat for the cylinder and sphere.
6. Repeat steps 2-5 for a medium slope and then a gently slope.
7. Say:
  - The cuboid does not move unless it is pushed.
  - The cylinder rolls down the slope on the curved surface. The cylinder does not move on the flat surface but falls.
  - The sphere rolls down the slope.
8. Ask:
  - If we want a good ball to play with which shape is best?
  - If we make a ball, which shape should we use?
9. Say:
  - When we make a ball we must try to make a good sphere shape.
  - We don't want any lumps or points on the ball.
  - Lumps and points mean it will not roll well.
10. Read out the key message:



### **Girls and boys can play ball games.**

11. Repeat with learners.
12. Say the key message to a music beat.
13. Repeat with learners.

#### **Materials for activity 5:**

Plastic bags  
String  
Old paper  
Toolkit  
Rubbish bin  
Learner bag  
Thick string to demonstrate weaving

## **Activity 5: Preparation**

1. Put the learners into a large circle.
2. Say:
  - We are going to prepare to make a plastic bag ball.
3. Show the materials needed to make a plastic bag ball.
  - Newspaper or old plastic sheeting
  - Plastic bags (3 or more)
  - String or twine
  - Rubbish bin
4. Point to each item in turn and ask:
  - What is this?
  - Learners should respond in English: This is a \_\_\_\_\_
5. Repeat with 5-10 learners.
6. Show a word card and read the word.
7. Ask a learner to put the word card by the item it describes.
8. Repeat for all the word cards.
9. Ask:
  - Is the space safe?
  - Is your body safe? Are you dressed correctly?
10. Remind the learners of the Skills for Life Plus rules.
11. Ask the learners to make their body and the space safe.
12. Read out the key message:  
**Girls and boys can play ball games.**
13. Repeat with learners.
14. Say the key message to the music beat.
15. Repeat with learners.

#### **Materials for activity 5:**

Make large word cards for each of the following words: plastic bag, string, newspaper, scissors, rubbish bin

## **Activity 6: Demonstration**

1. Say:
  - I am going to show you how to make a plastic bag ball.
  - Look carefully at what I do.
2. Say:

- Remember: Use a rubbish bin. A messy space is dangerous.

3. Follow the instructions from 1-16

4. Take a learners bag which is a plain colour.

5. Say:

- I will demonstrate how to weave the string. Watch me carefully.

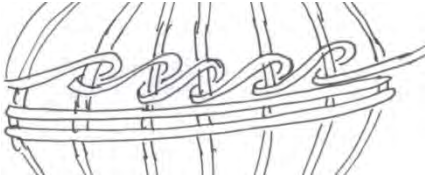

6. Wrap the string around the bag in lines.

7. Take the loose string and pass it over the string on the bag away from you. Then pass the loose string under the string on the bag towards you. Pull the string tightly as you move to the next string on the bag.

8. Repeat for all the ball strings.

9. Make another line of weaving.

10. Ask a learner to weave the string on the bag.

11. Repeat with a few more learners.

12. Say:

- The weaving needs practice.
- When we make our ball, we can practice weaving on this bag.

13. Follow instructions 17-19

14. When you have finished put all the waste pieces in the rubbish bin.

15. Pass the ball around the circle.



# Plastic bag ball

## Materials

Newspaper or old plastic  
3 or more plastic bags  
String

1. Put the materials in front of you: plastic bags, newspaper, string. Save a good plastic bag to use last.
2. Squeeze the newspaper tightly into a sphere shape. Make the newspaper sphere about the size you want the finished ball.
3. Put the paper in the first plastic bag. Shape the bag around the paper.
4. Twist the bag a few times.
5. Hold the small ball and cover it again with the plastic bag. Turn the bag over the ball the other way.
6. Twist the ball a few times. If you have a large bag you may be able to do the twist and turn process again.
7. Tie the bags sides together. Try not to make a lump in your ball.
8. Put the ball in more plastic bags. Twist the ball, turn the bag and tie it. Keep the ball a sphere. Make sure there are no lumps.
9. When you are happy with the size of the ball, put the last good bag on.
10. Use the string to tie the bag sides together tightly. Leave a finger length of string on one end. The other end is used to wrap around the ball.
11. Wrap this string around the ball a few times.
12. Wrap the string around the ball to divide it into segments.
13. Now turn the ball a quarter turn (90 degrees). Put your finger on the string and wrap it around the ball a few times.
14. Now you are ready to weave between the strings to make the ball strong.
15. Take the string in your hand – pass over the ball string then pass it under the same string. Pull tightly then move to the next ball string. Do this as much as possible to keep the ball strong and in shape.
16. When the weaving is finished tie the last piece of string to the first piece and cut it.
17. The more time and care you spend to make your ball, the longer it will last.



# Plastic bag ball

## Materials

Newspaper or old plastic  
3 or more plastic bags  
String  
Scissors

1. Put the materials in front of you: plastic bags, newspaper, string. Save a good plastic bag to use last.



2. Squeeze the newspaper tightly into a sphere shape. Make the newspaper sphere about the size you want the finished ball.



3. Put the paper in the first plastic bag. Shape the bag around the paper.



4. Twist the bag a few times.



5. Hold the small ball and cover it again with the plastic bag. Turn the bag over the ball the other way.
- 6.



7. Twist the bag a few times. If you have a large bag you may be able to do the twist and turn process again.
8. Tie the bags sides together. Try not to make a lump in your ball.



9. Put the ball in more plastic bags. Twist the ball, turn the bag and tie it. Keep the ball a sphere. Make sure there are no lumps.
10. When you are happy with the size of the ball, put the last good bag on.

11. Use the string to tie the bag sides together tightly. Leave a finger length of string on the end.

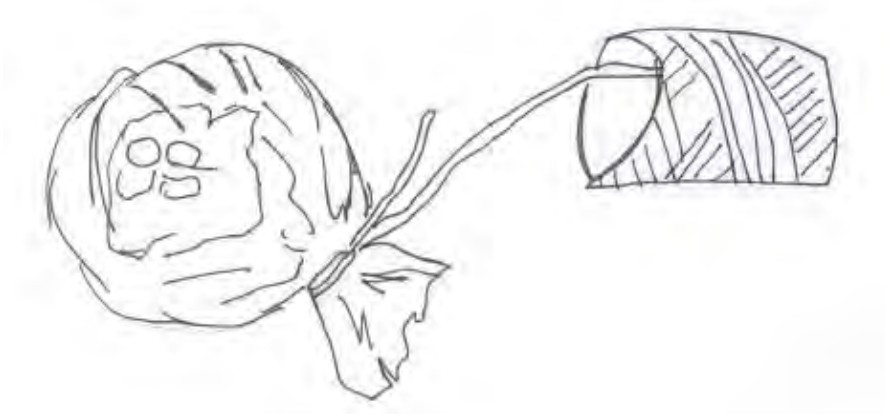

12. Wrap this string around the ball a few times.

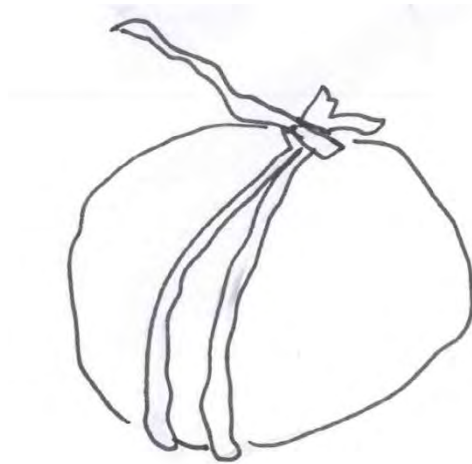

13. Wrap the string around the ball to divide it into segments.

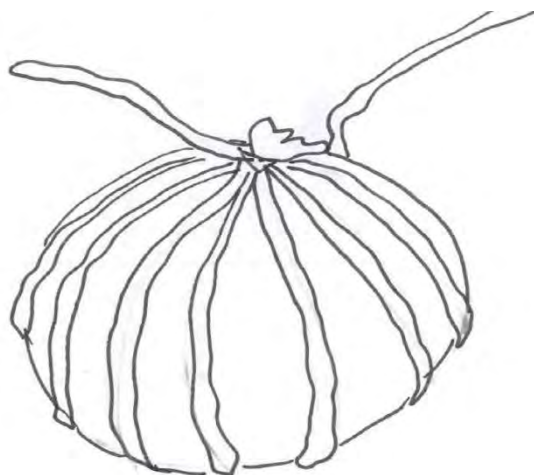

14. Now turn the ball a quarter turn (90 degrees). Put your finger on the string and wrap it around the ball a few times.

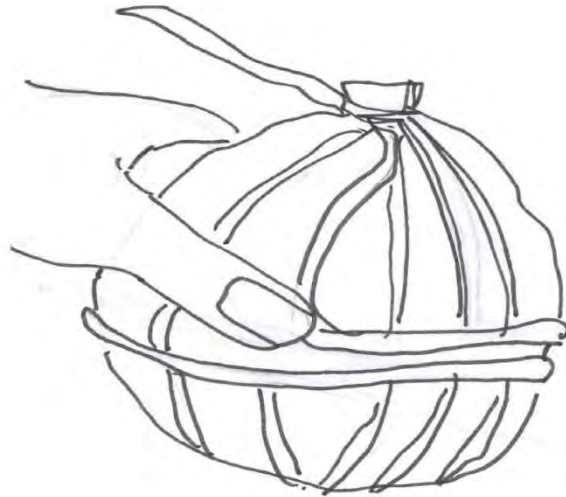

15. Now you are ready to weave between the strings to make the ball strong.

16. Take the string in your hand – pass over the ball string then pass it under the same string. Pull tightly then move to the next ball string. Do this as much as possible to keep the ball strong and in shape.

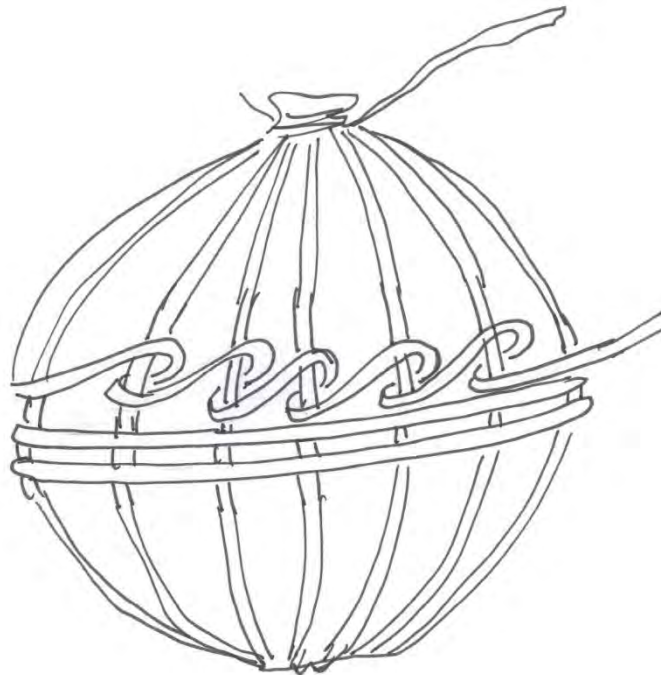

17. When the weaving is finished tie the last piece of string to the first piece and cut it.

18. The more time and care you spend to make your ball, the longer it will last.

**Materials for  
activity 7:**

Tool kit

Rubbish bin

## Activity 7: Making a Plastic Bag Ball

1. Put the learners into 5 groups.
2. Ask the learners to hold up the materials they brought to make the plastic bag ball
3. Say:
  - If your group has lots of bags and paper, then you can try to make one ball each.
  - If you group only has a few bags, everyone in the group will work together to make one ball.
  - Decide who will
    - start the ball
    - add the bags, twist and turn
    - wrap the string around
    - weave the string
4. Give a toolkit to each group.
5. Say:
  - Each group can make their ball.
  - Remember that if you think the shape is not a sphere, start again.
  - I will bring string around to learners that need it.
6. Monitor the groups and provide help when needed. Make comments to the group:
  - I like the way you are helping each other.
  - I like the way that you are making a good shape.
  - I like the way you are weaving the string.
  - I like the way you are being careful with the scissors.
7. When everyone has finished collect the tools.
8. Ask each group to show their ball in turn.
9. Ask:
  - How do you feel now that you have made a ball?

## Activity 8: Games with a Ball

1. Ask the learners:
  - What games we can play with a ball?
  - Who plays these games? Boys or girls?
2. Say:
  - The following games can be played by both girls and boys.
3. Take the learners to a large space.

4. Give the instructions and play each of the following games:

- Pass the ball along the line
- Knee relay
- Throwing the ball into a bucket/pot/carton
- Throwing the ball through a hoop (netball, basketball)
- Water bottle filling game

5. Let the learners go outside and play with their ball.

## **Pass the ball along the line**

- Put the learners into 4 teams.
- Each team makes a line. One behind the other.
- The learner at the front has the ball.
- When the game starts the first person must pass the ball over their head to the next person in line and so on until the last person gets the ball.
- The last person runs to the front and passes the ball over their head to the next in line.
- Continue until everyone has been to the front.
- The winners are the team who finish first.

This game can also be played by passing the ball along the line:

- Between legs
- Over one learner's head then between the next learners legs then over the head and between the legs.

## **Knee relay**

- Divide the learners into 4 teams.
- Draw 2 lines on the ground about 10 metres apart.
- Divide the teams into two halves. One half is behind one line, the other half is behind the other line.
- There is one ball per team. The first person puts the ball between their knees and carries it to the team member opposite. They give it to the next team member then sit down. The next team member carries it between their legs to the next team member on the opposite side.
- The winner is the first team which has everyone sitting down.

## Throwing the ball for points

- Draw a line on the ground.
- Put a series of containers on the ground a distance of between 2 to 5 metres from the line. Or make a series of shallow holes in the ground a distance of 2 – 5 metres from the line.
- The game is more interesting if each container is given points. The closest container has the lowest points and the container furthest away the most points.
- Each person has 5 throws of the ball.
- When the ball goes in the container or hole, the learner keeps the points.
- The winner is the learner who has the most points after 5 throws.

## Throwing the ball through a hoop

- Netball and basketball are games of skill. One skill is to throw a ball through the hoop.
- Make a hoop from wire, creeper or use a carton.
- Tie the hoop/carton onto a wall or tree.
- Practice throwing the ball into the top of the hoop.

## Water bottle filling game

- You need about 5 players.
- Place the empty water bottle in the middle.
- Mark out a circle on the ground about 3-4 metres from the water bottle.
- One player inside the circle has to fill the water bottle with sand.
- The other players stand outside the circle with the plastic bag ball. They throw the ball to try and hit the water bottle filler.
- If the water bottle filler is hit with the ball, the water bottle must be emptied.
- The aim of the game is for the water filler to dodge the ball and completely fill the water bottle.
- When the water bottle is full, another player can take a turn to be the water bottle filler.

## Mokou Stone building game

The game of Mokou (pronounced mo-koo) is played in Lesotho by groups of children during their free time.

How to play:

You need two teams to play Mokou. About five in one team, the builders and the same number in the rival side, the throwers. You will also need a soft ball (made out of a few plastic bags and tied up) so that it does not hurt the players and a selection of fairly flat stones.

The aim of the game is for the building team to create the highest pile of stones without getting hit with the ball by the throwing team.

- Mark out a circle on the ground that builders are not allowed out of, and throwers are not allowed into, to make sure the throwers do not get too close to the builders.
- The stones are placed in the centre of the playing space.
- The building team surrounds the stones and can shield those in their team placing the stones on top of each other.
- The throwing team throws the ball at the builders, trying to get them out and stop them building up the stones. They can pass the ball around to help them outwit the other team.
- The building team has to dodge the ball by jumping out of the way.
- As soon as a member of the building team is hit by the ball, they need to leave the game, exposing the builders making a pile of balancing stones.
- If the pile of stones falls over, it needs to be started again.
- The building team has to try and put as many stones as possible on top of each other before all of their team is out.
- When all of the building team is out the number of stones in the pile is counted and the teams swap over.



## Activity 9: Key Message

1. Ask learners if they remember the key message.
2. Write the key message on the blackboard.  
**Girls and boys can play ball games.**
3. Read the message. Move your finger under each word as you read it.
4. Ask learners to say the message with you. Point to each word as you read it together.
5. Ask different learners to read the message.
6. Ask learners to come to the front and underline a word in the message such as: ball, play, girl, boy.
7. Ask learners to copy the message and draw a picture to go with it.

### Materials for activity 10:

Stones or sticks  
3 pots made from water bottles with a happy, normal and sad face



## Activity 10: Assessment

1. Put learners into groups of 2.
2. Ask each group of 2 learners to talk about the following questions:
  - What 2 things did you learn today?
  - What did you like doing the best?
  - What will you tell and show your family about today?
3. Ask some groups to share their answers with the class.
4. Say:
  - In the next session we will learn how to make a light from recycled materials.
  - We will need plastic bottles, a stick and some thick string.
  - Each learner should try to bring these items to the next class.
5. Find three places on the floor or use 3 pots and mark them: happy face, normal face and sad face.
6. Ask each learner to put a stone or stick next to the place that shows how they felt about the session.
7. Write down how many learners put a stone next to each face in order to keep track of which lessons work well and which lessons could be improved.

# Session 5: Jump Rope

**Message:** Girls and boys can play jump rope.

## Important words:

**Stress:** pressure on your mind or body that makes you feel bad

**Emergency:** an unexpected and dangerous situation

## English Vocabulary:

- jump rope
- knot

## English Phrases:

Can you pass the scissors please?  
Thank you.

How emergencies affect us



## Activity 1: Introduction

1. Ask

- What did you learn in the last session?
- What did we make in the last session?
- What did we use to make it?
- What did you do with the things you made in the last session?
- Can you tell the class about it?

2. Say:

- Today we learn how to make a jump rope from materials we can find around us.
- We will learn some games that both boys and girls can play.
- We will also learn to estimate amounts.

3. Ask:

- Who has a jump rope?
- What is it made of?

## Activity 2: Picture Discussion

1. Hold up the Module 1, Session 4 picture.

2. Ask:

- What can you see in this picture?
- What are the children doing?
- How do the children on their own feel?

3. Say:

- These children are showing stressful feelings.

4. Point to the children in the picture and say:

- This is Anna. She is quiet and alone. She does not smile or play with friends. She does not feel hungry. She cannot think about her work.
- This is Ruben. He feels tired. He cannot sleep because he has bad dreams. He feels afraid. He is sad and sometimes he cries. He has pain in his head and

stomach. He misses his mother and he wants to go home.

- This is Abraham. He saw something scary happen to his family. Now he is afraid that something bad will happen again. He does not trust anyone. He is angry. He shouts, kicks and hits things.

5. Say:

- All of these stressful feelings are normal after an Emergency.
- It is normal to feel upset during sad or scary times.
- It is good to think of happy things and feel better.
- It is good to play sport or a game to help us feel better.

6. Ask learners to talk with their neighbour about what makes them feel better.

7. Ask some learners to tell the class.

8. Say: These things can help us feel better:

- Talk to your friends about your feelings
- Pray
- Read the Bible or Koran
- Play a with friends in safe areas
- Do a useful activity like sweep the compound
- Play a sport like football or jump rope or volleyball
- Sing or listen to music
- Take part in community events
- Take part in school clubs

9. Say:

- Sometimes when we feel stressed we want to be on our own.

10. Ask:

- What activities can we do on our own?

11. Say:

- Pray
- Read the Bible or Koran
- Do a useful activity like sweep the compound
- Play jump rope
- Sing or listen to music

12. Say:

- Skipping on our own using a jump rope helps us when we feel stressed.
- It makes us exercise and gives us a fun activity we can do on our own.

13. Read out the key message:

**Girls and boys can play jump rope.**

14. Repeat with learners.
15. Say the key message to a music beat.
16. Repeat with learners.

## Activity 3: Song

1. Sing: If You Are Happy and You Know It.
2. Sing the song 3 times. Do the body movements from the song.

### Verse 1

If you are happy and you know it clap your hands,  
If you are happy and you know it clap your hands,  
If you are happy and you know it and you really want to  
show it,  
If you are happy and you know it clap your hands.

### Verse 2

If you are happy and you know it click your fingers,  
If you are happy and you know it click your fingers,  
If you are happy and you know it and you really want to  
show it,  
If you are happy and you know it click your fingers.

### Verse 3

If you are happy and you know it stamp your feet,  
If you are happy and you know it stamp your feet,  
If you are happy and you know it and you really want to  
show it,  
If you are happy and you know it stamp your feet.

### Materials for activity 4:

Inner tube  
Scissors  
Rubbish bin

## Activity 4: Preparation

1. Put the learners into a large circle.
2. Say:
  - We are going to prepare to make a jump rope.
3. Show the materials needed to make a jump rope.
  - Inner tube from a wheel
  - Scissors
  - Rubbish bin

**Materials for activity 4:**

Make large word cards for each of the following words: inner tube, scissors, rubbish bin

4. Point to each item in turn and ask:
  - What is this?
  - Learners should respond in English: This is a \_\_\_\_\_
5. Repeat with 5-10 learners.
6. Show a word card and read the word.
7. Ask a learner to put the word card by the item it describes.
8. Repeat for all the word cards.
10. Ask:
  - Is the space safe?
  - Is your body safe? Are you dressed correctly?
11. Remind the learners of the Skills for Life Plus rules.
12. Ask the learners to make their body and the space safe.
13. Read out the key message:

**Girls and boys can play jump rope.**
14. Repeat with learners.
15. Say the key message to the music beat.
16. Repeat with learners.

**Materials for activity 5:**

Inner tube  
Scissors  
Rubbish bin

## Activity 5: Estimation

1. Show the learners the inner tube.
2. Say:
  - We will cut the inner tube to make circles of rubber.
  - We will cut from the middle to the outside.
  - We will knot the circles of rubber together to make the jump rope.
3. Ask:
  - How many circles of rubber will we need to cut?
4. Say:
  - We need to make the jump rope the correct size to skip well.
5. Ask a learner to come to the front and hold their hands as if they are skipping.
6. Say:
  - A jump rope must be long enough to go from the right hand, touch the ground then reach the left hand.
  - Use your hand to measure the width of the inner tube. (Palm width or hand length)
  - Now use your hand to measure from the learner's right hand down to the ground and up to the left hand.

- Count as you measure.
7. Say.
    - I need **X** palm width/hand lengths to make a jump rope which means I need to cut **X** circles of inner tube.
  8. Put the learners in groups of 2.
  9. Ask learners to take turns. One learner pretends to hold a jump rope and the other measures from one hand to the ground and back to the other hand.
  10. Ask learners to change over.
  11. Ask each learner to tell you how many circles of inner tube they estimate they need to make a jump rope.
  13. Read out the key message:
 

**Girls and boys can play jump rope.**
  14. Repeat with learners.
  15. Say the key message to the music beat.
  16. Repeat with learners.

## Activity 6: **Passing Scissors**

1. Say:
  - We cut a lot of circles from the inner tube to make the jump rope.
  - As it is a little hard, we will take it in turns.
  - We need to learn to ask for the scissors.
2. Ask 5 learners to come to the front and hold a pair of scissors.
3. Ask one learner:
  - Can I have the scissors please?
4. The learner replies “yes” and passes the scissors safely holding the blade.
5. Reply using “thank you”.
6. Repeat with the other learners.
7. Say:
  - Can I have the scissors please?
8. Ask the learners to repeat after you.
9. Do this 3 times.
10. Ask the first learner at the front to ask for the scissors using “Can I have the scissors please?”
11. The second learner asks the first learner.

12. Repeat until all learners at the front have practised the question.
13. Put the learners in groups of 2.
14. Practice the question: Can I have the scissors please?

**Materials for  
activity 7:**

Toolkit

Inner tube

Rubbish bin

## Activity 7: **Demonstration**

1. Say:

- I am going to show you how to make a jump rope.
- Look carefully at what I do.

2. Say:

- Remember: Use a rubbish bin. A messy space is dangerous.

3. Follow the instructions to cut the inner tube circles.

- Cut the inner tube in a straight line from the middle to the outside, close to the valve.
- Use your finger to measure one finger width. Mark it with marker pen.
- Cut a strip of inner tube that is one finger width wide.
- Check it is a circle.

4. Repeat step 2 until you have got the number of circles you estimated.

5. Say:

- I will demonstrate how to knot 2 circles of inner tube together. Watch me carefully.
- Hold one piece of inner tube vertical.
- Thread 1/3 of second piece of inner tube through the top of the vertical circle.
- Open the 1/3 of the second piece and thread the rest of the second piece of inner tube through it and pull tightly.
- Repeat with a third piece of inner tube.

6 Ask a learner to add a circle of inner tube.

7. Repeat with a few more learners.

8. Say:

- The knotting takes practice.
- If we do not make a good knot the first time, we can start again.

9. When you have finished put all the waste pieces in the rubbish bin.

10. Ask a learner to skip with the jump rope.

11. Read out the key message:

**Girls and boys can play jump rope.**

12. Repeat with learners.

13. Say the key message to the music beat.

14. Repeat with learners.



# Jump Rope

## Materials

Toolkit

Inner tube

Rubbish bin

1. Cut the inner tube in a straight line from the middle to the outside, close to the valve.
2. Use your finger to measure one finger width. Mark it with marker pen.
3. Cut a strip of inner tube that is one finger width wide. Check it is a circle.

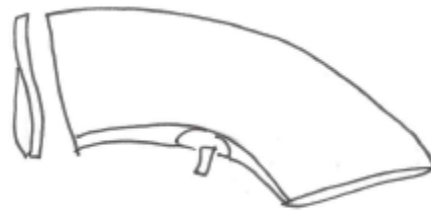

4. Repeat step 2 until you have got the number of circles you estimated.
5. Knot 2 circles of inner tube together - Hold one piece of inner tube vertical.
6. Thread 1/3 of second piece of inner tube through the top of the vertical circle.
7. Open the 1/3 of the second piece and thread the rest of the second piece of inner tube through it and pull tightly.

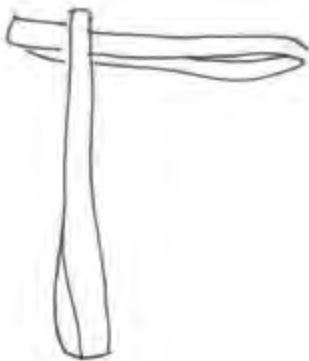



8. Repeat with a third piece of inner tube.
9. Repeat step 2 until you have a jump rope the correct length.
10. The knotting takes practice. If we do not make a good knot the first time, we can start again.
11. When you have finished put all the waste pieces in the rubbish bin.



**Materials for  
activity 8:**

Toolkit

Inner tube

Rubbish bin

## Activity 8: Making a Jump Rope

1. Put the learners into 5 groups.
2. Ask the learners to hold up the materials they brought to make the jump rope.
3. Say:
  - If your group has a good inner tube, then you can try to make one jump rope each.
  - If you group has a ripped inner tube then everyone will work together to make one jump rope.
  - Each person in the group will cut a circle of inner tube in turn and knot it to the jump rope.
4. Say:
  - We need to take it in turns to use the scissors.
  - Remember to ask “Can I have the scissors please?”
  - Remember to pass the scissors safely holding the blades together.
5. Give a toolkit to each group.
6. Say:
  - Each group can make their jump rope.
  - Remember if the knot is not good, try again.
7. Monitor the groups and provide help when needed. Make comments to the group:
  - I like the way you are helping each other.
  - I like the way you are asking for the scissors in English.
  - I like the way you knotting the circles of inner tube.
  - I like the way you are being careful with the scissors.
8. When everyone has finished collect the tools.
9. Ask each group to show their jump rope in turn.
10. Ask:
  - How do you feel now that you have made a jump rope?

## Activity 9: Using a Jump Rope

1. Take the learners outside.
2. Say:
  - Both girls and boys can skip with a jump rope.
  - Boxers use a jump rope to build up their strength.
3. Groups that made one jump rope must practice in turn.
4. Ask learners to skip with the jump rope.

5. After 1 minute change learners.
6. Continue until everyone has had a turn.
7. Ask the learners if they know any special ways to skip.
8. Ask the learner to demonstrate the special skip.
9. Show the learners how to do a double skip. This means turning the jump rope 2 times during the jump.
10. Show the learners how to jump using crossed arms.
11. Show the learners how to skip backwards.
12. Let the learners play with their jump rope.

## Activity 10: Key Message

1. Ask learners if they remember the key message.
2. Write the key message on the blackboard.  
**Girls and boys can play jump rope.**
3. Read the message. Move your finger under each word as you read it.
4. Ask learners to say the message with you. Point to each word as you read it together.
5. Ask different learners to read the message.
6. Ask learners to come to the front and underline a word in the message such as: play, rope, boys, girls, jump.
7. Ask learners to copy the message and draw a picture to go with it.

### Materials for activity 11:

Stones or sticks  
3 pots made from water bottles with a happy, normal and sad face

## Activity 11: Assessment

1. Put learners into groups of 2.
2. Ask each group of 2 learners to talk about the following questions:
  - What 2 things did you learn today?
  - What did you like doing the best?
  - What will you tell and show your family about today?
3. Ask some groups to share their answers with the class.
4. Say:
  - In the next session we will learn how to make a light from recycled materials.
  - We will need plastic bottles, a stick and some thick string.



- Each learner should try to bring these items to the next class.
5. Find three places on the floor or use 3 pots and mark them: happy face, normal face and sad face.
  6. Ask each learner to put a stone or stick next to the place that shows how they felt about the session.
  7. Write down how many learners put a stone next to each face in order to keep track of which lessons work well and which lessons could be improved.

# Session 6: Water Bottle Light

**Message:** Keep bleach out of reach of children.

## Important words:

**Refraction:** the bending of light caused by a change in its speed

## English Vocabulary:

- light
- dark
- clean
- glass
- plastic
- clear
- green
- brown

## English Phrases:

This is a \_\_\_\_\_  
Find the \_\_\_\_\_

## Materials for activity 2:

A4 paper  
pencil  
pots

## Activity 1: Introduction

1. Ask
  - What did you learn in the last session?
  - What did we make in the last session?
  - What did we use to make it?
  - What did you do with the things you made in the last session?
  - Can you tell the class about it?
2. Say:
  - Today we will learn how to make a light from a plastic water bottle. It can light up dark places during the day.
  - We will learn about the science of light.
  - We will look at shapes.
3. Ask:
  - Where does light come from?
  - Name some things that give light?

## Activity 2: Science of Light

1. Make a pot from a water bottle.
2. Fill the pot half full with water.
3. Show the learners the pot half full of water and in then a pencil.
4. Draw the pot on the black board or a piece of A4 paper.
5. Ask the learners to draw what the pencil will look like when it is placed in the pot of water.
6. Ask some learners to come to the front and draw the pencil in the pot of water on the blackboard/A4 paper.
7. Hold up the pot of water and put the pencil in.
8. Say:
  - We will pass the pot around the class. Look carefully at the pencil through the side of the pot. Don't tell what you see.
9. Pass the pot with the pencil around the circle.
10. Ask:

- What does the pencil look like in the water?

11. Ask some learners to come to the front and draw the pencil in the pot of water on the blackboard/A4 paper.

12. Check the drawings are correct.

13. Say:

- Light can produce some strange effects.
- When the pencil is placed in the pot of water and we look at it through the side, the pencil looks bent or broken.
- The reason the pencil looks bent is that light travels slower through water than air.
- When the light enters the pot of water, and when it leaves the pot, it changes speed and direction, making the pencil look bent.
- We call this refraction.



14. Say:

- We will use this property of light to make a water bottle light that uses the sun light.
- When light travels through water in a bottle it bends. This will make the light spread in different directions.

### Materials for activity 3:

Plastic bottles  
Bleach  
String / rope  
Stick  
Scissors  
Inner tube  
Rubbish bin  
2 pots  
Water

## Activity 3: Preparation

1. Put the learners into a large circle.

2. Say:

- We are going to prepare to make a water bottle light.

3. Show the items needed to make a water bottle light.

- Large clear plastic bottles
- Clean water - distilled or bottled water if possible. If not, filtered with cloth (see Healthy water session)
- Bleach
- Rope or string
- Stick
- Scissors
- Inner tube
- Rubbish bin

5. Say:

- Let's learn the English words.

6. Point to each item in turn and say:

- This is a **bottle**.
- This is a **stick**.
- This is a **rubbish bin**.

- This is **string**.
- This is **water**.
- This is **bleach**.
- This is **inner tube**.
- These are **scissors**.

7. Point to the item and ask:

- What is this?
- Learners should respond in English: This is a \_\_\_\_\_ .

8. Repeat with 5-10 learners.

9. Select a learner. Say:

- Find the **bottle**.
- Find the **stick**.
- Find the **rubbish bin**.
- Find the **string**.
- Find the **water**.
- Find the **bleach**.
- Find the **inner tube**.
- Find the **scissors**.

10. Repeat with 5-10 learners.

11. Show a word card and read the word.

12. Ask a learner to put the word card by the item it describes.

13. Repeat with different learners.

14. Repeat for all the word cards.

15. Ask:

- Is the space safe?
- Is your body safe? Are you dressed correctly?

16. Remind the learners of the Skills for Life Plus rules.

17. Ask the learners to make their body and the space safe.

### Materials for activity 3:

Make large word cards for each of the following words: string, bottle, stick, water, bleach, scissors, inner tube, rubbish bin

## Activity 4: Beat the Words

1. Say the first vocabulary word. Ask the learners to repeat it after you.

2. Say:

- Listen while I clap the syllables in this word.



## Teaching Syllables:

### Syllables in Vocabulary Words

- **stick:** 1 syllable = 1 clap
- **bot / fle:** 2 syllables = 2 claps
- **wa / ter:** 2 syllables = 2 claps
- **bleach:** 1 syllable = 1 clap
- **scis / sors:** 2 syllables = 2 claps
- **string:** 1 syllable = 1 clap
- **rub / bish / bin:** 3 syllables = 3 claps
- **in / ner / tube** 3 syllables = 3 claps

3. Say the word again while clapping the syllables.
4. Repeat with learners.
5. Ask learners to identify the number of syllables in the word.
6. Use your fingers to count the number of syllables together with the class.
7. Repeat with the other vocabulary words.

### Materials for activity 5:

Bleach  
2 pots  
Water



## Activity 5: Bleach Safety

1. Make 2 pots from water bottles.
2. Write on one pot **water** ✓ and half fill with water.
3. Write on the other pot **bleach X** and pour a finger width of bleach in.
4. Say:
  - Water is safe to drink.
5. Hold up the bottle of bleach. Show the sign that means it is dangerous.
6. Say:
  - The black cross on orange or yellow means harmful.
  - The hand on orange or yellow means it will burn.
7. Say:
  - Bleach is dangerous to drink and can kill you.
  - Bleach can burn your skin.
  - Bleach can damage your eyes and even cause blindness.
  - Bleach kills bacteria, virus and algae in water.
8. Hold up the 2 pots.

9. Say:

- Bleach and water look similar. They smell different.
- Ask a learner to come to the front to smell both pots.

10. Ask:

- What can you smell?

11. Say:

- I want everyone to recognise the smell of bleach.

12. Ask the class to line up.

13. Each learner in turn smells the pots of water and bleach.

14. Say:

- We use bleach mixed in a lot of water to make our clothes white.
- We use bleach mixed with water to clean our home.
- If we do not use it correctly it can be dangerous.

15. Ask:

- Do you have bleach at home?
- Where do you keep it?

16. Say:

- We must keep bleach in a safe place away from young children.
- Many young children are injured and die because they drink bleach. They think it is water.

17. Say:

- These are the safety rules when using bleach.
  - Take care. Do not spill bleach.
  - Put the top back on the bleach bottle after use.
  - After we use bleach we must wash our hands thoroughly.
  - Do not store bleach in soda bottles.
  - Destroy old bleach bottles.
  - Keep bleach out of reach of small children.

18. Ask:

- Where is a good place to keep a bleach bottle?

19. Say:

- Keep bleach on a shelf that small children cannot reach.
- Keep bleach in a locked cupboard or room.

20. Say:

- Sometimes accidents happen with bleach.

- A large bleach container is hard to handle. Spills and splashes happen. Bleach can damage your clothing, irritate your skin and cause serious damage to your eyes.
- This is what you do.
  - Bleach on your clothes: Take off your clothes and wash in water straight away.
  - Bleach on your skin: Wash straightaway with lots of running water.
  - Bleach in your eye: Wash with lots of water.
  - If swallowed: Drink a glass of water. Do not make the person vomit as the bleach will burn again. Take to the clinic or hospital immediately.

21. Read out the key message:

**Keep bleach out of reach of children.**

22. Repeat with learners

23. Say the key message to the music beat.

24. Repeat with learners.

## Activity 6: **Demonstration**

### **Materials for activity 6:**

Plastic bottles

Bleach

Scissors

Inner tube

Rubbish bin

Water

1. Say:

- I am going to show you how to make a water bottle light.
- Look carefully at what I do.

2. Say:

- Remember: Use a rubbish bin. A messy space is dangerous.

3. Follow the instructions to make a water bottle light.

4. When you have finished put all the waste pieces in the rubbish bin.

5. Ask:

- Is the water bottle light working?

6. Say:

- We will now test the water bottle light.

# Water bottle light

## Materials

Large water bottle  
Inner tube  
Marker pen  
Bottle of bleach  
Scissors

1. Make sure the water bottle and bottle top are clean.
2. Take the label off the bottle.
3. Cut a piece of inner tube. The length is twice the width.
4. Place the water bottle on the inner tube and use the marker or ball point to draw around the bottom.
5. Draw another smaller circle inside the first circle which is 1 finger width smaller.
6. Mark lines joining the small circle to the large circle.
7. Fold the inner tube in half so the circles are also in half.
8. Cut along the small circle line. This will make a hole in the inner tube.
9. Now make small cuts from the small circle to large circle.
10. Fit the inner tube hole over the top of the bottle and move it one quarter (1/4) down the bottle. Make sure the bottle fits tightly.
11. Remove the bottle from the inner tube and take the cap off.
12. Fill the large water bottle with filtered/mineral/distilled water  $\frac{3}{4}$  full.
13. Put the bottle on some paper on the ground and carefully add one capful of bleach to the bottle. Make sure you put the cap back on the bleach bottle.  
  
The bleach will stop the water from turning green with algae. Algae in the water will give less light and green light
14. Fill the water bottle right to the top and put the cap on tightly.
15. Fit the inner tube hole over the top of the bottle and move it one quarter (1/4) down the bottle. Make sure the bottle fits tightly.
16. Now your water bottle light is ready to install.

# Water bottle light

## Material

Large water bottle  
Inner tube  
Marker pen  
Bottle of bleach  
Scissors

1. Make sure the water bottle and bottle top are clean.
2. Take the label off the bottle.
3. Cut a piece of inner tube. The length is twice the width.

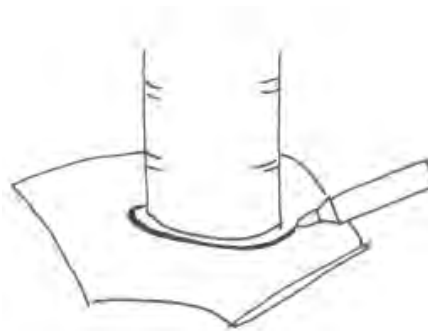

4. Place the water bottle on the inner tube and use the marker or ball point to draw around the bottom.

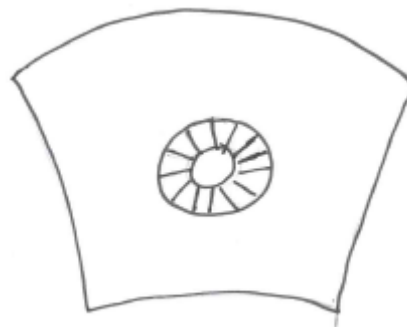
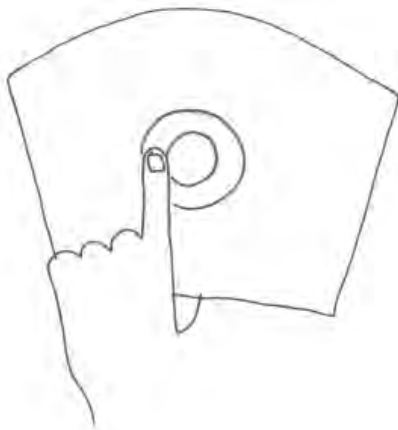

5. Draw another smaller circle inside the first circle which is 1 finger width smaller.
6. Mark lines joining the small circle to the large circle.

7. Fold the inner tube in half so the circles are also in half.

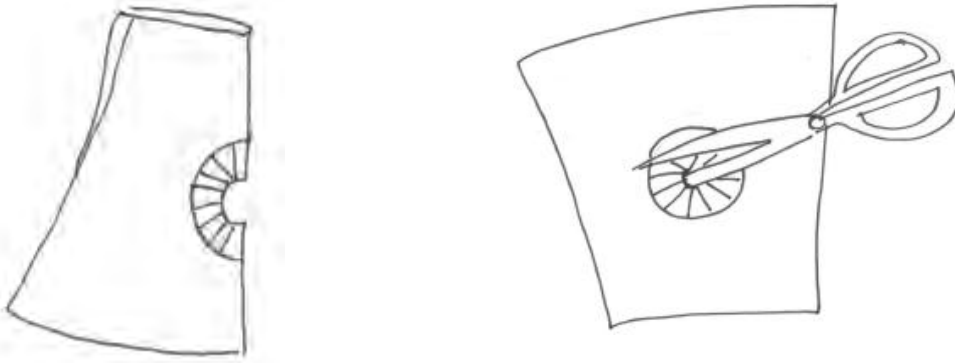

8. Cut along the small circle line. This will make a hole in the inner tube.

9. Now make small cuts from the small circle to large circle.

10. Fit the inner tube hole over the top of the bottle and move it one quarter (1/4) down the bottle. Make sure the bottle fits tightly.

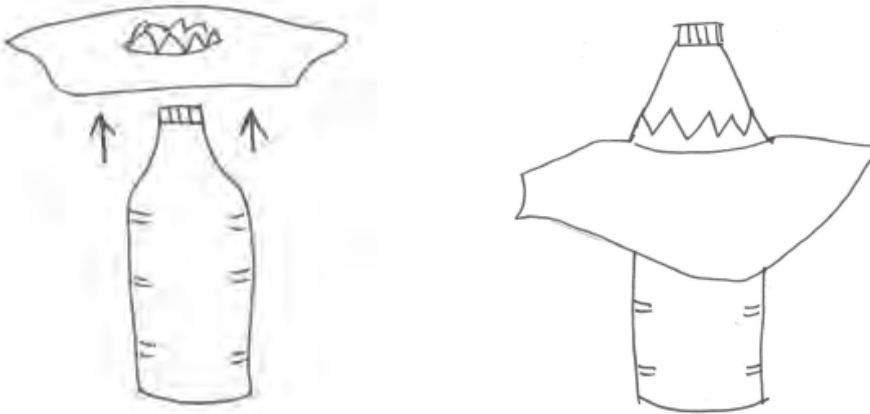

11. Remove the bottle from the inner tube and take the cap off.

12. Fill the large water bottle with filtered/mineral/distilled water  $\frac{3}{4}$  full.



13. Put the bottle on some paper on the ground and carefully add one capful of bleach to the bottle. Make sure you put the cap back on the bleach bottle.

The bleach will stop the water from turning green with algae. Algae in the water will give less light and green light

14. Fill the water bottle right to the top and put the cap on tightly.

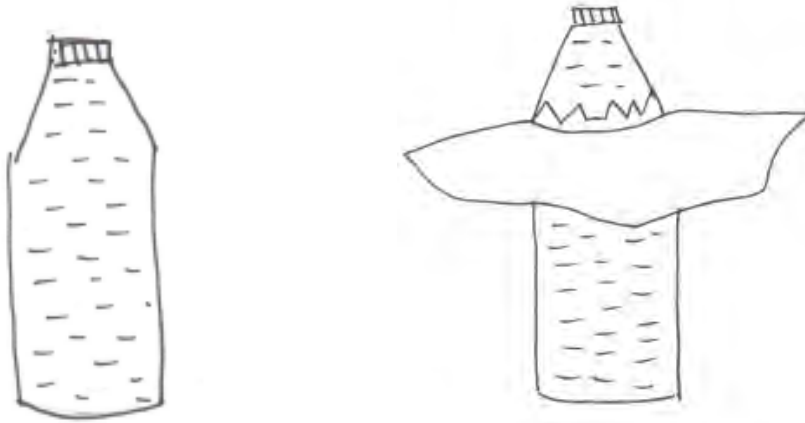

15. Fit the inner tube hole over the top of the bottle and move it one quarter (1/4) down the bottle. Make sure the bottle fits tightly.

16. Now your water bottle light is ready to install.



## Activity 7: Testing a Water Bottle Light

### Materials for activity 7:

2 tables  
Floor mats  
Tarpaulins  
Dark cloth  
Water bottle light  
Picture

1. Put the learners into a large circle.
2. Say:
  - We are going to test the water bottle light works.
  - We need to find or make a dark place.
3. Take the learners outside.
4. Make a tent which is dark inside. No light should enter. It should have a small space at the top to insert the water bottle light.

### How to make a dark tent

- Put 2 tables together with a space the width of a water bottle between them.
- Put the water bottle light in the space between the tables, near one end.
- Cover the tables with floor mats, tarpaulins, dark cloth or any other materials you have available. Make sure no light can enter.
- Do not cover the water bottle.
- Make a small opening in the tent at the other end to the water bottle light.

5. Carefully put a picture on the floor of the tent. Do not let learners see the picture.
6. Ask the learners to make a line.
7. Say:
  - Each learner in turn will look in the hole to see if the water bottle light is working.
  - Look carefully and remember what picture you see.
  - Do not tell anyone what you see in the tent.
8. When everyone has finished ask:
  - Could you see inside the tent using the water bottle light?
  - What picture did you see in the tent?
  - How easy was it to see in the tent?
  - Does the water bottle light work?
9. Take the learners inside.
10. Say:
  - The water bottle light works using the light of the sun and water.



- Sunlight is bent by the water in the bottle and spread around the room.
- It will not work at night because it needs sunlight.
- It can light up dark areas in your home during daytime such as your kitchen hut.
- A water bottle light can provide the same amount of light during the day as a 40 or 50 watt light bulb.
- If we use a water bottle light in our home during the day instead of an electric light we can save money.

### Materials for activity 8:

Large clear plastic bottle

Glass soda bottles of different colours and sizes

Plastic soda bottles of different colours and sizes

Small jerry can

Bottle dirty or scratched on the outside

## Activity 8: Which Bottle is Best?

1. Put the learners into a large circle.
2. Put lots of different bottles in the middle.
  - Clean bottles
  - Dirty bottles
  - Coloured bottles
  - Small bottles
  - Glass bottles
  - Small jerry can
3. Point to the item and ask:
  - What is this?
  - What colour is it?  
What is it made of?
  - Where can I find it?
4. Repeat with each bottle
5. Say:
  - Let's learn the English words.
6. Point to each item in turn and say:
  - This is a **glass bottle**.
  - This is a **plastic bottle**.
  - This is a **clear bottle**.
  - This is a **clean bottle**.
  - This is a **green bottle**.
  - This is a **brown bottle**
  - This is a **clean bottle**.
7. Point to the item and ask:
  - What is this?
  - Learners should respond in English: This is a \_\_\_\_\_ .
8. Repeat with 5-10 learners.
9. Select a learner. Say:
  - Find a **glass bottle**.

- Find a **plastic bottle**.
- Find a **clear bottle**.
- Find a **green bottle**.
- Find a **brown bottle**.
- Find a **clean bottle**.

10. Repeat with 5-10 learners.

11. Ask:

- Which bottle can make a good water bottle light?

12. Say:

- The best bottle for a water bottle light is:
  - Large 1.5 or 2 litres
  - Clear
  - Clean outside with no scratches
  - Not heavy
- So the best bottle for a water bottle light is a large water bottle.
- To make a better light we can tie 3 large water bottles together.

13. Ask:

- What could you do in a dark hut or dark tent using a water bottle light?

14. Read out the key message:

**Keep bleach out of reach of children.**

15. Repeat with learners.

16. Say the key message to a music beat.

17. Repeat with learners

**Materials for activity 9:**

Water bottle light

Stick

Strong string or rope

Ladder

## Activity 9: Installing a Water Bottle Light

1. Find a place that has thatch to demonstrate how to install the water bottle light.

2. Say:

- I am going to show how to install a water bottle light.
- Look carefully at what I do.

3. Follow the instructions.

4. Ask:

- Is the water bottle light working?
- Will you make a water bottle light for you home?

# Installing a water bottle light in thatch

## Materials

Ladder  
Stick  
Strong string or rope  
Water bottle light

1. Tie a length of rope around the bottle above the inner tube.
2. Leave a length of rope to tie the water bottle light to the roof.

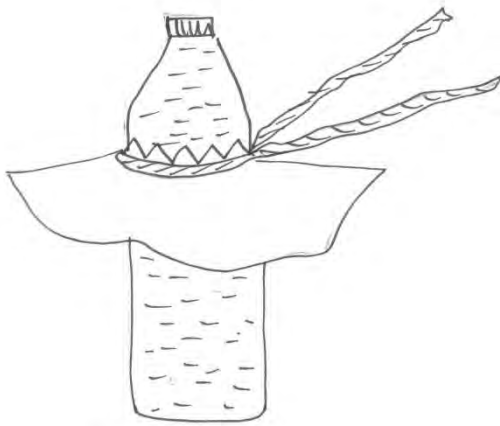

3. Ask adult to use a ladder to climb up the thatch roof of a hut. When you use a ladder make sure someone else is holding the bottom so the ladder does not slip.
4. Find the roof struts. Make a hole in the thatch between two roof struts.

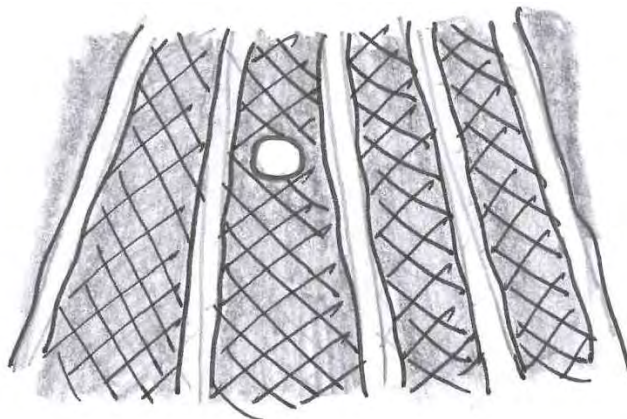

- Place the bottle in the hole.  
Make sure that about 1/4 the bottle is above the thatch and in the sun.  
The rest of the bottle is below the thatch.

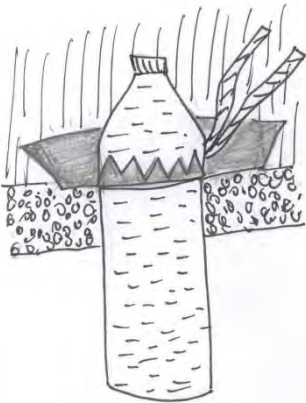

- The bottom half of the bottle will refract light into the hut.

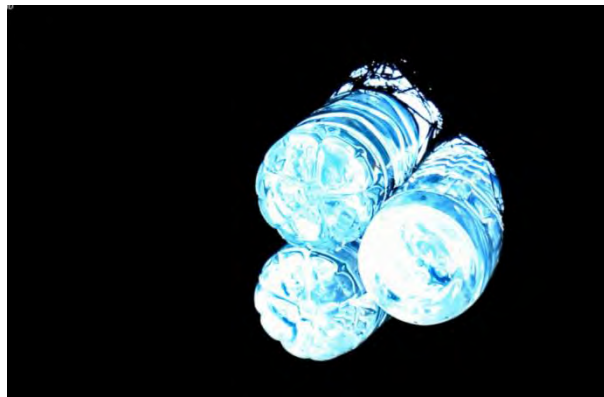

- Add a stick above the bottle to help keep it in place.
- Tie the bottle to the stick very well.

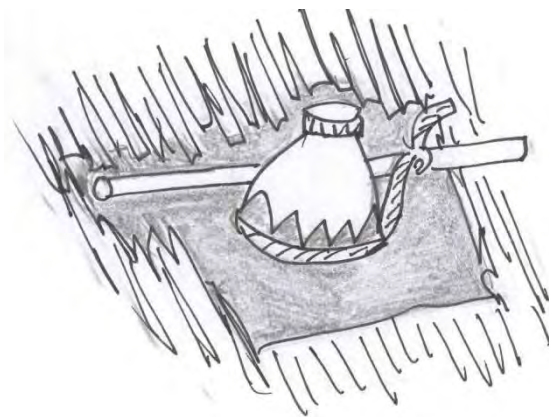

- Make sure the thatch fits tightly around the inner tube to prevent leaks when it rains.

**Remember: We need to keep the outside of the bottle clean or it will block the light.**

# Installing a water bottle light in a corrugated roof

We can also fit water bottle lights into corrugated roofs.

## Materials

Ladder

Stick

Strong string or rope

Water bottle light

1. Tie a length of rope around the bottle above the inner tube.
2. Leave a length of rope to tie the water bottle light to the roof.
3. Make a hole in the roof that is the same size as the bottle.
4. Gently push the bottle into the hole from the top.
5. Make sure that about 1/4 the bottle is above the roof and in the sun. The rest of the bottle is below the roof. The bottom half of the bottle will refract light into the hut.
6. Add a stick above the bottle to help keep it in place.
7. Tie the bottle to the stick very well.
8. The bottle needs to be fixed in place with polyester resin or rubber sealant from below so that the roof does not leak.



**Materials for activity 10:**

Toolkit

Bleach

Bottles

Inner tube

Rubbish bin

## Activity 10: Making a Water Bottle Light

1. Put the learners into 5 groups.
2. Ask the learners to hold up the materials they brought to make the water bottle light
3. Say:
  - If your group has lots of bottles and inner tube then you can try to make one light each.
  - If you group only has a few bottles or inner tube, everyone in the group will work together to make one light.
  - Decide who will:
    - Draw the circles on the inner tube
    - Cut the inner tube
    - Fill the bottle with water and add bleach
    - Put the bottle in the inner tube
4. Give a toolkit to each group.
5. Say:
  - Each group can make their light.
  - Remember to be careful with the scissors.
  - Come to me when you need the bleach.
6. Monitor the groups and provide help when needed. Make comments to the group:
  - I like the way you are helping each other.
  - I like the way that you being careful with the bleach.
  - I like the way you are being careful with the scissors.
7. When everyone has finished collect the tools.
8. Ask each group to show their lights in turn.
9. If the tent is still erected, ask each group to test their water bottle light in the tent.
- 10 Ask:
  - How do you feel now that you have made a light?
  - What will you do with the light?

## Activity 11: Story

1. Use the chart **Father saves money**
2. Show the first picture.
3. Ask:
  - What do you see in this picture?
  - What do you think is happening?



- What do you think will happen next?

4. Show the next picture.

5. Ask the questions again.

6. Now read the story while showing picture 1.



Okello is a shopkeeper. He has a small shop selling everyday items. The shop is in the market and it is very dark. To encourage his customers to buy more things Okello uses an electric light bulb to light up the back of the shop.

7. Now read the story while showing picture 2.



Okello has to pay his friend 5 SSP at the end of each day to use power from his generator.

Okello has two children at school, Sammy and Rose. It is difficult to pay the school fees. Okello doesn't know what to do.

8. Now read the story while showing picture 3.



Sammy and Rose learn about the water bottle light in class. They make three water bottle lights. When Okello is at lunch they install them in the back of the shop. They light up the shelves.

Later Sammy and Rose ask Okello if today is different? Okello knows it is quieter because he did not hear the generator. Sammy and Rose point to the water bottle lights. Okello is surprised because he can still see everything at the back of the shop.

9. Now read the story while showing picture 4.



Later Okello gets 5 SSP to pay for the generator power. But he did not use generator power. The water bottle lights have saved him money. Okello gives Sammy and Rose the 5 SSP to pay for school fees.

10. Ask:

- What do we learn from this story?

11. Say:

- Sometimes simple ideas like a water bottle light can save us money for more important things like school fees.

## Activity 12: **Working Together**

1. Put learners into groups of 2.
2. Ask learners to retell the story.
3. Help learners who cannot remember.



## Activity 13: Role Play

1. Put learners into groups of 5.
2. Each learner takes a role from the story:
  - Boy
  - Girl
  - Okello
  - Friend with generator
  - Customer
3. Instruct the groups to act out the story.
4. Choose one group to act out the story in front of the class.

## Activity 14: Key Message

1. Ask learners if they remember the key message.
2. Write the key message on the blackboard.  
**Keep bleach out of reach of children.**
3. Read the message. Move your finger under each word as you read it.
4. Ask learners to say the message with you. Point to each word as you read it together.
5. Ask different learners to read the message.
6. Ask learners to come to the front and underline a word in the message such as: children, bleach, keep.
7. Ask learners to copy the message and draw a picture to go with it.

### Materials for activity 15:

Stones or sticks  
3 pots made from water bottles with a happy, normal and sad face

## Activity 15: Assessment

1. Put learners into groups of 2.
2. Ask each group of 2 learners to talk about the following questions:
  - What 2 things did you learn today?
  - What did you like doing the best?
  - What will you tell and show your family about today?
3. Ask some groups to share their answers with the class.
4. Say:
  - In the next session we learn how to make healthy water to drink.
  - We will need used plastic bottles.



- Each learner should try to bring 1 or 2 used plastic bottles to the next class.
5. Find three places on the floor or use 3 pots and mark them: happy face, normal face and sad face.
  6. Ask each learner to put a stone or stick next to the place that shows how they felt about the session.
  7. Write down how many learners put a stone next to each face in order to keep track of which lessons work well and which lessons could be improved.

# Session 7: Healthy Water

**Message:** Drink healthy water, use filtering and SODIS.

## Important words:

**SODIS:** water treatment using the ultraviolet rays of the sun

**Ultra violet light or UV light:** Light we cannot see from the sun

## English Vocabulary:

- weather
- sunny
- cloudy
- windy
- rainy
- rainbow
- red
- orange
- yellow
- green
- blue
- indigo
- violet

## English Phrases:

What is the weather?  
What colour is this?

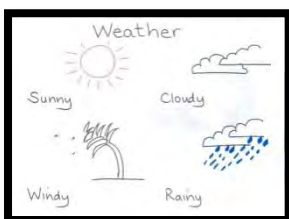

**Before you begin, place a bottle of SODIS water on the roof in the morning or the day before.**

## Activity 1: Introduction

1. Ask

- What did you learn in the last session?
- What did we make in the last session?
- What did we use to make it?
- What did you do with the things you made in the last session?
- Can you tell the class about it?

2. Say:

- Today we will learn how we can make our water healthier to drink and reduce the germs that cause diarrhoea and other illness.
- We will also look at weather and sunlight.

3. Ask:

- Where do you get your drinking water from?
- Is your drinking water safe to drink?

## Activity 2: Weather

1. Ask:

- What is the weather today?
- What types of weather do we have in South Sudan?

2. Hold up the chart: **Weather**.

3. Read the title. Move your finger under each word as you read it.

4. Point to a picture and ask: What is the weather?

5. Say:

- Let's learn the English words.

6. Point to the words for each picture in turn and say:

- It is **sunny**.
- It is **cloudy**.

- It is **windy**.
- It is **rainy**.

7. Point to a picture and ask:

- What is the weather?
- Learners should respond in English: It is \_\_\_\_\_ .

8. Repeat with 5-10 learners.

9. Select a learner. Say:

- Find **sunny**.
- Find **cloudy**.
- Find **windy**.
- Find **rainy**.

10. Repeat with 5-10 learners.

11. Take the pack of coloured pencils and spread them on the floor.

12. Take a red pencil and draw the outline of a rainbow.

13. Say:

- This is red.

14. Repeat for the other colours of the rainbow: red, orange, yellow, green, blue, indigo (dark blue) and violet (light purple).

15. Ask:

- Who can tell me what this is? (rainbow)
- What colours makes a rainbow?

16. Say:

- A rainbow has 7 colours that we can see.

17. Point to each colour in turn and say: red, orange, yellow, green, blue, indigo (a dark blue) and violet (light purple).

18. Say:

- Let's learn the English words.

19. Point to the pencils for each colour in turn and say:

- This is **red**.
- This is **orange**.
- This is **yellow**.
- This is **green**.
- This is **blue**.
- This is **indigo**.
- This is **violet**.

20. Point to a coloured pencil and ask:

- What colour is this?
- Learners should respond in English: This is \_\_\_\_\_ .

**Materials for  
activity 2:**

Coloured pencils

A4 paper

21. Repeat with 5-10 learners.

22. Select a learner. Say:

- Find **yellow**.
- Find **red**.
- Find **green**.
- Find **violet**.
- Find **orange**.
- Find **blue**.
- Find **indigo**

23. Repeat with 5-10 learners.

## Activity 3: **Beat the Words**

1. Say the first vocabulary word. Ask the learners to repeat it after you.

2. Say:

- Listen while I clap the syllables in this word.

### **Teaching Syllables:**

#### **Syllables in Vocabulary Words**

- **wea / ther:** 2 syllables = 2 claps
- **sun / ny:** 2 syllables = 2 claps
- **clou / dy:** 2 syllables = 2 claps
- **win / dy:** 2 syllables = 2 claps
- **rai / ny:** 2 syllables = 2 claps
- **rain / bow:** 2 syllables = 2 claps
- **red:** 1 syllable = 1 clap
- **blue:** 1 syllable = 1 clap
- **green:** 1 syllable = 1 clap
- **yel / low:** 2 syllables = 2 claps
- **o / range :** 2 syllables = 2 claps
- **vi / o / let:** 3 syllables = 3 claps
- **in / di / go** 3 syllables = 3 claps

3. Say the word again while clapping the syllables.

4. Repeat with learners.

5. Ask learners to identify the number of syllables in the word.

6. Use your fingers to count the number of syllables together with the class.

7. Repeat with the other vocabulary words.

## Activity 4: UV Light

1. Show the picture of the rainbow.

2. Say:

- The light from the sun includes visible light and colours we can see. It also has invisible light that we cannot see.

3. Draw a line beneath violet.

4. Say:

- Next to violet in the rainbow are rays called ultra violet or UV light.
- UV light is important. It is helpful and harmful to people.
- UV light makes vitamin D in our bodies which helps us to grow strong bones.
- UV light can also damage objects. When we leave a book in the sunlight the colours fade.
- UV light can also damage our skin and eyes.
- When we stay in the sunlight for too long, it changes the colour of our skin and makes it darker.
- UV light can also kill bacteria and germs in water.

5. Ask:

- Has anyone seen their skin turn darker after being in the UV light of the sun?
- Has anyone seen a book change colour in UV light of the sun?
- What else can change colour in UV light?



6. Say:

- Paper, cloth and plastic can change colour in the sun. They have been damaged by the UV light.

7. Use the chart **SODIS**.

8. Read the title. Move your finger under each word as you read it.

9. Ask:

- What do you see in this picture?
- What do you think is happening?
- What do you think will happen next?

10. Say:

- It is sunny and the light rays are hitting the bottle of water.

- UV light rays can kill the germs in water that cause diarrhoea.
- We use UV light rays to disinfect water.

11. Ask the learners to look at the label on a bottle of water and find the letters UV.

12. Point the section on the water bottle label that has UV. Read out the sentence about UV light.

13. Say:

- The water we buy in South Sudan has been treated using UV light rays.
- We call it Solar water disinfection or SODIS.
- SODIS has been tested and is safe<sup>1</sup>.
- SODIS is very good to treat small amounts of water cheaply using sunlight
- The sunlight treats water by UV light rays and increasing the water temperature.

## Activity 5: Methods to Treat Water

1. Ask:

- How can we treat water to make it safer to drink?

2. Use the chart **Water treatment**

3. Read the title. Move your finger under each word as you read it.

4. Ask:

- What do you see in this picture?
- What do you think is happening?

5. Say:

- There are several methods that can be used to treat water and make it safer:

6. Point to the picture **Store**. Say:

- Storing water for 2 days will kill or greatly reduce most harmful bacteria. Containers must be covered to prevent algae growth, and insects and dust.

7. Point to the picture **Boil**. Say:

- Boiling the water is the best way: boiling water for just 1 minute is enough. Or for 10 minutes at 60° C.

8. Point to the picture **Filter**. Say:

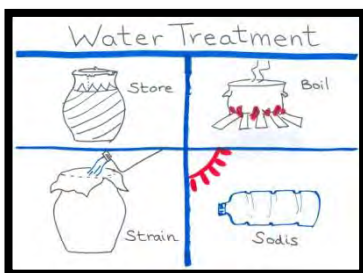

<sup>1</sup> SODIS was developed and tested at the Swiss Federal Institute for Aquatic Science and Technology (Eawag) by its Department of Water and Sanitation in Developing Countries (Sandec).

- Filtering water through cloth can reduce cholera by up to 50% and is helpful protection against guinea worm.

9. Point to the picture **SODIS**. Say:

- Solar disinfection: Using UV light to disinfect the water can reduce diarrhoea from 20-50%.

10. Ask:

- Are there any other ways to treat water to make it safe?

11. Say:

- We can use chemicals like chlorine which is very effective but muddy water must be filtered first.

12. Ask:

- Where does your family get their water?
- What colour is it?
- Do you like drinking dirty water?
- Is dirty water healthy water?
- How can we remove the dirt from water?

13. Say:

- We can remove dirt from water 2 ways.
- Keeping the water in a large pot for 2 days allows the dirt to sink to the bottom. The water at the top is cleaner and nicer to drink.
- We can filter the dirty water by pouring it through cloth to remove the dirt.

14. Read out the key message:

**Drink healthy water. Use filtering and SODIS.**

15. Repeat with learners.

16. Say the key message to the music beat.

17. Repeat with learners.

### Materials for activity 6:

Toolkit  
2 bottles of river water  
5 clear plastic bottles  
3 pieces of fine weave cotton cloth  
1 piece loose cloth (sacking)  
Piece of A4 paper  
Rubbish bin

## Activity 6: Experiment on Filtering Water

1. Put the learners into a large circle.

2. Show 2 bottles of dirty river water (shake it before you show the learners).

3. Ask:

- What colour is this water?
- Is the water clean and clear?
- What makes the water dirty?



4. Draw a red cross on a piece of paper. Put it under a bottle.
5. Say:
  - If the water is clean we will be able to see writing on the paper underneath the bottle.
  - We look through the top of the bottle.
6. Ask 2 learners to come to the front and look through the bottles. Ask if they can see the writing.
7. Say:
  - If we cannot see the cross clearly the water is not clean.
8. Say:
  - We will see if storing the water will help to clean it.
  - I will leave 1 bottle of water undisturbed for 2 days.
9. Ask:
  - After 2 days, will we be able to read the paper looking through the top of the bottle?
  - Write the answers on a paper.
  - Put the paper by the bottle to check after 2 days.
10. Say:
  - I want to see if filtering will clean the water.
  - We need to use 4 funnels and pots for this experiment.
7. Ask for 4 learners to volunteer to make the funnels and cups.
8. Thank the learners.
9. Follow the instructions for an experiment on filtering water.
10. Show 4 pots and 4 funnels.
11. Show 2 pieces of material – one with a loose weave (grain sack) and one with a tight weave (old cotton bed sheeting).
12. Pass the materials around the circle of learners.
13. Ask some learners to describe the pieces of cloth.
14. Say:
  - The grain sack has loose threads. The cotton bed sheeting has tight threads.
15. Put the grain sack cloth in one funnel and the cotton cloth in another.
16. Say:
  - I will pour the water through the cloth. Which will be best at cleaning the water? Grain sack or cotton?
17. Pour dirty water into each funnel and pot.

18. Show the learners the pots after filtering the water.

19. Ask:

- Which material was best at cleaning the water?

20. Ask 2 learners to look through the top of the pot to read the paper underneath. Can they see the writing?

21. Say:

- The tight weave cotton was better at cleaning water as it has very small gaps between the threads.
- The loose weave cloth let more dirt through as it had big gaps between the threads.

22. Ask:

- How can we make the filtering better?

23. Show 2 pieces of cotton cloth. Fold each piece of cloth into in half and half again so there are 4 layers of cotton.

24. Take one piece and count the layers of cloth. Put it (4 layers) in a funnel. Mark the pot 4.

25. Take the other piece of cloth. Fold it in half and half again so there are 16 layers of cotton. Count the layers of cloth. Put it in a funnel. Mark the pot 16.

26. Ask:

- Which pot will have the cleanest water? The one with 4 layers of cloth or the one with 16 layers of cloth?

27. Pour dirty water into each funnel and pot.

The filtering using 16 layers of cloth takes a much longer time. Ask a learner to do this for you as you ask learners to draw the pictures of how to treat water.

28. Show the learners the pots after filtering the water.

29. Ask:

- Which was best at cleaning the water? 4 or 16 layers of cloth?

30. Ask 2 learners to look through the top of the pots to read the paper underneath. Can they see the writing?

31. Say:

- The more pieces of cloth we use for filtering, the cleaner the water.

- Remember that we must wash the dirt off the cloth and dry it before we can use it again.
- We can filter our water when we collect it or when we get back home. Choose which is easiest.

32. Keep the water that is clean enough to read the writing on the paper underneath the pot.

33. Read out the key message:

**Drink healthy water. Use filtering and SODIS.**

34. Repeat with learners.

35. Say the key message to the music beat.

36. Repeat with learners.

**Materials for activity 7:**

Range of plastic and glass bottles

Small and large jerry can

Dirty and clean bottles

Some bottles without lids

## Activity 7: Which Bottle is Best?

1. Put the learners into a large circle.

2. Put lots of different bottles in the middle.

- Clean bottles
- Dirty bottles
- Coloured bottles
- Small bottles
- Glass bottles
- Plastic bottles
- Small jerry can
- Jerry can

3. Point to the item and ask:

- What is this?
- What colour is it?  
What is it made of?
- Where can I find it?

Learners should respond in English:

- This is glass / plastic.
- This is clear / brown / green.
- This is clean / dirty.

4. Repeat with each bottle.

5. Say:

- For the SODIS method we need bottles that the UV light can go through.

6. Ask:

- Which bottles are best to use?
- Why?

7. Ask a learner to sort the bottle into good ones to use for SODIS and bottles that are not good.

8. Say:

- The best bottles for SODIS are:
  - Undamaged with a good lid
  - Transparent that means they are clear and we can easily see through them.
  - We can use clear glass bottles which have good lids but they may break and are heavy.
  - Clear plastic bottles which have a bluish tinge.
  - Bottles up to 3 litres in size.
- Do not choose coloured or badly scratched bottles.
- Remember to remove the labels on the bottles.
- The best bottles for SODIS are large plastic water bottles.

9. Ask a learner to check we have sorted out the best bottles.

10. Ask another learner to put the bottles in order of size.

11. Say:

- The amount of water a bottle can hold is the capacity of the bottle. We measure capacity using litres. A litre is made up of 1000 millilitres.

12. Show a small water bottle. Read and show the capacity on the label. Write the capacity in ml on the board (700ml)

13. Repeat for bottles of 1 Litre (1 L) and 1.5 Litres (1.5L).

14. Show a large bottle (over 3 litres) such as a cooking oil container, which has no label telling the capacity.

15. Ask:

- How can we check if this bottle is less than 3 litres when the label is missing?

16. Say:

- We can use 2 bottles that are 1.5 litres to fill the large bottle.

17. Ask a learner to use the 2 bottles of 1.5 Litres to fill the large bottle.

18. Say:

- If there is still room for more water the bottle is over 3 litres and is too big for SODIS to be effective.
- If we cannot put all the water in, the bottle is under 3 litres so it is good for SODIS.

- Now that we have selected the best bottles we can make healthy water.

**Materials for activity 8:**

Plastic bottles

Omo

Filtered water from activity 6

Funnel

## Activity 8: Preparation

1. Put the learners into a large circle.
2. Say:
  - We are going to prepare water using the SODIS method.
3. Show the items needed to use the SODIS method.
  - Large clear plastic bottles
  - Filtered water from activity 6
  - Omo
4. Say:
  - Let's learn the English words.
5. Point to each item in turn and say:
  - This is a **bottle**.
  - This is **water**.
  - This is a **omo**.
6. Point to the item and ask:
  - What is this?
  - Learners should respond in English: This is a \_\_\_\_\_ .
7. Repeat with 5-10 learners.
8. Ask:
  - Is the space safe?
  - Is your body safe? Are you dressed correctly?
8. Remind the learners of the Skills for Life Plus rules.
9. Ask the learners to make their body and the space safe.

**Materials for activity 9:**

Clear plastic bottles

Omo

Filtered water from activity 6

Funnel

## Activity 9: Demonstration

1. Say:
  - I am going to show you how to use the SODIS method to make healthy water.
  - Look carefully at what I do.
2. Say:
  - Remember:
  - SODIS means Solar disinfection.

- The UV rays in sunlight kill viruses, bacteria and parasites in water like giardia and cryptosporidia making it safer to drink.
  - SODIS can reduce diarrhoea by 20-50%.
  - All that is required is a clear plastic water bottle, heat from the sun, and about 6 hours.
3. Follow the instructions for the SODIS method up to step 3.
  4. Take the learners outside and find a safe place on a roof to put the bottle. Make sure it does not roll off.
  5. Collect the bottle of SODIS water you put on the roof in the early morning.
  6. Drink from the bottle to show that the water is now safe.

It is very important that the teacher drinks the SODIS water. Then the learners will believe it is safe.

7. Say:

- Sometimes the weather is not sunny. Here are the rules of SODIS.
- Put the SODIS bottle in the sun from morning to evening.
  - 1 full day when the sky is clear.
  - 1 full day if less than half of the sky is covered in clouds.
  - 2 full days when more than half the sky is covered in clouds.

**Remember:**

- Clouds affect the strength of UV light rays and make them weaker. So we need more time to make healthy water.
- SODIS does not work well during rainy days. Instead collect rain water or boil water.

8. Read out the key message:

**Drink healthy water. Use filtering and SODIS.**

9. Repeat with learners.

10. Say the key message to the music beat.

11. Repeat with learners.

# How to make healthy water<sup>2</sup>

## Materials

Plastic bottles  
Omo  
Filtered water  
Funnel

1. Take a clear plastic water bottle. Clean it with soap or omo the first time you use it.



2. Only clear water can be used for SODIS. Dirty water reduces the efficiency of sunlight.  
Dirty water has to be filtered through a clean cloth before it can be used for SODIS.
3. Fill the bottle  $\frac{3}{4}$  with water.



4. Shake the bottle for 20 seconds.
5. Then fill up the bottle. Close the lid tightly.

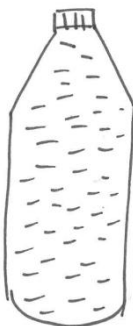

---

<sup>2</sup> SODIS was developed and tested at the Swiss Federal Institute for Aquatic Science and Technology (Eawag) by its Department of Water and Sanitation in Developing Countries (Sandec). It is promoted worldwide through local partner organisations.

6. Place the bottle in the sun in the morning on the roof.  
The bottles should be flat and be in the sun for the whole day.  
Shadows must not fall on the bottle.

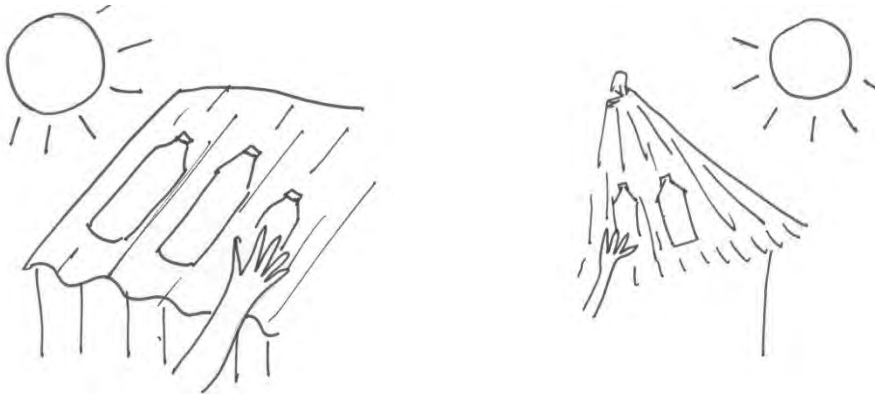

7. After 6 hours in the full sun the water is safe to drink!
8. Drink or use the water direct from the bottle or a clean glass.



9. Keep the treated water in the bottle.  
Do not pour SODIS treated water into another bottle as it may become contaminated or dirty again.



**Materials for  
activity 10:**

Toolkit

Bottles

Cotton cloth

Omo

Rubbish bin

## Activity 10: Using the SODIS Method

1. Put the learners into 5 groups.
2. Ask the learners to hold up the materials they brought to use the SODIS method. Remember you will need to check the water first. If you cannot read the paper from the top of the bottle of water you will need to filter the water.
3. Say:
  - If your group has lots of bottles then you can make one each.
  - If your group only has a few bottles, everyone in the group will work together to make one.
  - Decide who will
    - Make the funnel
    - Filter the water
    - Clean the bottle
    - Fill and shake the bottle
    - Put the bottle on the roof
4. Give a toolkit to each group
5. Say:
  - Each group can make their SODIS water.
  - Come to me when you need the omo.
6. Monitor the groups and provide help when needed. Make comments to the group:
  - I like the way you are helping each other.
  - I like the way that you being careful with the omo.
  - I like the way you are being careful with the scissors.
7. When everyone has finished collect the tools.
8. Ask each group to mark their bottle and put it on the roof.
9. Ask:
  - How long should we leave the SODIS bottles on the roof?
- 10 Ask:
  - How do you feel now that you have started making healthy water?

## Activity 11: Story

1. Use the chart **Sarah feels better**
2. Show the first picture.
3. Ask:
  - What do you see in this picture?

- What do you think is happening?
- What do you think will happen next?

4. Show the next picture.

5. Ask the questions again.

6. Now read the story while showing picture 1.



Sarah lives in a small village with her husband and children. She often suffers from diarrhoea and pains in her stomach. She went to the doctor. He advised Sarah to drink boiled water.

Sarah did not have money to buy wood or charcoal to boil water. She continued to be ill. She worried that her baby would become ill too.

7. Now read the story while showing picture 2.



One day a nurse told Sarah about the SODIS method. Sarah followed the instructions to make SODIS water and drank it every day.

8. Now read the story while showing picture 3.



Over the next few weeks and months Sarah felt much better. She did not suffer from diarrhoea. She knew the SODIS water was good for her health. Now Sarah always uses the SODIS method for her drinking

water. She gives it to her baby. She no longer worries that the water will make the baby or herself sick.

9. Ask:

- What do we learn from this story?

10. Say:

- Sometimes simple ideas like SODIS can make us feel healthy and save us money for more important things.

## Activity 12: **Working Together**

1. Put learners into groups of 2.
2. Ask learners to retell the story.
3. Help learners who cannot remember.

## Activity 13: **Role Play**

1. Put learners into groups of 5.
2. Each learner takes a role from the story:
  - Sarah
  - Doctor
  - Nurse
3. Instruct the groups to act out the story.
4. Choose one group to act out the story in front of the class.
5. Read out the key message:  
**Drink healthy water. Use filtering and SODIS.**
6. Repeat with learners.
7. Say the key message to the music beat.
8. Repeat with learners.

## Activity 14: **Discussion**

1. Put learners into groups of 4.
2. Ask each group to discuss the advantages of using SODIS water treatment.
3. Ask some groups to give their ideas.

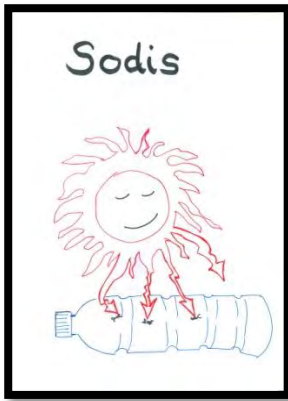

4. Say:

- SODIS water can help prevent waterborne diseases like diarrhoea, dysentery, cholera and typhoid.
- It improves your family health situation.
- It does not change the taste of the water.
- It is simple to use and free of cost.
- People can use the SODIS method to treat their drinking water themselves.
- The method is very simple and it is safe.
- It is very good for treating small quantities of drinking water.
- The method also works when the air and water temperatures are low. It just needs sun.
- It reduces fuel expenses and health costs.

5. Show the chart of the sun's UV radiation killing germs in the water bottle again.

6. Ask each learner to draw a poster to tell people about SODIS.

## Activity 15: Key Message

1. Ask learners if they remember the key message.

2. Write the key message on the blackboard.

**Drink healthy water. Use filtering and SODIS.**

3. Read the message. Move your finger under each word as you read it.

4. Ask learners to say the message with you. Point to each word as you read it together.

5. Ask different learners to read the message.

6. Ask learners to come to the front and underline a word in the message such as: water, SODIS, healthy

7. Ask learners to copy the message and draw a picture to go with it.

### Materials for activity 16:

Stones or sticks

3 pots made from water bottles with a happy, normal and sad face

## Activity 16: Assessment

1. Put learners into groups of 2.

2. Ask each group of 2 learners to talk about the following questions:

- What 2 things did you learn today?
- What did you like doing the best?
- What will you tell and show your family about today?

3. Ask some groups to share their answers with the class.

4. Say:

- In the next session we learn how to make a Tip-Tap.
- We will need small jerry cans, stones and string.
- Each learner should try to bring some of these items to the next session.



5. Find three places on the floor or use 3 pots and mark them: happy face, normal face and sad face.

6. Ask each learner to put a stone or stick next to the place that shows how they felt about the session.

7. Write down how many learners put a stone next to each face in order to keep track of which lessons work well and which lessons could be improved.

# Session 8: Tip-Tap

**Message:** Wash your hands with soap and clean water.

## Important words:

**Machine:** a tool containing one or more parts that does a job better and faster and more powerfully than a human being.

## English Vocabulary:

- pivot
- lever
- load
- force
- ruler
- pencil

## Materials for activity 2:

Ruler  
Pencil  
Bottle top  
Scissors

## Activity 1: Introduction

1. Ask

- What did you learn in the last session?
- What did we make in the last session?
- What did we use to make it?
- What did you do with the things you made in the last session?
- Can you tell the class about it?

2. Say:

- Today we learn how to make a simple machine that will provide water to wash our hands.
- We will also look at simple machines and how they can make our work easier.

3. Ask:

- How do you wash your hands?
- Where do you wash your hands?

## Activity 2: Vocabulary

1. Put the learners into a large circle.

2. Say:

- We are going to prepare for a maths experiment.

3. Show the items needed for the experiment.

- ruler
- pencil
- scissors
- bottle tops

4. Say:

- Let's learn the English words.

5. Point to each item in turn and say:

- This is a **ruler**.
- This is a **pencil**.
- This is a **bottle top**.
- These are **scissors**.

6. Point to the item and ask:

### Materials for activity 2:

Make large word cards for each of the following words: ruler, pencil, bottle top, scissors,

- What is this?
- Learners should respond in English: This is a \_\_\_\_\_ .

7. Repeat with 5-10 learners.

8. Select a learner. Say:

- Find the **bottle top**.
- Find the **ruler**.
- Find the **pencil**.
- Find the **scissors**.

9. Repeat with 5-10 learners.

10. Show a word card and read the word.

11. Ask a learner to put the word card by the item it describes.

12. Repeat with different learners.

13. Repeat for all the word cards.

### Materials for activity 3:

Ruler

15-20 bottle tops

Pencil

Scissors

## Activity 3: Science

1. Put the learners into a large circle.

2. Say:

- We use simple machines to make difficult jobs easier.
- Today we will look at pivots or turning points, and levers.

3. Make a seesaw by putting a pencil under the middle of the ruler.

4. Place 5 bottle tops, half way between one end of the ruler and the pencil.

5. Ask:

- I want the ruler to balance. How many bottle tops should I put on the other end of the ruler?
- Show the number of bottle tops using your fingers.

6. Check the fingers that the learners show.

7. Ask a few learners to tell you how many bottle tops and why they think this number.

8. Ask a learner to come to the front. Ask them to put bottle tops one at a time on the end of the ruler.

9. Count the bottle tops as they go on the ruler.

10. When the ruler is balanced count how many bottle tops were needed to lift the pile of 5 bottle tops.

11. Ask:

- How many learners guessed the right answer?

12. Say:



- It takes less than 5 bottle tops to balance the ruler. The ruler on the pencil acts as a lever, magnifying the weight of the bottle tops furthest away from the pencil.
- The ruler acts as the lever. The pencil acts as a pivot or turning point.

13. Ask:

- What happens if I move the smaller pile of bottle tops nearer the pivot (the pencil)?
- Will they still lift the pile of 5 bottle tops?
- Will I need more or less bottle tops?
- How many bottle tops will I need to lift the pile of 5 bottle tops when I move them closer to the pivot?

14. Move the second pile of bottle tops closer to the pivot (pencil).

15. Ask a learner to come to the front. Ask them to put bottle tops one at a time on the end of the ruler.

16. Count the bottle tops as they go on the ruler.

17. When the ruler is balanced count how many bottle tops were needed to lift the pile of 5 bottle tops.

18. Say:

- To lift the 5 bottle tops, we need more bottle tops close to the pencil and fewer bottle tops furthest way from the pencil.

19. Say:

- Now we will put what we have learnt into practice.

20. Take the pencil away.

21. Put a small heavy object, like a scissors or knife on the end of the ruler.

22. Ask a learner to use the ruler to lift the scissors.

23. Ask:

- Is it easy or difficult to lift the scissors?

24. Say:

- Now we will use a pivot under the ruler.

25. Take the pencil and place it under the ruler at a point far from the scissors.

26. Ask a learner to come to the front and press down on the opposite end of the ruler from the scissors.

27. Ask:

- Is it easy or difficult to lift the scissors?





28. Ask the learner to move the pencil to different positions under the ruler and test which position is easier to lift the scissors.

29. Ask:

- Which is the best position for the pivot (pencil) to lift the scissors easily?



30. Draw the picture on the board.

31. Say:

- The pencil makes it easier to lift up the scissors, when it is close to the object.
- The scissors is the **load** to be lifted.
- The pencil is the turning point called the **pivot**.
- The ruler is the **lever**.
- The push on the ruler is the **force** needed to lift the load (scissors).
- Using a level and pivot reduces the force we need to move a load.
- Using a pivot and a level makes our work easier.

32. Ask:

- How can pivots and levers help us in our home?

33. Say:

- We are going to use a pivot in a simple machine called a Tip-tap. It will tip water on both our hands so we can wash them.

## Activity 4: Beat the Words

1. Say the first vocabulary word. Ask the learners to repeat it after you.

2. Say:

- Listen while I clap the syllables in this word.

### Teaching Syllables:

#### Syllables in Vocabulary Words

- **Tip / Tap:** 2 syllables = 2 claps
- **pi / vot:** 2 syllables = 2 claps
- **le / ver:** 2 syllables = 2 claps
- **ma / chine:** 2 syllables = 2 claps
- **load:** 1 syllable = 1 clap
- **force:** 1 syllable = 1 clap
- **ru / ler:** 2 syllables = 2 claps

- **pen / cil:** 2 syllables = 2 claps

3. Say the word again while clapping the syllables.
4. Repeat with learners.
5. Ask learners to identify the number of syllables in the word.
6. Use your fingers to count the number of syllables together with the class.
7. Repeat with the other vocabulary words.

**Materials for  
activity 5:**

10 stones

## Activity 5: **Number Bonds for 10**

1. Put the learners into a large circle.
2. Show the 10 stones.
3. Say:
  - Let's count the stones: 1, 2, 3, 4, 5, 6, 7, 8, 9, 10.
4. Repeat.
5. Ask a learner to come to the front and count the stones.
6. Repeat with 2 more learners.
7. Say:
  - We need more stones.
8. Ask each learner to go outside and bring 10 stones.
9. Ask the learners to place their stones in a line and count the stones.
10. Show the 10 stones.
11. Say:
  - I will take some stones and hide them in my hand
  - Then you tell me how many stones are hiding.
12. Pick up 3 stones and put them behind your back.
13. Say:
  - Let's count the stones left.
14. Say:
  - I have 7 stones. How many are hiding?
15. Ask some learners for their answers.
16. Say:
  - I have 7 stones left and 3 hiding. 7 plus 3 equals 10.
17. Repeat steps 11 to 16 hiding a different number of stones each time.
18. Put the learners in groups of 2.

19. Ask one learner to hide the stones and the other learner to guess how many are hiding.

20. Take it in turns to hide the stones.

## Activity 6: Tip-Tap

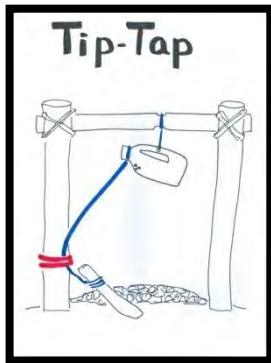

### Materials for activity 6:

Make large word cards for each of the following words: stick, string, stone, jerry can, Tip-Tap

1. Put the learners into a large circle.

2. Say:

- A Tip-Tap is a simple way to tip water on your hands to wash them.
- It is operated by your foot and not your hands. Because we don't put our dirty hands in the water or on a cup or tap, it reduces contamination of the water and the spread of disease.
- The Tip-Tap only tips the water you need so it conserves water. This means we use less water.
- The Tip-Tap is made from local or recycled materials.

2. Show the picture chart of a Tip-Tap.

3. Read the title. Move your finger under each word as you read it.

4. Point to the materials and ask:

- What is this?
- Learners should respond: This is a \_\_\_\_\_ .

5. Say:

- Let's learn the English words.

6. Point to each item in turn and say:

- This is a **stick**.
- This is a **small jerry can**.
- This is **string**.
- This is a **stone**.
- This is a **Tip-Tap**

7. Point to the item and ask:

- What is this?
- Learners should respond in English: This is a \_\_\_\_\_ .

8. Repeat with 5-10 learners.

9. Select a learner. Say:

- Find the **stick**.
- Find the **stone**.
- Find the **string**.
- Find the **jerry can**.
- Find the **Tip-Tap**

10. Repeat with 5-10 learners.
11. Show a word card and read the word.
12. Ask a learner to put the word card by the item it describes.
13. Repeat for all the word cards.
14. Name the parts of the Tip-Tap.
15. Say:
  - This is the jerry can with water inside.
  - These are the holes the water comes out.
  - This is the pivot.
  - This is the pulling string.
  - This is the foot pedal.
16. Say:
  - To use the Tip-Tap, place your foot on the foot pedal.
  - The stick pulls the string down, pulling the top of the jerry can down.
  - The water pours out of the holes.
17. Ask:
  - Where is a good place to put a Tip-Tap?
18. Say:
  - A good place for a Tip-Tap is near the latrine, near where you eat, and near the kitchen.
19. Read out the key message:
 

**Wash your hands with soap and clean water.**
20. Repeat with learners.
21. Say the key message to a music beat.
22. Repeat with learners.

**Materials for activity 7:**

2 large sticks: 120 cm

2 small sticks: 60 cm

Small jerry can

Strong string

Stones

Toolkit

## Activity 7: Preparation

1. Put the learners into a large circle.
2. Say:
  - We are going to prepare to make a Tip-Tap.
3. Show the items needed to make a Tip-Tap.
  - 2 large sticks about 120 cm long.
  - 2 small sticks 60-100 cm long
  - Small jerry can
  - Strong string, not plastic
  - Scissors
  - Knife

- Nail
- Stones
- Rubbish bin

4. Ask:

- Is the space safe?
- Is your body safe? Are you dressed correctly?

5. Remind the learners of the Skills for Life Plus rules.

6. Ask the learners to make their body and the space safe.

## Activity 8: **Demonstration**

1. Say:

- I am going to show you how to make a Tip-Tap.
- Look carefully at what I do.

2. Say:

- Remember: Use a rubbish bin.

3. Say:

- First we need to find the place for the Tip-Tap.
- The place may already have a structure we can use for the Tip-Tap.

4. Follow the instructions to make a Tip-Tap.

### **Materials for activity 8:**

2 large sticks: 120 cm

2 small sticks: 60 – 100 cm

Small jerry can

Strong string

Stones

Toolkit

### **Making a Tip-Tap in the classroom**

Instead of pushing the sticks in the ground, ask 2 learners to hold them.

Make the Tip-Tap but do not put water in the small jerry can.

5. When you have finished put all the waste pieces in the rubbish bin.

6. Read out the key message:

**Wash your hands with soap and clean water.**

7. Repeat with learners.

8. Say the key message to a music beat.

9. Repeat with learners

10. When you have finished use the Tip-Tap to wash your hands.

# How to make a Tip-Tap

## Materials

Toolkit  
2 big sticks  
2 small sticks  
Small jerry can  
Strong string  
Stones

1. First decide on the place to build the Tip-Tap. A good place is next to the latrine.
2. Push one big stick into the ground about 30 cm deep if possible. Make a small hole to help you. If you have a hammer or big stone you can use it to help you push the stick in the ground. Firm the soil around the stick well so the stick doesn't move.
3. If the ground is very hard, put water on it.
4. Push the other stick into the ground about 60 cm away.
5. Take a small stick. Cut a notch in the middle of the stick. This will stop the string from slipping.
6. Tie one small stick to the top of the two big sticks with string.
7. Make sure you tie it tight and that the sticks all feel firm and sturdy.
8. Take the jerry can. Carefully push the nail through the handle of the jerry can. This will be the pivot. Some jerry cans can use the handle as the pivot.
9. Make three holes to let the water pour out.
10. Make a hole in the handle to let air in.
11. Thread string through the two holes in the handle or the handle of the jerry can.
12. Tie the jerry can to the notch in the stick. Do not tie it very tight. Make sure the jerry can is able to tip up and down.
13. Tie a length of string around the neck of the jerry can. Make sure the lid can still go back on. This is the main pulling string.
14. We need another string to tie the pulling string to the base of the stick.
15. Tie a loop of string around the big stick. Make sure the "pulling" string can easily move inside it.
16. Take the second small stick. This will be the foot pedal.
17. Tie the pulling string to the pedal stick so that it is about 30 cm from the ground. One end is next to the big upright stick and the other end is touching the ground away from the structure. This is the foot pedal.

18. Test the foot pedal to make sure it tips the jerry can.
19. Dig a hole under the jerry can.
20. Fill the hole with small stones. This will prevent a muddy puddle under the jerry can.
21. Fill the jerry can with water. Use a funnel so that you do not spill any water.
22. Now your Tip-Tap is ready. Put your foot on the pedal and wash your hands using the water tipping out of the jerry can.
23. Afterwards you can add a soap dish made from a water bottle.

## Activity 9: Making a Tip-Tap

### Materials for activity 9:

Toolkit

Bleach

Bottles

Inner tube

Rubbish bin

1. Put the learners into 5 groups.
2. Ask learners to put all their materials (container, stones) together on the floor.
3. Say:
  - If your group has lots of materials then you can try to make one Tip-Tap each.
  - If you group only has a few materials everyone in the group will work together to make one Tip-Tap.
  - Decide who will:
    - Put in the sticks
    - Make the notch in a small stick
    - Tie the sticks
    - Make the holes in the jerry can
    - Tie the jerry can to the stick
    - Tie the pulling string
    - Tie the pedal stick
    - Dig the hole for drainage
    - Add the stones
4. Give a toolkit to each group.
5. Say:
  - Each group can make their Tip-Tap.
  - Remember to be careful with the nail and scissors.
6. Monitor the groups and provide help when needed. Make comments to the group:
  - I like the way you are helping each other.
  - I like the way that you being careful with the nail.
  - I like the way you are being careful tying the string.
7. When everyone has finished collect the tools.
8. Ask each group in turn to show their Tip-Tap working.
9. Ask:
  - How do you feel now that you have made a Tip-Tap?
  - Will you make a Tip-Tap for your home?
10. Say:
  - The Tip-Tap uses a pivot. The pivot can be the string on the handle or it can be a stick pushed through the container.
  - The Tip-tap can be made in many different ways. It depends on the container, and the sticks you have.
  - You may even be able to make a better Tip-Tap.



## Activity 10: Key Message

1. Ask learners if they remember the key message.
2. Write the key message on the blackboard.  
**Wash your hands with soap and clean water.**
3. Read the message. Move your finger under each word as you read it.
4. Ask learners to say the message with you. Point to each word as you read it together.
5. Ask different learners to read the message.
6. Ask learners to come to the front and underline a word in the message such as: hands, water, soap.
7. Ask learners to copy the message and draw a picture to go with it.

### Materials for activity 11:

Stones or sticks  
3 pots made from water bottles with a happy, normal and sad face



## Activity 11: Assessment

1. Put learners into groups of 2.
2. Ask each group of 2 learners to talk about the following questions:
  - What 2 things did you learn today?
  - What did you like doing the best?
  - What will you tell and show your family about today?
3. Ask some groups to share their answers with the class.
4. Say:
  - In the next session we learn how to make a trap for mice.
  - We will need large plastic bottles. A square shaped plastic bottle is best.
  - We also need some small sticks 1 hand length long.
  - Each learner should try to bring 1 or 2 used plastic bottles and sticks to class.
5. Find three places on the floor or use 3 pots and mark them: happy face, normal face and sad face.
6. Ask each learner to put a stone or stick next to the place that shows how they felt about the session.
7. Write down how many learners put a stone next to each face in order to keep track of which lessons work well and which lessons could be improved.

# How to make a Tip-Tap

## Materials

Toolkit  
2 big sticks  
2 small sticks  
Small jerry can  
Strong string  
Stones



First decide on the place to build the Tip-Tap. A good place is next to the latrine.

1. Push one big stick into the ground about 30 cm deep if possible. Make a small hole to help you. If you have a hammer or big stone you can use it to help you push the stick in the ground. Firm the soil around the stick well so the stick doesn't move.
2. If the ground is very hard, put water on it.

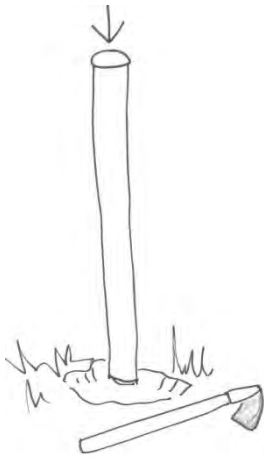

3. Push the other stick into the ground about 60 cm away.

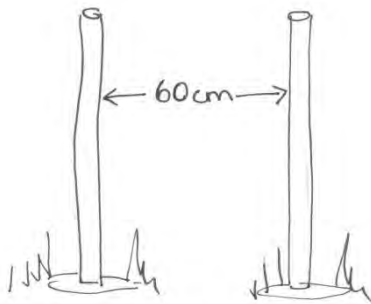

4. Take a small stick. Cut a notch in the middle of the stick. This will stop the string from slipping.
5. Tie one small stick to the top of the two big sticks with string. Make sure you tie it tight and that the sticks all feel firm and sturdy.

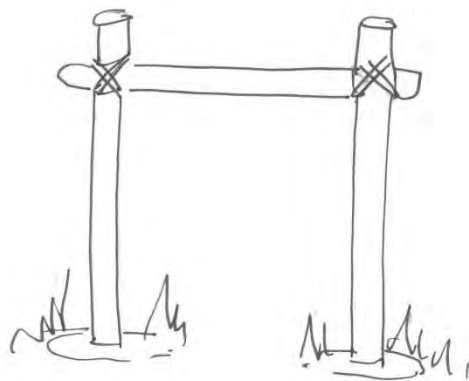

6. Take the jerry can. Carefully push the nail through the handle of the jerry can. This will be the pivot. Some jerry cans can use the handle as the pivot.

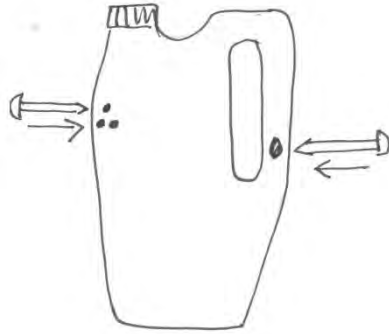

7. Make three holes to let the water pour out. Make a hole in the handle to let air in.

8. Thread string through the two holes in the handle or the handle of the jerry can.

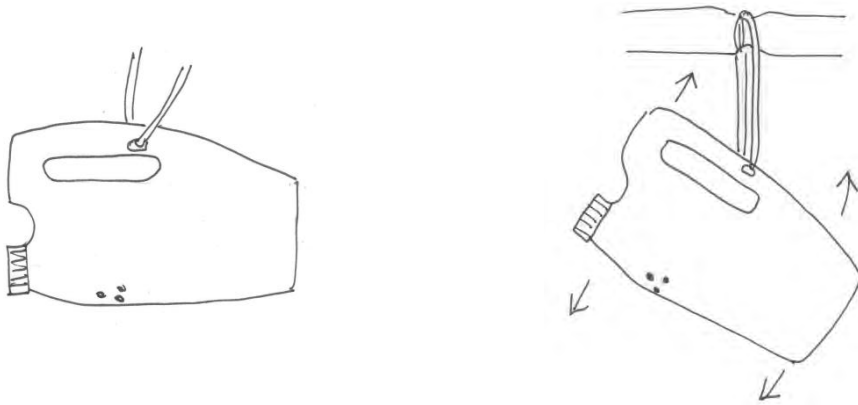

9. Tie the jerry can to the notch in the stick. Do not tie it very tight. Make sure the jerry can is able to tip up and down

10. Tie a length of string around the neck of the jerry can. Make sure the lid can still go back on. This is the main pulling string.

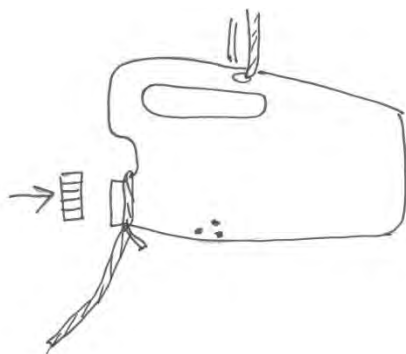

11. We need another string to tie the pulling string to the base of the stick.
12. Tie a loop of string around the big stick. Make sure the "pulling" string can easily move inside it.

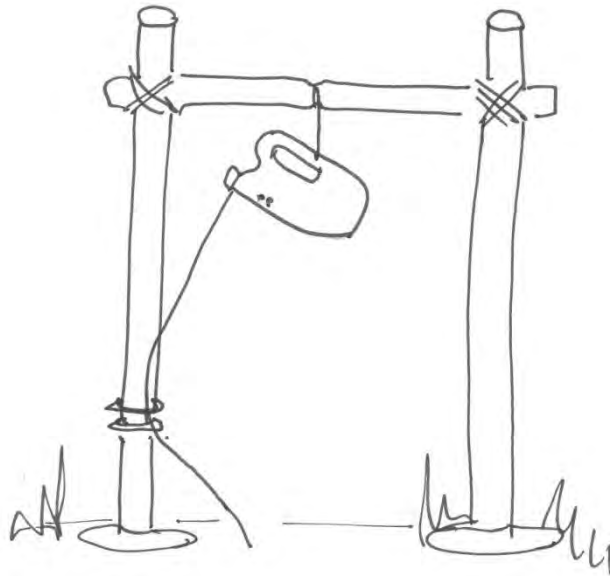

13. Take the second small stick. This will be the foot pedal.
14. Tie the pulling string to the pedal stick so that it is about 30 cm from the ground. One end is next to the big upright stick and the other end is touching the ground away from the structure. This is the foot pedal.

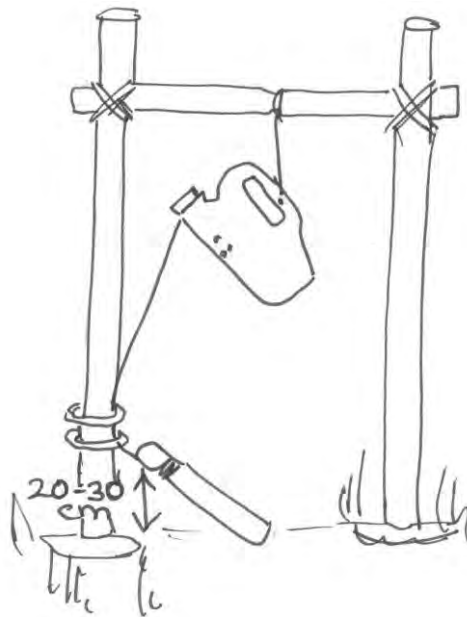

15. Test the foot pedal to make sure it tips the jerry can.

16. Dig a hole under the jerry can.

17. Fill the hole with small stones. This will prevent a muddy puddle under the jerry can.

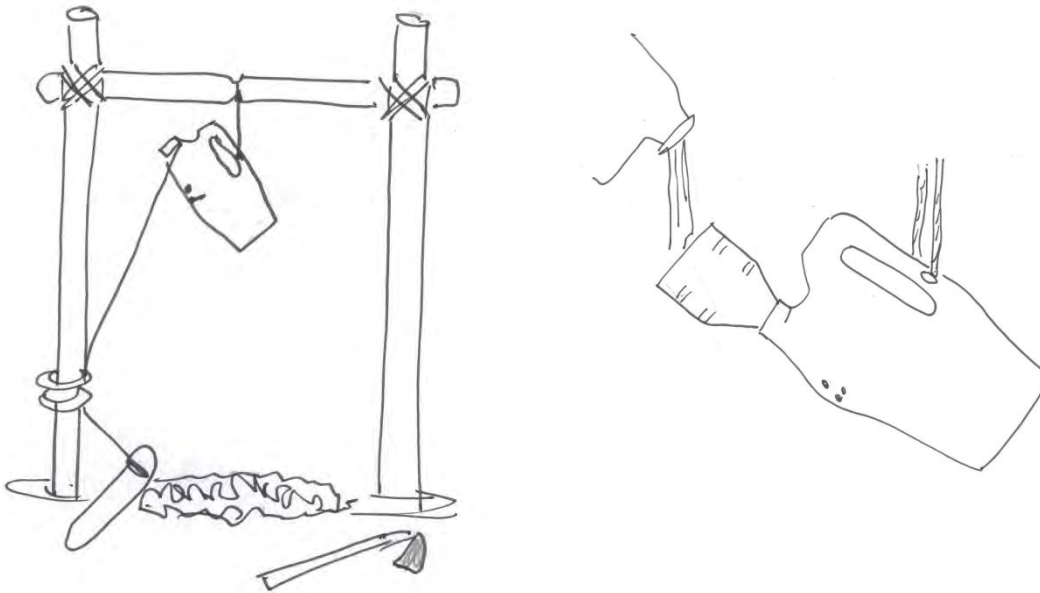

18. Fill the jerry can with water. Use a funnel so that you do not spill any water.

19. Now your Tip-Tap is ready. Put your foot on the pedal and wash your hands using the water tipping out of the jerry can.

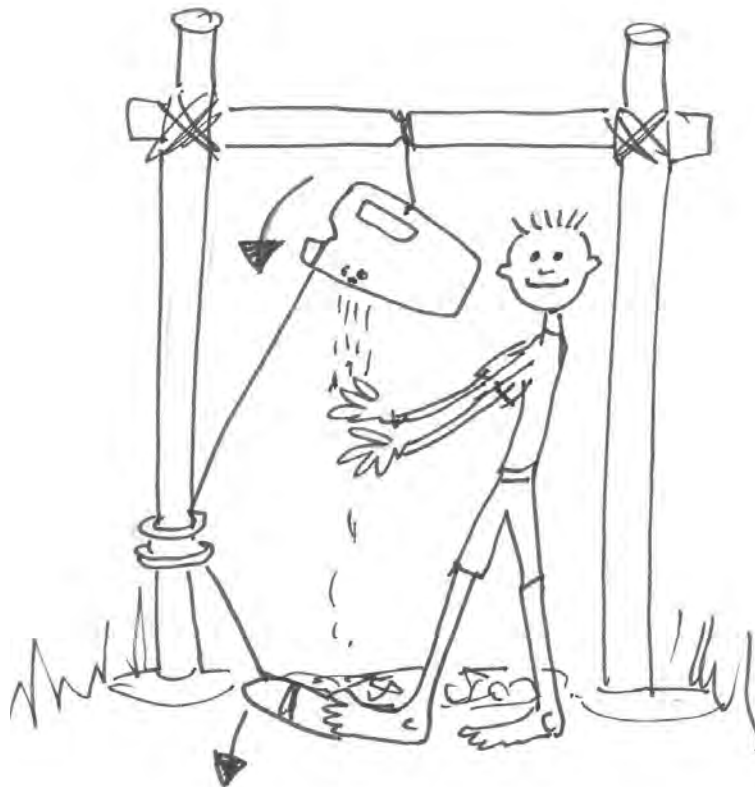

20. Afterwards you can add a soap dish made from a water bottle.





# Session 9: Toy Car

Message: Making toys is good for us.

## Important words:

**Roller:** long thin cylinder shape used to move heavy objects.

**Thrust :** the force that pushes something forward.

**Jet power:** when air moves in one direction pushing an object in the opposite direction.

## English Vocabulary:

- wheel
- wheelbarrow
- cart
- bicycle
- rickshaw
- car
- bus
- boda boda
- truck
- pen
- balloon
- rubber band
- tape

## English Phrases:

Pass the X please.

## Activity 1: Introduction

1. Ask

- What did you learn in the last session?
- What did we make in the last session?
- What did we use to make it?
- What did you do with the things you made in the last session?
- Can you tell the class about it?

2. Say:

- Today we will learn how we can make a toy car
- We will also look at simple machines

3. Ask:

- Who has a toy car?
- Who has made a toy car?

## Activity 2: Science

1. Show a milk tin stool or a cooking oil container full of water to the class.

2. Ask a learner to move the stool/container from one side of the class to the other.

3. Ask:

- How easy is it to move the milk tin stool?
- Is there an easier way to move the milk tin stool?

4. Say:

- I am going to use these pencils to move the milk tin stool.

5. Put 4 pencils under the milk tin stool.

6. Ask a learner to push the milk tin stool.

7. Ask:

- How easy is it to move the milk tin stool?

8. Say:



- When we use a pencil under the milk tin stool, pushing it became easier.
  - The pencil acts as a roller.
  - Rollers make work easier.
  - We can move heavy objects using rollers.
9. Show how to move the pencils from the back of the milk tin stool to the front so the milk tin stool can continue to move.
10. Ask some learners to come to the front and use the pencils to move the milk tin stool to the other side of the room.
11. Ask:
- What can we use to make rollers?
12. Say:
- We can use smooth stems of bamboo or tree trunks to make rollers.

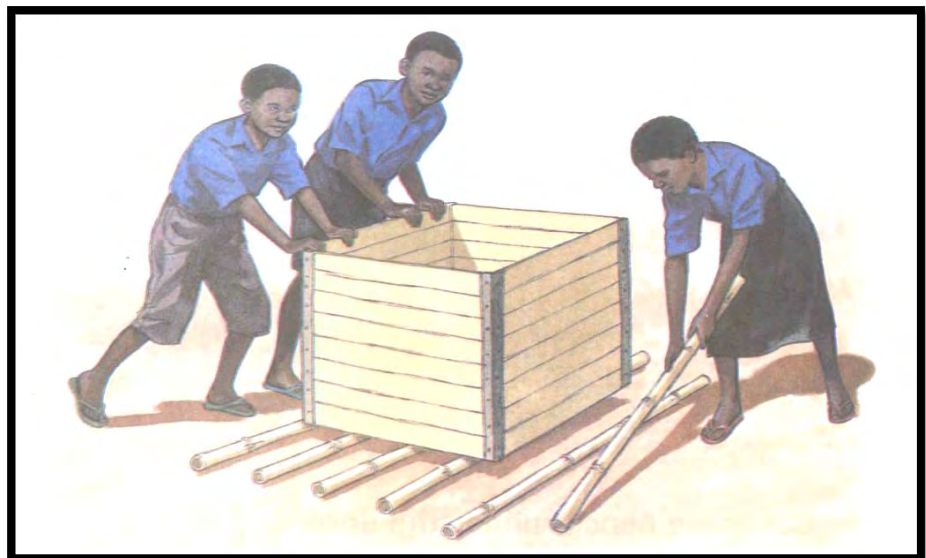

### Activity 3: **Wheels**

1. Say:
- A roller is a simple machine.
  - It helps us do a job better and faster.
  - Another simple machine is the wheel.
2. Ask:
- What shape is a wheel?
3. Say:
- A wheel is a circle shape.

- A circle moves easily down a slope and along the ground.

4. Ask:

- What else has a circle shape?

Answer: CD, sweets, bottle tops.

5. Ask the learners to draw as many things as they can that have wheels.

6. Ask the learners in turn to tell the things that have wheels.

7. Draw the following on the black board:

- Wheelbarrow
- Cart
- Bicycle
- Rickshaw
- Car
- Bus
- Boda boda
- Truck

8. Say:

- Let's learn the English words.

9. Point to each picture in turn and say:

- This is a **wheelbarrow**.
- This is a **bicycle**.
- This is a **boda boda**
- This is a **cart**.
- This is a **rickshaw**.
- This is a **car**.
- This is a **truck**.
- This is a **bus**.

10. Point to a picture and ask:

- What is this?
- Learners should respond in English: This is a \_\_\_\_\_ .

11. Repeat with 5-10 learners.

12. Select a learner. Say:

- Find a **bus**.
- Find a **bicycle**.
- Find a **car**.
- Find a **wheelbarrow**.
- Find a **truck**.
- Find a **boda boda**.
- Find a **cart**.
- Find a **rickshaw**.

13. Say:

- How many wheels does a wheelbarrow have?
- Lets count the wheels

14. Repeat for each picture. Remember that a car, cart, rickshaw bus and truck will have wheels on both sides.

15. Ask:

- Which has the most wheels?
- Which has the least wheels?

16. Count the wheels on a truck. Six on one side and six on the other side.

17. Ask:

- How many wheels does an airplane have?

Answer: 2 wheels to help it land and one small wheel at the front

18. Say:

- A wheel is a simple machine that we use every day.
- Our work is easier when we use wheels.

## Activity 4: **Beat the Words**

1. Say the first vocabulary word. Ask the learners to repeat it after you.

2. Say:

- Listen while I clap the syllables in this word.

### **Teaching Syllables:**

#### **Syllables in Vocabulary Words**

- **rol / ler** : 2 syllables = 2 claps
- **wheel**: 1 syllable = 1 clap
- **wheel / bar / row**: 3 syllables = 3 claps
- **car**: 1 syllable = 1 clap
- **bus**: 1 syllable = 1 clap
- **truck**: 1 syllable = 1 clap
- **cart**: 1 syllable = 1 clap
- **rick / shaw** : 2 syllables = 2 claps
- **bi / cy / cle** 3 syllables = 3 claps
- **bo / da / bo / da** 4 syllables = 4 claps
- **air / plane** : 2 syllables = 2 claps

3. Say the word again while clapping the syllables.

4. Repeat with learners.
5. Ask learners to identify the number of syllables in the word.
6. Use your fingers to count the number of syllables together with the class.
7. Repeat with the other vocabulary words.

**Materials for  
activity 5:**

Plastic bottle  
5 Plastic bottle  
lids  
2 sticks  
String  
Metal bottle tops  
Toolkit  
Rubbish bin

## Activity 5: Preparation

1. Put the learners into a large circle.
2. Say:
  - We are going to prepare to make a toy car from a water bottle.
3. Show the items needed to make the toy car from a water bottle:
  - Plastic bottles
  - 5 plastic bottle lids
  - 2 sticks
  - String
  - Metal bottle tops
  - Marker pen
  - Knife
  - Nail
  - Scissors
  - Rubbish bin
4. Point to the item and ask:
  - What is this?
  - Learners should respond in English: This is a \_\_\_\_\_ .
7. Repeat with 5-10 learners.
8. Ask:
  - Is the space safe?
  - Is your body safe? Are you dressed correctly?
8. Remind the learners of the Skills for Life Plus rules.
9. Ask the learners to make their body and the space safe.
10. Read out the key message:

**Making toys is good for us.**
11. Repeat with learners
12. Say the key message to the music beat.
13. Repeat with learners.

## Activity 6: **Demonstration**

### **Materials for activity 6:**

Plastic bottle

5 Plastic bottle lids

2 sticks

String

Metal bottle tops

Toolkit

Rubbish bin

1. Say:

- I am going to show you how to make a toy car from a water bottle
- Look carefully at what I do.

2. Say:

- Remember: Use a rubbish bin. A messy space is dangerous.

3. Follow the instructions to make a toy car.

4. When you have finished put all the waste pieces in the rubbish bin.

5. Ask a learner to pull the toy car across the classroom.

6. Say:

The wheels make it easy to pull the toy car.

7. Read out the key message:

**Making toys is good for us.**

8. Repeat with learners.

9. Say the key message to the music beat.

10. Repeat with learners.

# How to make a toy car from a water bottle

## Materials

Water bottle  
String  
5 bottle tops  
2 sticks  
Nail  
Marker pen  
Knife  
Scissors

1. Mark a dot at each end of the water bottle in a line.
2. Use a knife to make a small cut on the dot and push the nail through to make a hole.
3. Where the nail touches the bottle at the same level as the hole, mark a dot. Do this for the 2 holes.
4. Use a knife to make a small cut on the dot and push the nail through to make a hole.
5. Mark a dot in the middle of each bottle top.
6. Make a hole in the middle of each bottle top.
7. Take the string and tie a knot at one end.
8. Thread the other end through one bottle top.
9. Put the top on the bottle tightly.
10. Put the stick through one bottle top then through 2 holes in the water bottle.
11. Put a second bottle top on the end of the stick.  
If the stick is too long, take the bottle top off then cut the stick shorter with the knife.
12. Repeat with the other bottle tops and stick.
13. Now you have a toy car.
  
14. Carefully mark a square shape on top of the water bottle.
15. Use the knife to make a hole on one side of the square. Then use the scissors to cut the square shape out.
16. Put the metal bottle tops through the hole.
17. Now pull your toy car.

# How to make a toy car from a water bottle

## Materials

Water bottle  
String  
5 bottle tops  
2 sticks  
Nail  
Marker pen  
Knife  
Scissors

1. Mark a dot at each end of the water bottle in a line.
2. Use a knife to make a small cut on the dot and push the nail through to make a hole.

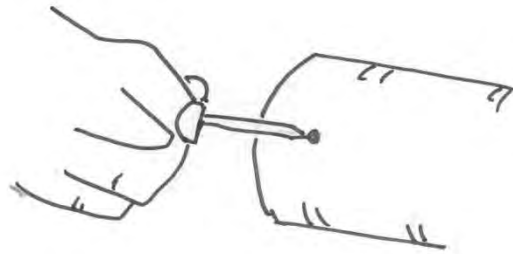
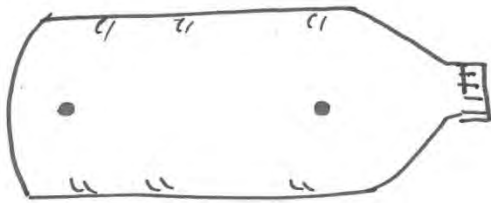

3. Where the nail touches the bottle at the same level as the hole, mark a dot. Do this for the 2 holes.

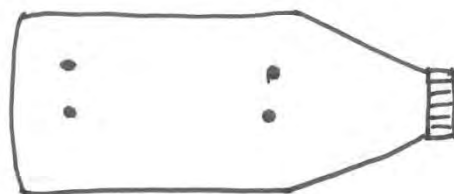
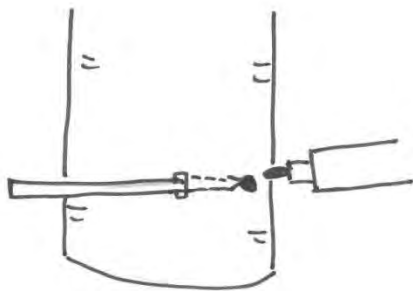

4. Use a knife to make a small cut on the dot and push the nail through to make a hole.
5. Mark a dot in the middle of each bottle top.

6. Make a hole in the middle of each bottle top.

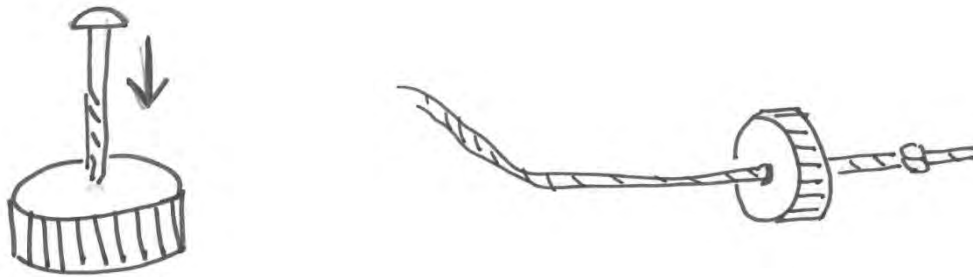

7. Take the string and tie a knot at one end.

8. Thread the other end through one bottle top.

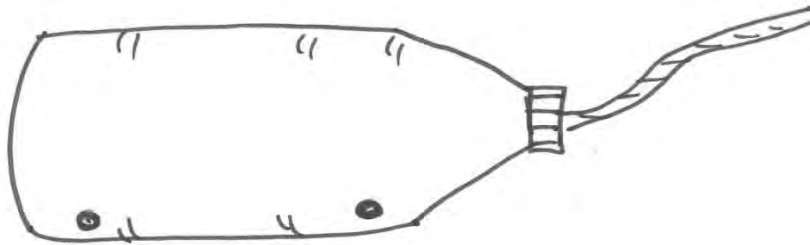

9. Put the top on the bottle tightly.

10. Put the stick through one bottle top then through 2 holes in the water bottle.

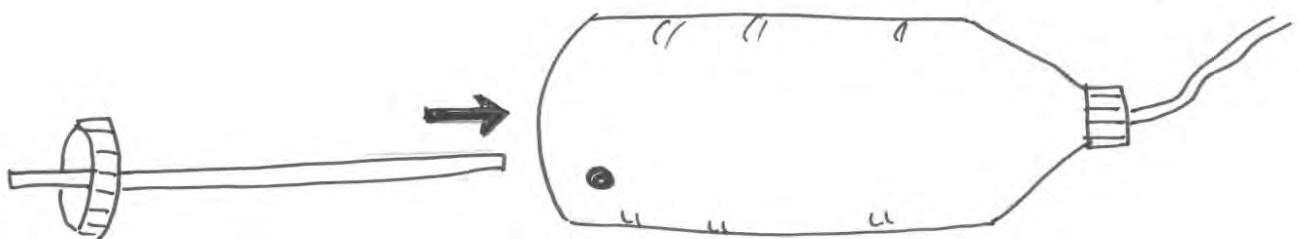

11. Put a second bottle top on the end of the stick.

If the stick is too long, take the bottle top off then cut the stick shorter with the knife.



12. Repeat with the other bottle tops and stick.

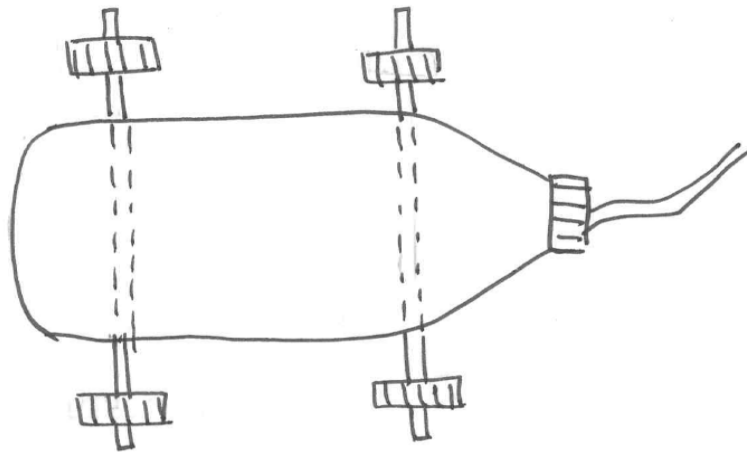

13. Now you have a toy car.

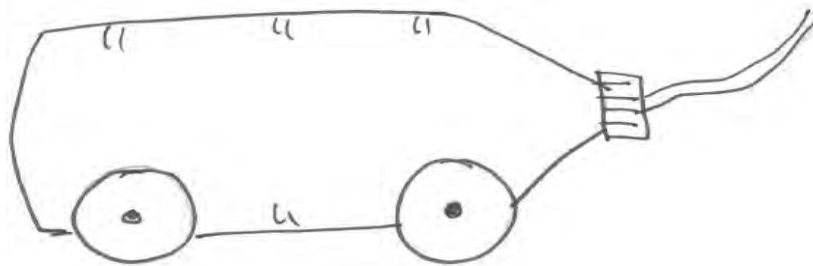

14. Carefully mark a square shape on top of the water bottle.

15. Use the knife to make a hole on one side of the square. Then use the scissors to cut the square shape out.

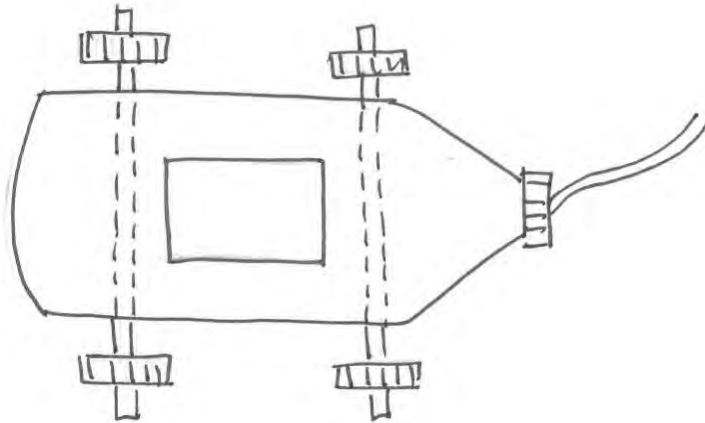

16. Put the metal bottle tops through the hole.

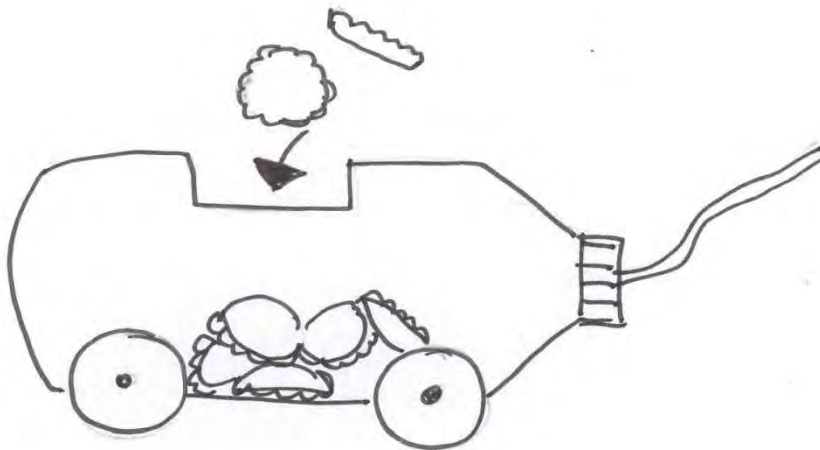

17. Now pull your toy car.



**Materials for activity 7:**

Plastic bottle

5 Plastic bottle lids

2 sticks

String

Metal bottle tops

Toolkit

Rubbish bin

## Activity 7: Making a Toy Car

1. Put the learners into 5 groups.
2. Ask learners to put all their materials together on the floor.
3. Say:
  - If your group has a lot of materials then you can try to make one toy car each.
  - If you group has only a few materials then everyone will work together to make one toy car.
  - Each person in the group will cut a circle of inner tube in turn and knot it the jump rope.
  - Decide who will:
    - Make the hole in the water bottle.
    - Make the holes in the 5 water bottle tops.
    - Put the string in the lid and knot it.
    - Put the lids on the sticks in the water bottle.
    - Make the holes in the top.
    - Put in the metal bottle tops.
4. Say:
  - We need to take it in turns to use the scissors, the knife and the nail.
  - Remember to ask “Can I have the scissors please?”
  - Remember to pass the scissors and knife safely.
5. Give a toolkit to each group.
6. Say:
  - Each group can make their toy car.
7. Monitor the groups and provide help when needed. Make comments to the group:
  - I like the way you are helping each other.
  - I like the way you are asking for the nail in English.
  - I like the way you are being careful with the scissors.
8. When everyone has finished collect the tools.
9. Ask each group in turn to show their toy cars.
10. Ask:
  - How do you feel now that you have made a toy car?
  - Who would you like to give your toy car to?
  - How does it feel to give a toy car to someone you care about?
11. Say:
  - We may be too old to play with a toy car.
  - Our younger sisters and brother will be very happy to play with a toy car.

- Making a toy car for younger brothers and sisters show that we care for them.
- Making a toy car is also good for our self-esteem. It makes us feel good about ourselves and that we can create and make something for others.

12. Read out the key message:

**Making toys is good for us.**

13. Repeat with learners

14. Say the key message to the music beat.

15. Repeat with learners.

**Materials for activity 8:**

Ball point pen

Balloon

Rubber band

Tape

Toolkit

Rubbish bin

## Activity 8: Jet Powered Toy Car

1. Put the learners into a large circle.

2. Ask:

- How can we make the toy car move if we cannot pull or push it?

3. Say:

- We are going to make a jet car.
- Jet power is when air moves in one direction pushing the car in the opposite direction.
- Jet planes use this type of power.

4. Show the items needed to make the jet car.

- Outside of a biro or ball point pen
- Balloon
- Rubber band
- Sticky tape
- Nail

5. Point to an item and ask:

- What is this?
- Learners should respond in English: This is a \_\_\_\_\_ .

6. Repeat with 5-10 learners.

7. Say:

- Let's learn the English words.

8. Point to each item in turn and say:

- This is a **pen**.
- This is a **balloon**.
- This is a **rubber band**.
- This is **tape**.

9. Point to an item and ask: :What is this?

- Learners should respond in English: This is a \_\_\_\_\_ .

11. Repeat with 5-10 learners.

12. Select a learner. Say:

- Find a **balloon**.
- Find a **rubber band**.
- Find a **pen**.
- Find a **tape**.

13. Ask:

- Is the space safe?
- Is your body safe? Are you dressed correctly?

14. Remind the learners of the Skills for Life Plus rules.

15. Ask the learners to make their body and the space safe.

**Materials for  
activity 9:**

Ball point pen

Balloon

Rubber band

Tape

Toolkit

Rubbish bin

## Activity 9: **Demonstration**

1. Say:

- I am going to show you how to make a jet car.
- Look carefully at what I do.

2. Say:

- Remember: Use a rubbish bin. A messy space is dangerous.

3. Follow the instructions to make a jet car.

4. When you have finished put all the waste pieces in the rubbish bin.

5. Show how the jet car works:

- Blow up the balloon through the pen.
- Put your finger over the end of the pen to stop the air escaping.
- Put the jet car on a smooth surface.
- Then let go.

6. Say:

- The jet car uses jet power to move.
- The air stored in the balloon pushes through the pen.
- This creates thrust which is the force that pushes the car forward.
- The air from the balloon moves in one direction and pushes the car in the opposite direction.

7. Read out the key message:

**Making toys is good for us.**

8. Repeat with learners

9. Say the key message to the music beat.

10. Repeat with learners.

# How to make a jet car

## Materials

Toy car made from a water bottle

Outside of a ball point pen

Balloon

Rubber band

Tape

1. Blow up the balloon and let it down three times. Be careful not to burst the balloon.
2. Take the end off and the middle out of the pen to leave a tube.
3. Put the balloon on the end of the pen.
4. Use the rubber band and the tape to attach the balloon to the pen. Make sure no air can get out.
5. Take the lid with the string off the bottle.
6. Put a the pen in the bottle and make a mark where it touches the top.
7. Use the knife to make a small cut and put the nail in to make a hole.
8. Put the pen with the balloon on through the hole at the top and out of the bottle top.
9. If the pen moves, use tape to keep it in place.
10. Now our jet car is ready to test.
  
11. Carefully blow up the balloon through the pen.
12. Put your finger over the end of the pen to hold the air in the balloon.
13. Now let go and watch you jet car go.

# How to make a jet car

## Materials

Toy car made from a water bottle

Outside of a ball point pen

Balloon

Rubber band

Tape

1. Blow up the balloon and let it down three times. Be careful not to burst the balloon.

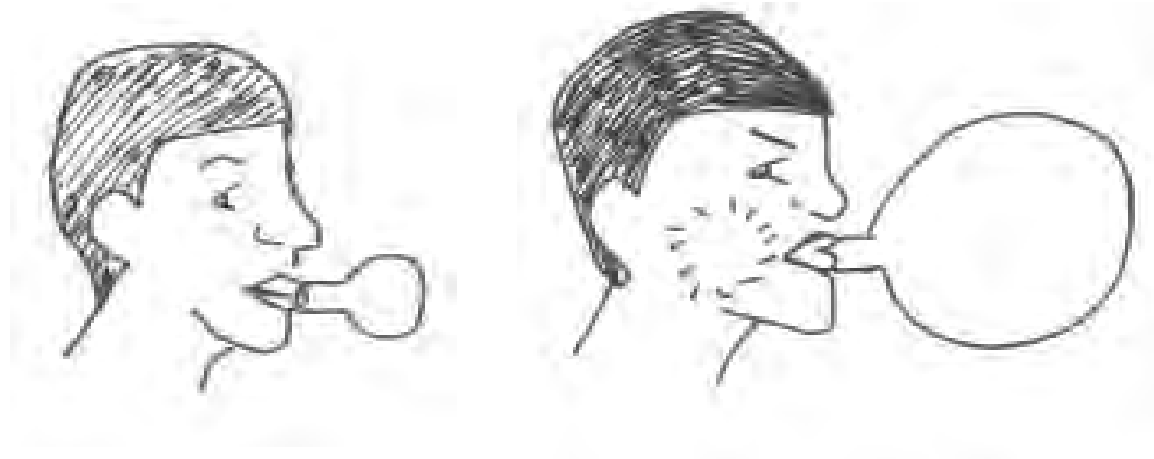

2. Take the end off and the middle out of the pen to leave a tube.

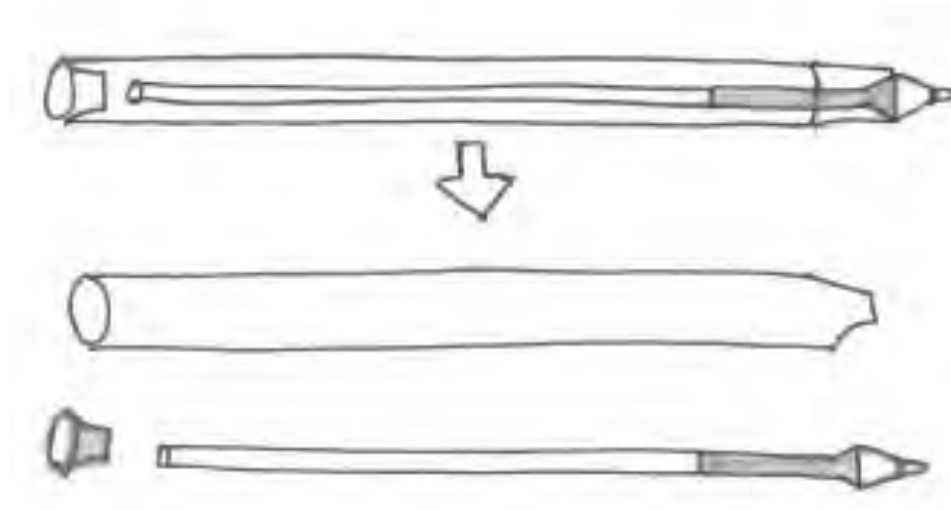

- Put the balloon on the end of the pen.

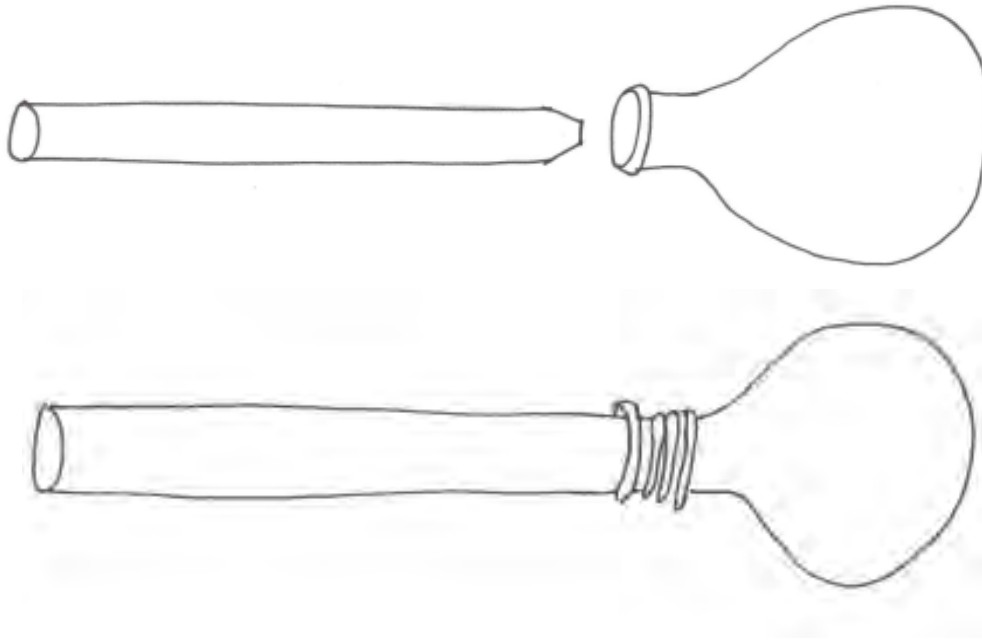

- Use the rubber band and the tape to attach the balloon to the pen. Make sure no air can get out.
- Take the lid with the string off the bottle.
- Put the pen in the bottle and make a mark where it touches the top.

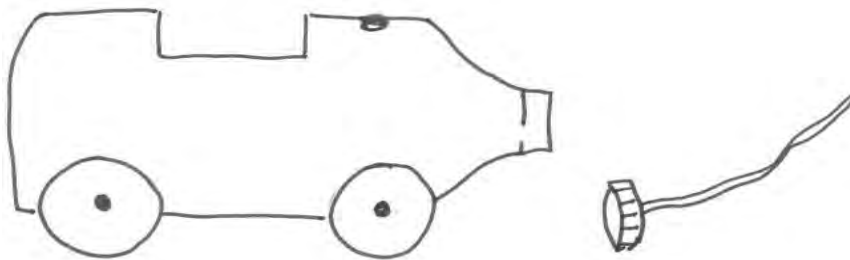

- Use the knife to make a small cut and put the nail in to make a hole.



- Put the pen with the balloon on through the hole at the top and out of the bottle top.

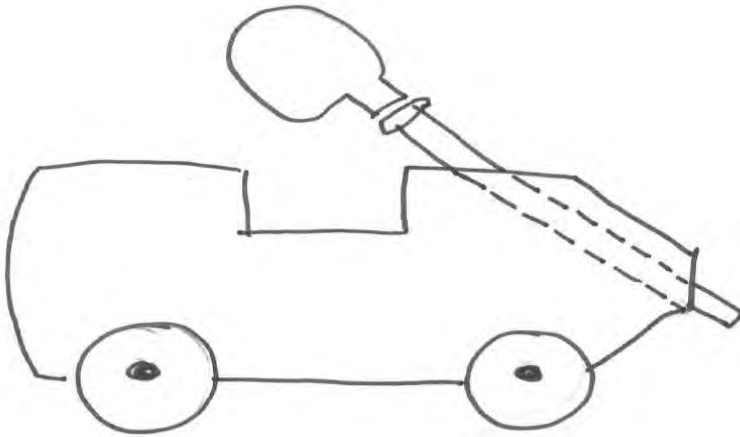

- If the pen moves, use tape to keep it in place.

10. Now our jet car is ready to test.

- Carefully blow up the balloon through the pen.

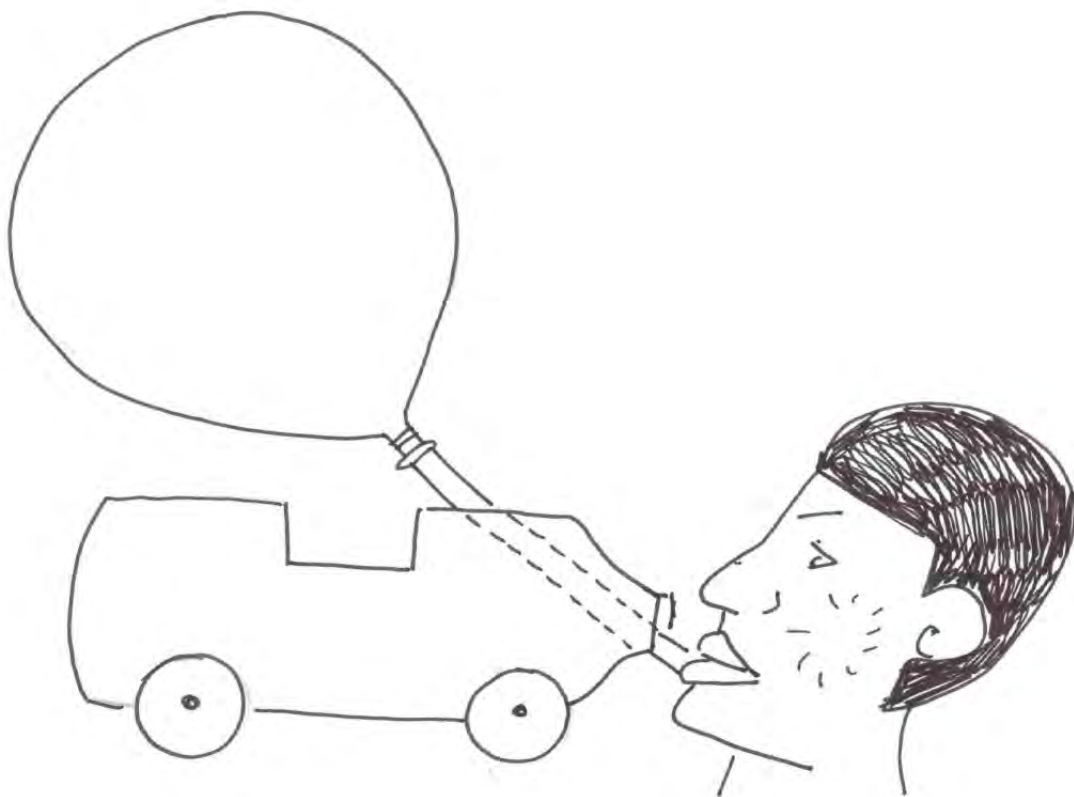

12. Put your finger over the end of the pen to hold the air in the balloon.

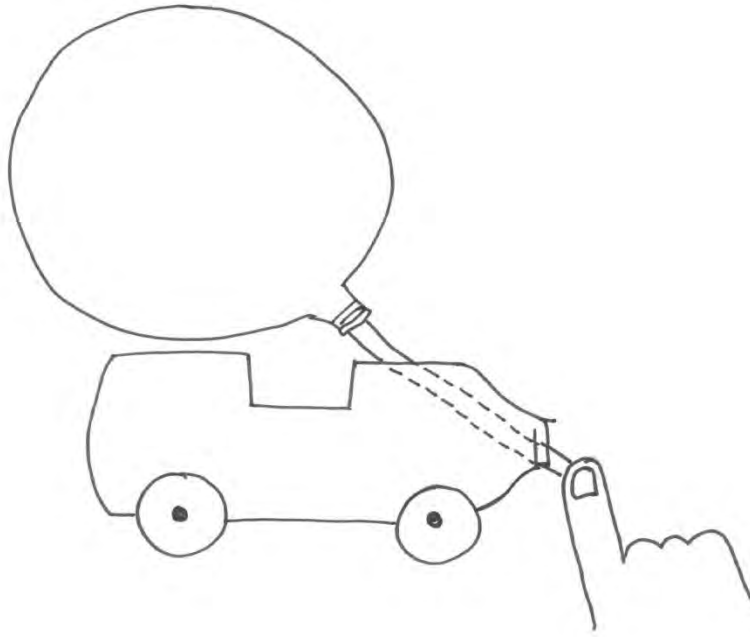

13. Now let go and watch your jet car go.





**Materials for activity 10:**

Ball point pen

Balloon

Rubber band

ape

Toolkit

Rubbish bin

## Activity 10: Making a jet car

1. Put the learners into 5 groups.
2. Ask learners to put their materials on the floor next to the toy car.
3. Say:
  - If your group has a lot of materials then you can try to make one jet car each.
  - If you group has only a few materials then everyone will work together to make one jet car.
  - Decide who will:
    - Put the balloon on the pen.
    - Push the pen in the bottle.
    - Blow up the balloon and let the jet car go.
4. Say:
  - We need to take it in turns to use the tape.
  - Remember to ask “Can I have the tape please?”
5. Give a toolkit to each group.
6. Say:
  - Each group can make their jet car.
7. Monitor the groups and provide help when needed. Make comments to the group:
  - I like the way you are helping each other.
  - I like the way you are being careful.
8. When everyone has finished collect the tools.
9. Ask each group in turn to show their jet cars.
10. Have a competition between groups to see which jet car travels the furthest.

## Activity 11: Key Message

1. Ask learners if they remember the key message.
2. Write the key message on the blackboard.

**Making toys is good for us.**
3. Read the message. Move your finger under each word as you read it.
4. Ask learners to say the message with you. Point to each word as you read it together.
5. Ask different learners to read the message.
6. Ask learners to come to the front and underline a word in the message such as: toys, good, making.

7. Ask learners to copy the message and draw a picture to go with it.

**Materials for activity 12:**

Stones or sticks  
3 pots made from water bottles with a happy, normal and sad face



## Activity 12: **Assessment**

1. Put learners into groups of 2.
2. Ask each group of 2 learners to talk about the following questions:
  - What 2 things did you learn today?
  - What did you like doing the best?
  - What will you tell and show your family about today?
3. Ask some groups to share their answers with the class.
4. Find three places on the floor or use 3 pots and mark them: happy face, normal face and sad face.
5. Ask each learner to put a stone or stick next to the place that shows how they felt about the session.
6. Write down how many learners put a stone next to each face in order to keep track of which lessons work well and which lessons could be improved.

# Session 10: Water Bottle Mouse Trap

**Message:** Prevent disease spreading – trap mice.

## Important words:

**Machine:** a tool containing one or more parts that does a job better and faster and more powerfully than a human being.

## English Vocabulary:

- tree
- flag
- classroom
- compound
- door
- window

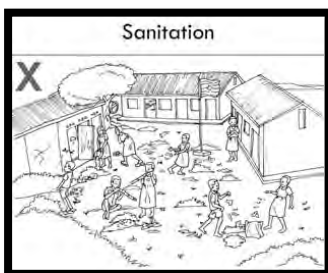

## Activity 1: Introduction

1. Ask

- What did you learn in the last session?
- What did we make in the last session?
- What did we use to make it?
- What did you do with the things you made in the last session?
- Can you tell the class about it?

2. Say:

- Today we learn how to make a simple machine that will trap mice.
- We will also look at sanitation and how to improve our environment.

3. Ask:

- How clean is the area around your home or tent?
- Who is responsible for keeping it clean?

## Activity 2: Sanitation

1. Put the learners into a large circle.

2. Hold up the chart from Module 4 Session 5: Sanitation.

3. Read the title. Move your finger under each word as you read it.

4. Ask:

- What do you see?
- What is the girl doing?
- Do you like this school? Why?

5. Point to different things in the picture and ask:

- What is this?
- Learners should respond: This is a \_\_\_\_\_ .

6. Say:

- Let's learn the English words.

7. Point to each item in turn and say:

- This is a **tree**.
- This is a **flag**.
- This is a **classroom**.
- This is a **door**.
- This is a **window**.
- This is a **compound**.

8. Point to the item and ask:

- What is this?
- Learners should respond in English: This is a \_\_\_\_\_ .

9. Repeat with 5-10 learners.

10. Select a learner. Say:

- Find the **door**.
- Find the **flag**.
- Find the **classroom**.
- Find the **tree**.
- Find the **window**.
- Find the **compound**.

11. Repeat with 5-10 learners.

12. Ask:

- What is in the compound?
- How does the compound smell?
- What problems will children have playing in this compound?

13. Point to the broken glass and ask:

- What is this?
- What problems can happen?
- What should we do with it?

14. Repeat for:

- Stagnant water puddle
- Old food

15. Say: A dirty compound:

- can lead to injury from broken glass or metal.
- has stagnant water where mosquitoes breed.
- has old food that rats and mice eat. They can spread disease.
- has old food that encourages flies which can spread disease.
- has animal or human faeces that flies land on and spread disease.

16. Ask:

- What can you do to make the compound clean and safe?

17. Say:

- Sweep the compound.
- Remove the rubbish to a rubbish pit and burn it.
- Clean the latrine.
- Keep animals away from the latrine.
- Use the latrine correctly.
- Use nets on windows and door to stop insects.
- Trap rats and mice.

18. Say:

- Practicing good sanitation and cleaning our compound can lead to healthier lives.
- To reduce mice and rats we need to remove their source of food.
- We can also make a mouse trap from a water bottle.

19. Read out the key message:

**Prevent disease spreading – trap mice.**

20. Repeat with learners.

21. Say the key message to a music beat.

22. Repeat with learners.

## Activity 3: **Beat the Words**

1. Say the first vocabulary word. Ask the learners to repeat it after you.

2. Say:

- Listen while I clap the syllables in this word.

### **Teaching Syllables:**

#### **Syllables in Vocabulary Words**

- **class / room:** 2 syllables = 2 claps
- **com / pound:** 2 syllables = 2 claps
- **win / dow:** 2 syllables = 2 claps
- **door:** 1 syllable = 1 clap
- **tree:** 1 syllable = 1 clap
- **flag:** 1 syllable = 1 clap
- **mouse / trap:** 2 syllables = 2 claps
- **san / i / ta / tion:** 4 syllables = 4 claps



3. Say the word again while clapping the syllables.
4. Repeat with learners.
5. Ask learners to identify the number of syllables in the word.
6. Use your fingers to count the number of syllables together with the class.
7. Repeat with the other vocabulary words.

**Materials for  
activity 4:**

Plastic bottle

2 sticks

String

2 rubber bands

Paper clip

Toolkit

Rubbish bin

## Activity 4: Preparation

1. Put the learners into a large circle.
2. Say:
  - We are going to prepare to make a mouse trap.
3. Show the items needed to make a mouse trap.
  - Plastic bottle
  - 2 sticks
  - String
  - 2 rubber bands
  - Paper clip or wire
  - Scissors
  - Knife
  - Nail
  - Marker pen
  - Rubbish bin
4. Point to different things and ask:
  - What is this?
  - Learners should respond: This is a \_\_\_\_\_ .
5. Say:
  - Let's learn the English words.
6. Point to each item in turn and say:
  - This is a **rubber band**.
  - This is a **paper clip**.
  - This is a **nail**.
  - This is a **knife**.
7. Point to the item and ask:
  - What is this?
  - Learners should respond in English: This is a \_\_\_\_\_ .
8. Repeat with 5-10 learners.
9. Select a learner. Say:
  - Find the **paper clip**.
  - Find the **rubber band**.
  - Find the **knife**.

- Find the **nail**.

10. Repeat with 5-10 learners.

11. Say:

- Listen while I clap the syllables in this word.

### Teaching Syllables:

#### Syllables in Vocabulary Words

- **knife:** 1 syllable = 1 clap
- **nail:** 1 syllable = 1 clap
- **pa /per / clip:** 3 syllables = 3 claps
- **rub / ber / band:** 3 syllables = 3 claps

12. Say the word again while clapping the syllables.

13. Repeat with learners.

14. Ask learners to identify the number of syllables in the word.

15. Use your fingers to count the number of syllables together with the class.

16. Repeat with the other vocabulary words.

17. Ask:

- Is the space safe?
- Is your body safe? Are you dressed correctly?

18. Remind the learners of the Skills for Life Plus rules.

19. Ask the learners to make their body and the space safe.

#### Materials for activity 5:

Plastic bottle

2 sticks

String

2 rubber bands

Paper clip

Toolkit

Rubbish bin

## Activity 5: Demonstration

1. Say:

- I am going to show you how to make a water bottle mouse trap.
- Look carefully at what I do.

2. Say:

- Remember: Use a rubbish bin. A messy space is dangerous.

3. Follow the instructions to make a mouse trap.

4. When you have finished put all the waste pieces in the rubbish bin.

5. Read out the key message:

**Prevent disease spreading – trap mice.**

6. Repeat with learners.
7. Say the key message to a music beat.
8. Repeat with learners.
9. When you have finished pass the mouse trap around the circle.

**Materials for activity 6:**

Toolkit

Rubbish bin

Plastic bottle

2 sticks

String

2 rubber bands

Paper clip

## Activity 6: Making a Mouse Trap

1. Put the learners into 5 groups.
2. Ask learners to put all their materials like bottle, sticks, wire, together on the floor.
3. Say:
  - If your group has lots of bottles and sticks, then you can try to make one mouse trap each.
  - If your group only has a few materials, everyone in the group will work together to make one mouse trap.
  - Decide who will do each task to make the mouse trap.
4. Give a toolkit to each group.
5. Say:
  - Each group can make their mouse trap.
  - Remember to be careful with the knife, nail and scissors.
6. Monitor the groups and provide help when needed. Make comments to the group:
  - I like the way you are helping each other.
  - I like the way that you being careful with the nail.
  - I like the way you are checking the rubber band and string.
7. When everyone has finished collect the tools.
8. Ask each group in turn to show their water bottle mouse trap.
9. Ask:
  - How do you feel now that you have made a mouse trap?
  - What will you do with the mouse trap?
  - Where can we place the mouse traps in our class to catch a mouse?
10. Let the learners place the mouse traps in the class.
11. Say:
  - Every day we must remember to check the mouse traps.

## Activity 7: Key Message

1. Ask learners if they remember the key message.
2. Write the key message on the blackboard.  
**Prevent disease spreading – trap mice.**
3. Read the message. Move your finger under each word as you read it.
4. Ask learners to say the message with you. Point to each word as you read it together.
5. Ask different learners to read the message.
6. Ask learners to come to the front and underline a word in the message such as: disease, mice, trap.
7. Ask learners to copy the message and draw a picture to go with it.

### Materials for activity 8:

Stones or sticks  
3 pots made from water bottles with a happy, normal and sad face

## Activity 8: Assessment

1. Put learners into groups of 2.
2. Ask each group of 2 learners to talk about the following questions:
  - What 2 things did you learn today?
  - What did you like doing the best?
  - What will you tell and show your family about today?
3. Ask some groups to share their answers with the class.
4. Say:
  - In the next session we learn how to make a toy car.
  - We will need large and small plastic bottles. A square shaped plastic bottle is best.
  - We also need some small sticks 1 hand length long.
  - Each learner should try to bring 1 or 2 used plastic bottles and sticks to class.
5. Find three places on the floor or use 3 pots and mark them: happy face, normal face and sad face.
6. Ask each learner to put a stone or stick next to the place that shows how they felt about the session.
7. Write down how many learners put a stone next to each face in order to keep track of which lessons work well and which lessons could be improved.



# Plastic bottle mouse trap

Thanks to: Jong Chool Do [www.youtube.com/watch?v=QDgAuVK1Br0](http://www.youtube.com/watch?v=QDgAuVK1Br0)

## Materials

large plastic bottle  
2 wooden sticks  
2 rubber bands  
string  
paper clip or wire

## Tools

nail  
knife  
scissors  
marker pen

1. Make a mark on the bottle 1/3 of the way from the top.  
Draw around 3 sides of the bottle. Cut the bottle along the lines.

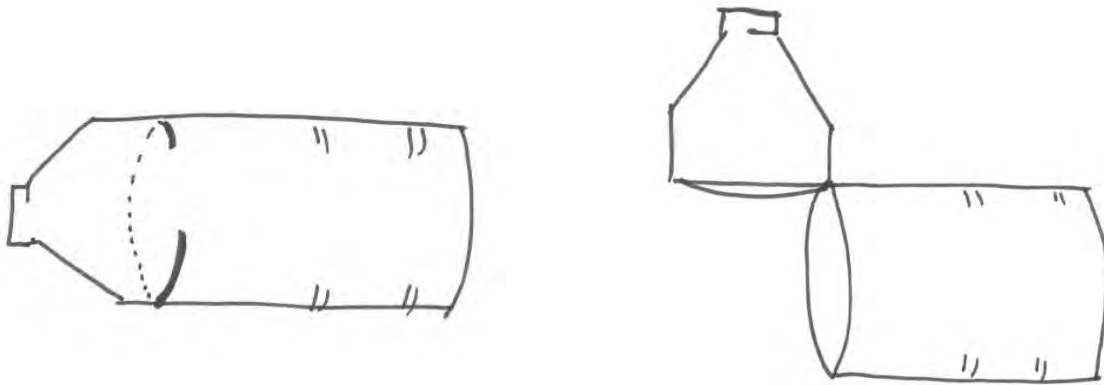

2. Open the bottle. The side, which has not been cut, acts as the hinge (pivot).
3. Make 2 holes in the side in the top part of the bottle with the nail.

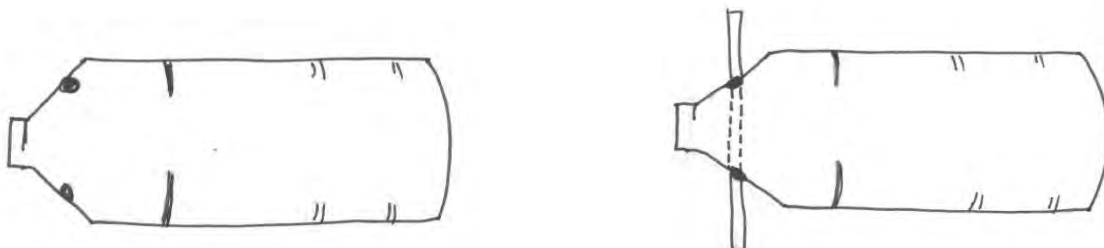

4. Thread a stick through the holes.

5. Check the position of the second holes. Take the elastic band and loop it over the stick. Pull it to the other end of the water bottle so it is tight but not too stretched. Mark this point.

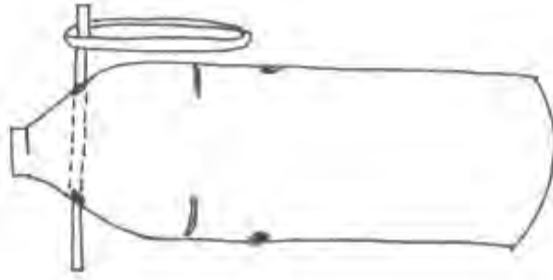

6. Make hole at this point on each side of the bottle.
7. Thread the second stick through the two holes. Trim the sticks leaving 2 cm sticking outside the bottle.

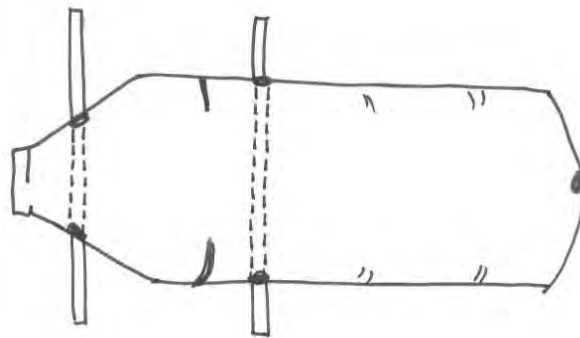

8. Place the bottle on the table with the uncut side of the bottle at the top. Make a hole in the base of the bottle about  $\frac{3}{4}$  from the bottom on the table.

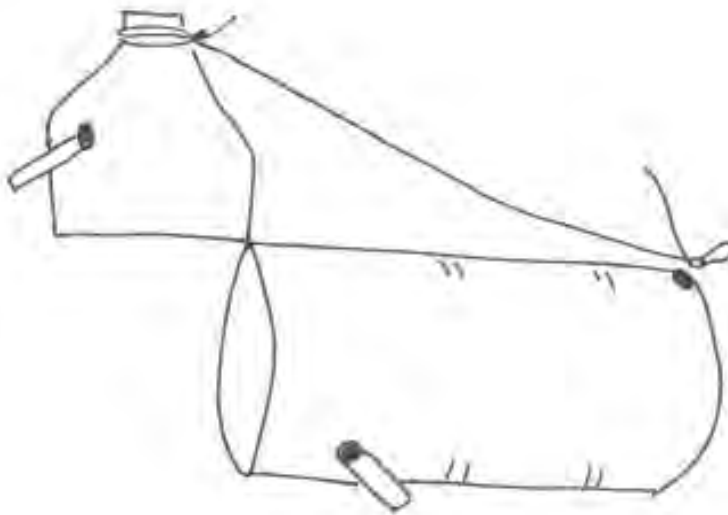

9. Take thread – Tie the thread firmly around bottle top end. Stretch the thread to the back of the bottle.
10. Pull the top end up with the thread. Measure the string to the hole at the bottom of the bottle.

11. Make a loop with a knot in the string at this point. Check the string with the hole again. If it is correct trim the string.

12. Take an elastic band. Stretch it around the two sticks on one side.

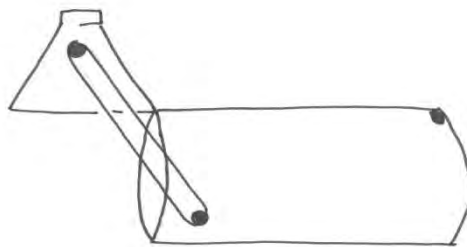
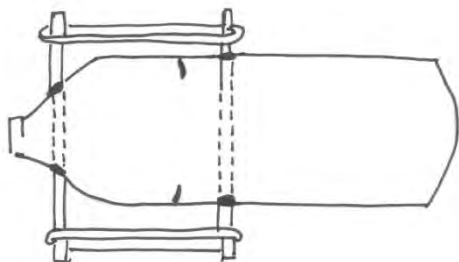

13. Take the second rubber band and do on the other side.

14. Pull up the top of the bottle. Check the elastic bands snap the bottle shut.

15. Untwist the paper clip, Bend the end of the paper clip/wire into a circle.

16. Put on a piece of bait on the wire. Make sure it will not fall out.

Bait is food that the mouse likes to eat. You can use carrot, or pumpkin,

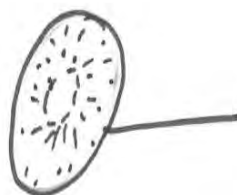

Put the hand holding the straight end of the paper clip into the bottle. Put the paper clip through the hole at the bottom of the bottle.

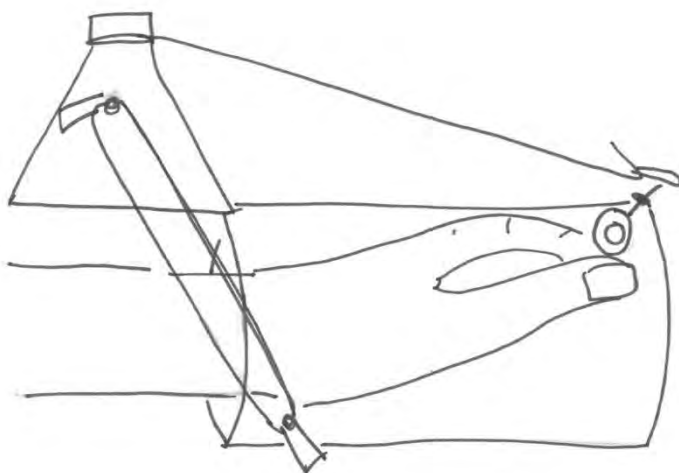

17. Loop the string over the end of the paper clip. Pull the top of the bottle up so the rubber bands are taut/tight.

18. Test the mouse trap. Pull the bait out.  
The bottle top should snap on your arm

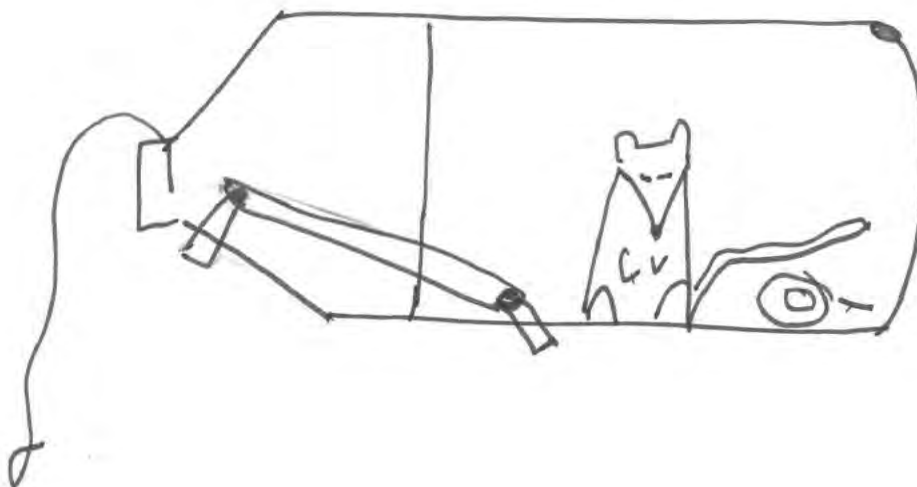
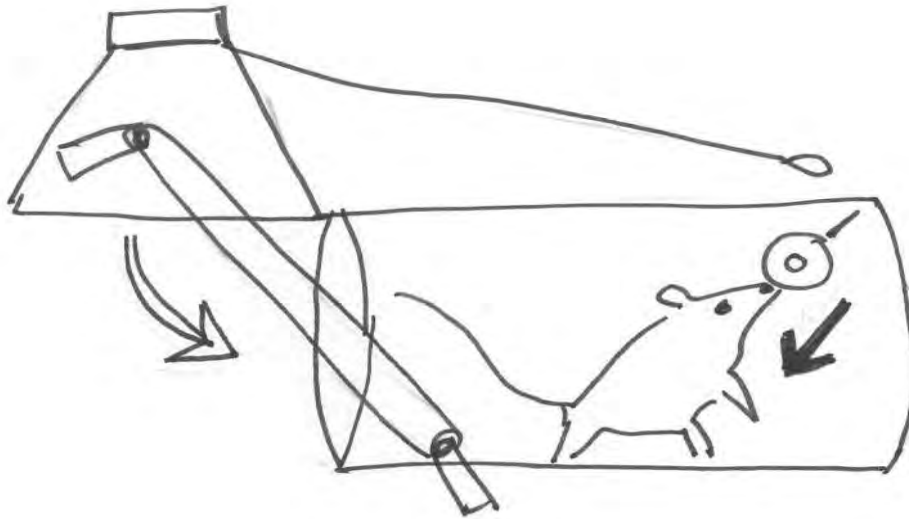
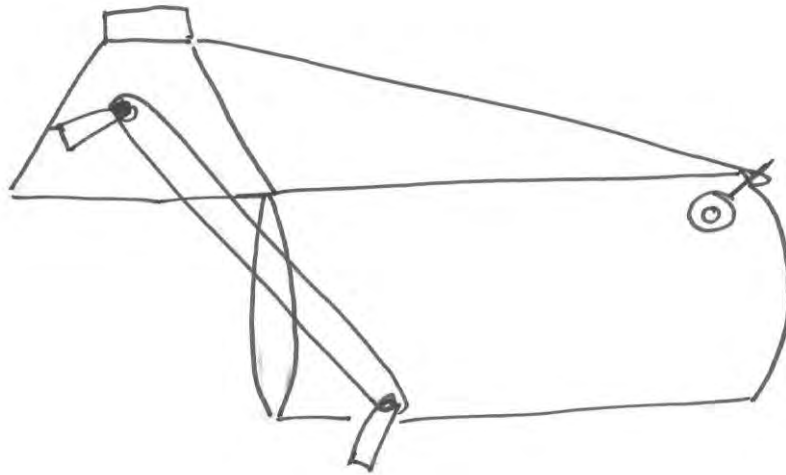



# The mouse trap in action

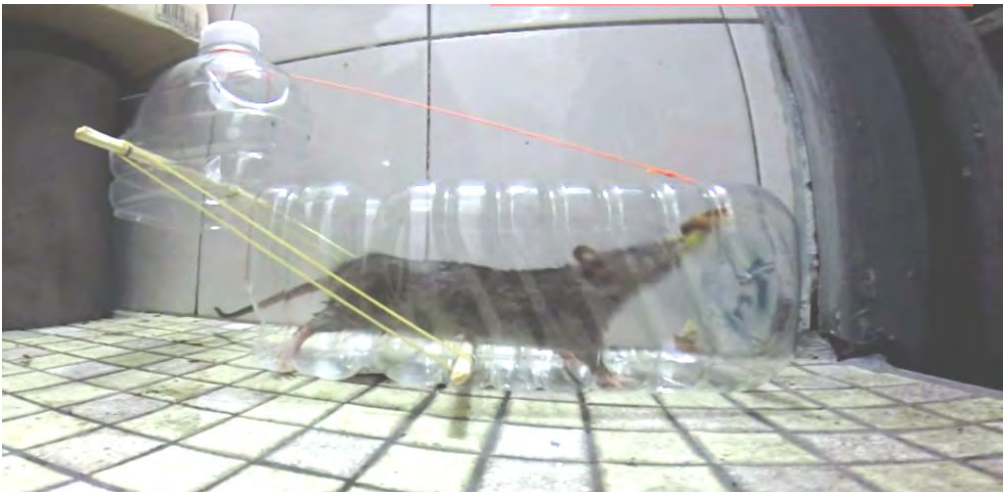
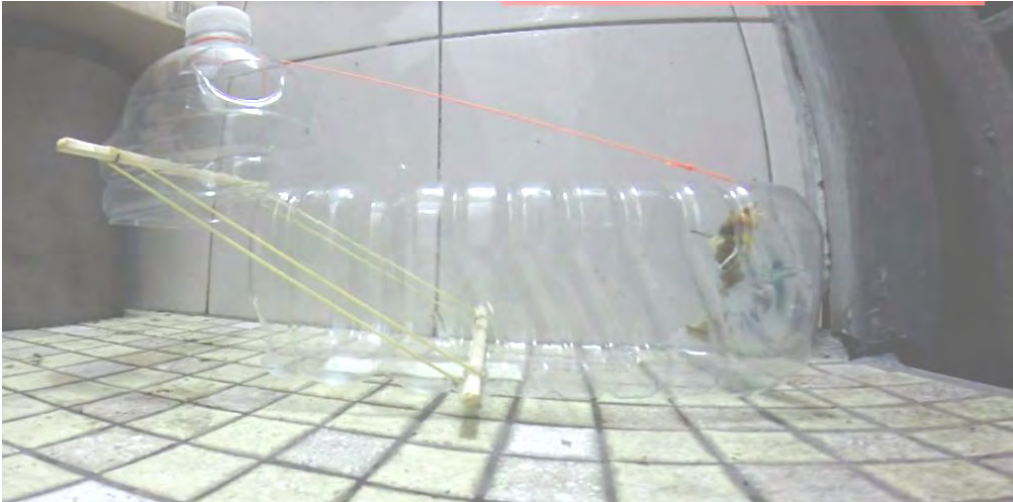

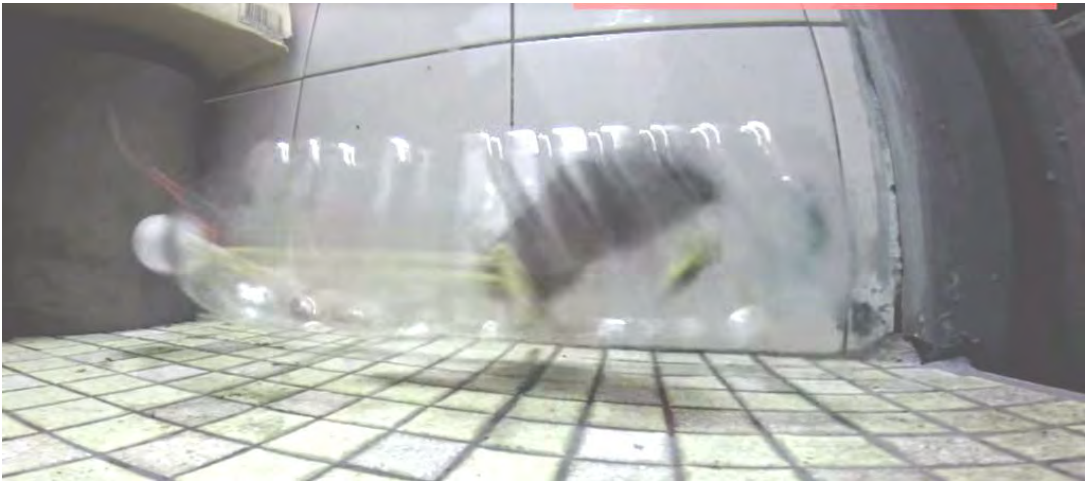
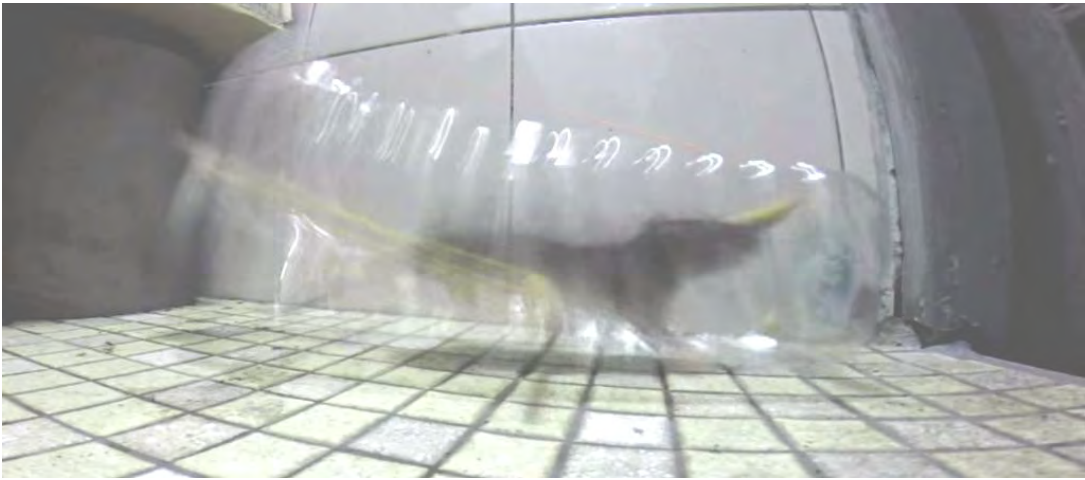
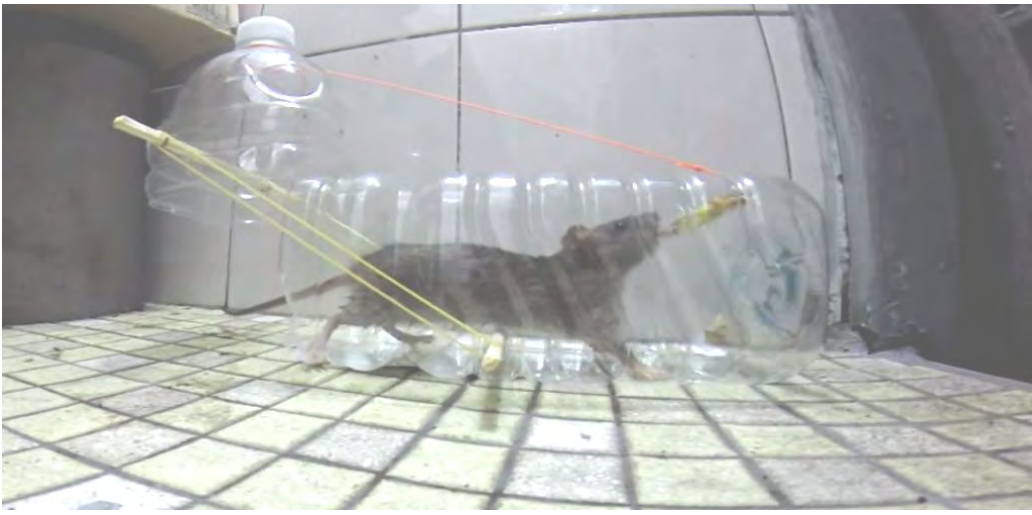

# Skills for Life + Learner Evaluation

**Teacher name** .....

**Class** ..... **Number of learners:** Total ..... boys: ..... girls: .....

**Purpose:** To assess learners' feelings about Skills for Life Plus as well as their learning

**Objectives:** Participate in the evaluation

**Time:** 30 minutes

**Materials:** Paper marked "no", "a little", "yes" and "a lot"

1. Ask the learners to stand up and go outside or move to the centre of the room.
2. Use a stick or chalk to divide the floor into 4 areas. Mark each area with a paper:
  - No
  - A little
  - Yes
  - A lot
3. Say:
  - I am going to read some sentences.
  - Think about each sentence.
  - Walk to the square that agrees with your answer.
  - When you have made you decision I will ask you why you chose this answer.
4. Read the following sentences and record the number of learners for each answer

		No	A little	Yes	A lot
1	Did you enjoy the Skills for Life plus course?				
2	Can you find the recycled materials needed to make things?				
3	Did you make a good toy car?				
4	Have the things we made in Skills for life plus helped improve your life? (Ask some participants for examples.)				
5	Did you take part in all the activities?				
6	Will you make SODIS water at home?				
7	Will you make and use a water bottle light?				
8	Will you make and use a tip-tap?				
9	Did you learn how to use scissors safely?				

10	Can you make your body safe when you make things? (Ask how they make their body safe)				
11	Did you learn how to make the learning space safe before you made things? (Ask how they make their body safe)				
12	Would you like to learn how to make more new things?				

Thank you for completing the evaluation. Please give the results to your Head teacher or the project officer responsible for Skills for Life +.





# South Sudan Teachers' Code of Conduct for Emergency Situations

## Introduction

This Teachers' Code of Conduct is designed to complement the *Southern Sudan Teachers' Professional Code of Conduct (2008)*. It is intended for use in emergency situations, where teachers might not be trained on the full Teacher Code of Conduct and where there are particular protection and safety concerns that teachers must be aware of.

The *Teachers' Code of Conduct for Emergency Situations* is designed to lay out the responsibilities of teachers in emergency situations and the relationship between teachers, learners, and the community during times of crisis and beyond. It also describes how teachers can support each other during emergency situations so that they can cope and contribute to the post-emergency recovery.

In this document, 'teacher' refers to any adult who is supervising learning in a classroom or temporary learning space. Often in emergency situations this might include formally trained government teachers or untrained trusted volunteers from the community.

Teachers have a very important role to play during emergency situations; this Code of Conduct is designed to support teachers in their work to continue providing protective education to the children of South Sudan during emergencies because they are our future.

South Sudan  
Education Cluster

## Responsibilities

### In the classroom, teachers...

- Must be present and on time for class. Any absence should be authorised and communicated to learners in advance. A class register should be taken.
- Must be prepared to teach and must not be under the influence of alcohol or drugs.
- Must promote a protective and positive learning environment however possible, being aware of risks in the area and respond or report security dangers.
- Should maintain political neutrality and promote peace and social responsibility.
- Are role models and should demonstrate good behaviour such as respect for others, hard work, punctuality, responsibility and team work.
- Display a basic competence in educational methods and the subjects to be taught, using lesson plans or schemes of work if possible.
- Provide basic information about emergency risks and life skills (e.g., landmine awareness, hand washing, disaster preparedness) and discuss children's fears openly.

### Teachers must do no harm...

- Respect learners' rights and dignity without discrimination according to gender, tribe, language, religion, age or ability.
- Do not use any actions or language that is physically or psychologically violent, which includes sexual harassment.

### A teacher should provide care and support...

- Teachers must wherever possible try to protect themselves and learners from dangers and make sure that emergencies do not interfere with learning or risk health and safety.
- Provide a learning environment where there is trust and where everyone is respected.
- Promote learners' self-esteem, confidence and self-worth. Encourage children to play.
- Promote high expectations of learners and help each student to reach his/her potential even in difficult circumstances.
- Listen to and observe learners who have experienced stressful events and provide support.
- Where necessary, refer the learner to other colleagues or supportive community members, respecting the privacy and wishes of the child.

### A teacher should use appropriate discipline...

- No physical punishment, shaming or humiliation (such as caning, making children kneel down, pinching the ears of children, scratching, or name calling) is permitted. In emergency situations learners are already exposed to physical risks and stress outside the classroom – school must be a safe place to be.
- Teachers try to understand inappropriate behaviour and provide guidance and support to address the cause of the problem.

## Relationships

### Teacher – Learner

- Teachers encourage both boys and girls to participate fully in all learning opportunities.
- Teachers should try to include children who might find it difficult to attend classes during emergencies – girls, children with disabilities or other vulnerable groups.
- Teachers shall never use physical, verbal, psychological or sexual violence against any learners.
- Teachers must never have any kind of sexual relationship with a learner. Both forced and agreed sexual relations are illegal and abusive. See right for mandatory penalties.

### Teacher – Community

- Teachers encourage parents to support and participate in their children's learning, both boys and girls.
- Teachers recognise the importance of family and community involvement in school.
- Teachers support and promote a positive image of the school within the community.

### Teacher – Teacher

- Teachers respect each other's rights and dignity without discrimination according to gender, tribe, language, religion, age or ability.
- In emergencies, even experienced teachers might find it difficult to cope with the crisis and the new challenges faced. Teachers can discuss challenges and stressful experiences, and support each other to set goals and address problems one at a time.

## Penalties for violating the Teachers' Code of Conduct

Teachers who do not meet the ethics and good practice laid out in this Code of Conduct will be disciplined either through suspension or termination of employment or other penalty agreed by the Headteacher, Parent Teacher Association, School Management Committee or Board of Governors and County Education Office, as appropriate. Legal prosecution may also be pursued.

## Signatures of commitment

Teacher name: .....

Signature: .....

Headteacher name: .....

Signature: .....

Chair of the PTA name: .....

Signature: .....

Minister of Education: H.E. Joseph Ukel Abango .....

Signature: .....

